

# MARVEL™

*SUPERHEROES*  
CAMPAIGN SET



**Machines of Doom**  
by Anthony Herring

-BUTLER-



# MARVEL™ SUPERHEROES CAMPAIGN SET

## Machines of Doom

by Anthony Herring

### Credits

**Design:** Anthony Herring

**Editing:** Steven E. Schend

**Art Coordinator:** Peggy Cooper

**Cover Art:** Jeff Butler

**Interior Illustrations:** Jerry Ordway & John Statemala

**Graphics Director:** Stephanie Tabat

**Typography:** Tracey Zamagne

**Cartography:** Dennis Kauth

**Production:** Paul Hanchette



TSR, Inc.  
P.O. Box 756  
Lake Geneva  
WI 53147  
U.S.A.



TSR Ltd.  
120 Church End,  
Cherry Hinton  
Cambridge CB1 3LB  
United Kingdom

This book is protected under the copyright laws of the United States of America. Any reproduction or unauthorized use of the material or artwork contained herein is prohibited without the express written consent of TSR, Inc. and Marvel Entertainment Group, Inc. Random House and its affiliate companies have worldwide distribution rights in the book trade for English language products of TSR, Inc. Distributed to the book and hobby trade in the United Kingdom by TSR, Ltd. Distributed to the toy and hobby trade by regional distributors. The names of the characters used herein are fictitious and do not refer to any persons living or dead. Any descriptions including similarities to persons living or dead are merely coincidental.

MARVEL SUPER HEROES, MARVEL UNIVERSE, DR. DOOM and all Marvel characters and the distinctive likenesses thereof are trademarks of Marvel Entertainment Group, Inc. and are used with permission. ©1992 Marvel Entertainment Group, Inc. All Rights Reserved.

The TSR logo is a trademark owned by TSR, Inc. Copyright ©1992 TSR, Inc. All Rights Reserved. Printed in U.S.A.

ISBN 1-56076-404-X

6906

# Table of Contents

<b>Preface and Introduction</b>	3	Inhibitor Ray	36
<b>Chapter 1: Inventing and Modifying Hardware</b>	4	Instant Hypnotism Impulser	37
Tech Rank	4	Insulato-Shield	37
The Resource FEAT	5	Intensified Molecule Projector	38
Special Requirements	6	Invincible Robot	38
Construction Time	7	Ionic Blade	40
The Reason FEAT	7	Latverian Guard Weaponry	40
Kit-Bashing	7	Memory Transference Machine	41
Modifying Hardware	8	Metabolic Transmuter	42
Damage	8	Micro-Sentry	42
Damage to Robots	9	Mini-Missile Launcher	43
Long-Term Repairs	9	Molecular Cage	43
Reprogramming	9	Molecule Displacer	43
Using Another Inventor's Creations	10	Multi-Dimensional Transference Center	44
Mixing Science and Sorcery	10	Nerve Impulse Scrambler	45
		Neuro-Space Field	45
		Neutro-Chamber	45
<b>Chapter 2: Doom's Technology Catalogue</b>	11	Omni-Missile	46
Air Cannon	13	Pacifier Robot	46
Amphibious Skycraft	13	Particle Projector	47
Antimatter Extrapolator	14	Plasteel Sphere	48
Aquarium Cage	14	Plasti-Gun	48
Armor, Doom's Original	14	Power Dampener	49
Armor, Doom's Promethium	17	Power Sphere	49
Bio-Enhancer	17	Power Transference Machine	50
Body Transferral Ray	17	Psionic Refractor	50
Bubble Ship	18	Psycho-Prism	51
Concussion Ray	18	Rainbow Missile	52
Cosmic-Beam Gun	19	Reducing Ray	52
Doombot	19	Refrigeration Unit	53
Doom-Knight	21	Ring Imperial	53
Doomsman I	22	Robotron	53
Doomsman II	23	Saucer-Ship	54
Doom Squad	23	Seeker	54
Electro-Shock Pistol	24	Silent Stalker	55
Electronic Shackle	25	Sonic Drill	55
Energy Fist	25	Spider-Finder	56
Enlarger Ray	25	Spider-Wave Transmitter	56
Excavator	25	Stasis Gun	56
Fingertip Darts	26	Stun-Shocker	57
Floating Laboratory	26	Swarmbots	57
Force Cage	27	Thermo-Lance	58
Freeze Grenade	27	Time-Bot	58
Grabber	27	Time Displacer	59
Grappler Ray	28	Time Platform	59
Guardian Robot	28	Time-Shift Bomb	60
Gyroscopic Aircraft	29	Tractor Beam	61
Hawk Scanner	29	Vertigo Beam	61
Hologram Projector	30	Vibration Machine	62
Hyper-Sound Piano	30	Vibro-Bomb	62
Hypno-Persuader	30	Vortex Machine	63
Hypnopticon	35	Warrior Robot	63
Idento-Disc and Robot	36	XZ-12 Device	64
Image Projector	36		

# Preface & Introduction

## Preface

Welcome, Mighty Marvelites!

The book you hold in your hands has been tremendous fun for me to write. I've always enjoyed creating devices for the MARVEL SUPER HEROES game. Imagine my excitement when I was given the job of developing all of Doctor Doom's inventions!

After the initial elation wore off, I realized what a monumental undertaking this was going to be. After all, Doctor Doom has been around longer than I have! He has appeared in over 150 Marvel comics over the past thirty years and is almost always accompanied by new and devious inventions. How was I ever going to find all of those back issues? HELP!

Help soon arrived in the forms of Scott Davis, Steven Schend, and Tim Cummins. All three gentlemen supplied me with the numerous issues I couldn't locate. Tim, bless his soul, even trusted me with his entire FANTASTIC FOUR comic collection! Thanks, guys.

Credit must also be given to Jeff Grubb, the original designer of the MARVEL SUPER HEROES game. The first chunk of this book contains rules for creating and modifying inventions, rules which are much the same as those written by Jeff in the Advanced Rules set. I simply made some additions and clarifications which I think improved the technology system. I hope you (and Jeff) all agree.

After reading of Victor Von Doom's trials and tribulations, and writing statistics and rules for nearly 100 of his inventions, I've developed a kind of sympathy for him. He is the anti-hero, a man blind to his own megalomania, and a man who truly believes his twisted goals and thirst for power are good for the world. His masked face haunts my dreams.

What a great villain he is! Every super hero campaign should have a recurring antagonist like him. Doc Doom is a brilliant inventor, he dabbles in the mystic arts, and he rules an entire country. Being the first super villain with diplomatic immunity, Doctor Doom is a villain your player character heroes cannot arrest! What more could you ask for?

Anthony Herring

## Introduction

Within the dark mind of Victor Von Doom lie mysteries unfathomable. Through the armored despot's inventions, we watch the bright flames of true genius flickering behind his cold eyes.

This book contains over 90 of Dr. Doom's nefarious devices—from air cannons to the infamous (and long forgotten) XZ-12 device, you get them all. A brief description accompanies each item's entry, along with relevant game statistics and rules.

Although most of the devices are associated solely with Doctor Doom, Judges should feel free to use them throughout their campaigns. By changing the appearance and the name of an item, any of your high-tech villains can have variations of the equipment presented here.

As the Judge, feel free to tinker with the gadgets' various power ranks and abilities to suit the needs of your campaign. Doc Doom is always adjusting his equipment to neutralize specific super-powered foes. His antimatter extrapolator may bounce off the rocky hide of the Thing today, but just wait until next time, Mr. Grimm!

After being zapped, teleported, imprisoned, and flung into other dimensions by some of Doom's inventions, the players in virtually every campaign decide that it's time for their heroes to do a little inventing of their own. The first chapter of this book presents detailed rules for inventing and modifying high-tech equipment. The rules that follow should give you plenty of ideas on how to handle hardware construction and modification.

As a reminder, remember that the rules of the game are not written in stone. You, the Judge, have final say as to how the game is played. If you don't like some of the rules, change them. Just remember to be consistent, be fair, and above all else—have fun!





# Chapter 1: Inventing and Modifying Hardware

A vast array of technological wonders are presented in the pages of this book. Because most of these items lie within the steely grip of their creator—Victor Von Doom—player character heroes have a limited number of options if they want one of these inventions for their very own: They can try to "acquire" it from Doctor Doom—good luck!—or they can try to reproduce it themselves. This chapter presents rules for inventing high-tech gadgets and modifying existing ones.

It is important to note that high-tech characters are not affected by the following rules. These characters and their special gear can and should still be created according to the guidelines provided in the current MARVEL SUPER HEROES Basic Set.

## Tech Rank

The most important information required for building or modifying an item is its Tech rank, which measures how complex and powerful the invention is. Every device in this book has a Tech rank listed in its description. Like powers and abilities, Tech rank ranges from Shift 0 all the

way up to the infinite Beyond. Tech rank is equal to the highest applicable rank number of the device, taking into account certain modifiers. Applicable ranks are those ranks that define the performance of the object:

- *Vehicles:* Applicable ranks are Control, Speed, and Body (the overall material strength of the vehicle).
- *Weapons:* Applicable ranks are damage, range, and material strength.
- *Power Suits:* This classification includes all items that enhance a character's abilities. Applicable ranks are the modified abilities (Example: Good (10) to Amazing (50) Strength) and the material strength (or the equivalent Body Armor) of the suit.
- *Robots:* This includes androids, cyborgs, and all other types of artificial beings but not clones. Applicable ranks are the ranks of the being's listed abilities (Fighting, Agility, etc.) and any powers.
- *Miscellaneous:* With any other technological item that doesn't apply to the above classifications, its applicable ranks are its overall material strength and any power ranks involved.



Machines which duplicate abilities not readily available in our real world always have an applicable rank of Monstrous (75) added to everything else. If the heroes want to build a Good (10) rank time machine, a Monstrous (75) applicable rank is added since we do not have time machines in our society. A vehicle that flies with jet engines would not suffer this penalty, but one that flies due to antigravity devices would.

A device's applicable ranks that are realistically producible by 1990's technology have a Tech rank limit of Monstrous (75). For example, a conventional military jet has a Speed of Shift X(150), but since jet aircraft are common in our society, the rank is considered to be Monstrous (75) for determining the planes overall Tech rank. The jet still has a Speed of Shift X (150); it is only counted as Monstrous (75) for calculating Tech rank.

When the highest applicable rank has been determined, apply the following modifiers to that rank to find the invention's Tech rank:

- +2CS for every applicable rank equal to the highest applicable rank. For example, a battle suit with two Remarkable (30) powers would have a Tech rank of Amazing (50): Remarkable (30) +2 Column Shifts.
- +1CS for every applicable rank that is one rank lower than the highest applicable rank.
- +0CS for all ranks two or more ranks lower than the highest applicable rank.
- +2CS if the item is easily concealable and cannot normally be seen (Example: an ionic blade, a weapon hidden inside Doc Doom's armor).
- +1CS if the machine is portable.
- +1CS if the invention is pocket-sized or smaller.
- +1CS if it occupies more than one area; compartmented vehicles are considered to occupy as many areas as they have compartments.
- +1CS if the object is a robot designed to imitate a specific individual (such as a Doombot).
- -1CS if the item is a humanoid robot.
- -1CS if the item is a hand-held melee weapon which must touch the target to inflict damage, like a sword.

Once the object's final, modified Tech rank has been established, it's time to get down to the basics of creating the device. The following four factors are directly related to a device's Tech rank:

- The Resources required to build the item;
- The amount of time that must be spent building it;
- Whether or not the item actually works after design and construction; and
- Whether or not a character can use another character's invention.

## The Resource FEAT

Before work begins on inventing new technologies, the character must succeed at a Resource FEAT against the Intensity of the item's Tech rank. If the object has a Tech rank of Incredible (40), for instance, the character must succeed at an Incredible (40) Intensity Resource FEAT. This FEAT represents buying all of the various high-tech components needed to piece the invention together.

If the Tech rank is more than one rank higher than the character's Resource rank, it is an impossible FEAT for that character—he or she simply doesn't have the funds available. However, the FEAT can still be accomplished with outside help. Two characters can chip in to buy the materials. To do so, the Resource ranks of the characters involved must be within one rank of each other. If so, the higher rank is increased by +1CS.

Additionally, a character with insufficient funds, but with contacts in an organization, could persuade an outside corporation or benefactor to fund the project. Remember that contacts may have their own restrictions or requirements to any such agreement: "Well, now that you've completed your nuclear-powered battle suit, Joe Hero," says the smiling CEO of Tech-Star from behind a desk the size of Kansas, "we have a little job for you in Latveria. Surely you can help us after all the money we put in to your armor...."

If the Resource FEAT is failed, the character may make another attempt in one week (assuming it was not an impossible FEAT to begin with). It is rationalized that the inventor can actually afford to design and build the device, but does not have the money at hand.



### Special Requirements

Most powerful inventions need a certain component, substance, or ability to power them, called a special requirement. These components are totally in the province of the Judge, who should use them as a means to prevent heroes from building every type of gadget imaginable. For instance, if the characters can't come up with some antimatter, they won't be able to build a replica of Doom's antimatter extrapolator.

Special requirements also serve to place characters in adventure situations. An entire scenario could be designed around the hunt for a special item needed to restore power to a dying hero's life-saving environmental battle suit. For an example in the MARVEL UNIVERSE, the Fantastic Four traveled to the Negative Zone to get the Cosmic Control Rod to aid in the birth of Reed's son, Franklin Richards.

Special requirements also justify why villains commit crimes in order to finish their nefarious devices. In a recent adventure against Spider-Man, villains stole a priceless Latverian gem from a museum to further their ambitions. "This machine will call the holy Swarm back to Earth, to purify the planet of all but our kind!" gloated Master Andrew, leader of the Arcane Order of the Night, as he gently placed the powerful Dragon's Egg into a strange contraption aimed at the stars. "And tonight, at last, we have the occult engine with which to power the machine!"

In deciding whether or not a special requirement is needed, consider the function of the invention. If it duplicates a power that is not available in "real life" (such as time travel), a special requirement is always mandatory. Similarly, if the object has powers of Incredible (40) rank or higher, a special requirement should be called for, though items should rarely exceed three requirements. The Judge always has final say as to the number of special requirements (if any) needed, but he or she may be especially lenient in cases where speed is of the essence (as with kit-bashing).

When the Judge decides a special requirement is necessary, players should work with the Judge to create something that ties in with the device in question. Examples include:

- A special material or alloy is needed. For example, a noiseless engine might require vibranium, or a device of Unearthly (100) material strength may require some adamantium or uru metal.
- A specific component must be found for the device to function. For an electronic invention, a unique circuit board or computer chip may have to be acquired or developed independently at a Tech rank of -1CS from the original invention's Tech rank.
- Someone knowledgeable in the field must be consulted. Michael Morbius, Bruce Banner, and Doctor Octopus are all masters in the field of radiation, while Henry Pym and Bill Foster are two of the few consultants available on size control. Doctor Doom is a master in robotics, as well as just about every other field, including magic. Arranging a meeting with such experts is the hero's problem, and could certainly be the beginning of a memorable adventure.
- A unique process is needed to fire the reaction to complete the project. Some standard favorites are exposure to cosmic or gamma radiation, solar flares, zero gravity, and even sorcery. Tell the players what is required ("All you need to fully power your VTOL chariot is a charge of Unearthly Intensity lightning."), but let them figure out how to acquire it.
- A working model of the device must be found and studied. This can be required when trying to duplicate another's invention or a hero's powers. The cost of instruments to analyze the model may also be added, further increasing the difficulty in creating an item.



## Construction Time

The Tech rank number determines the number of days required to finish the project. For example, a flying rocket-powered skateboard with an Incredible (40) Tech rank takes 40 days to complete. This figure assumes normal working conditions: one man working alone with regular breaks for eating, sleeping, and other necessities. The following situations may reduce the construction time:

- If the inventor (the character making the Reason FEAT) has a lab assistant, the time is halved.
- If the assistant has a Reason within one rank of the inventor's, the time is quartered, rather than halved as described above.
- If the inventor works non-stop with only short breaks for food and rest, time is again halved.
- If the inventor has blueprints for the invention or a working model of a similar invention built by someone else, time is again halved.
- If the inventor has hired or persuaded a non-player character to do the work based on the inventor's requests or designs, the maximum amount of time is always used. A character may only work on one invention at a time, but he may have several projects being developed by others.

## The Reason FEAT

After succeeding at the Resource FEAT and spending the required amount of time completing the project, the inventor attempts a Reason FEAT roll to determine if all of his effort has paid off. The following modifiers are applied to the character's Reason:

- +1CS for an assistant with Reason no less than one rank lower than the inventor's (maximum of +1CS).
- +1CS for each applicable talent (electronics, robotics, etc.; maximum of +3CS total).
- +1CS if the device existed previously (the inventor's failed experiments, research on individual components, or salvaged parts from another device).
- +2CS if the inventor has another character's

blueprints or working model.

- -1CS if time was shortened by rushing the project.
- -1CS for each special requirement needed (maximum of -3CS).

Using his modified Reason, the inventor attempts a Reason FEAT against the Intensity of the item's Tech rank. If the Tech rank is Amazing (50), for example, an Amazing (50) Intensity Reason FEAT is called for. Karma may be added before the die roll, but in this case (and this case only!), the amount of Karma must be stated before the roll is made.

This is an impossible FEAT if the Tech rank is more than one rank higher than the inventor's modified Reason. After all of his effort, time, and money, the inventor still cannot fathom the intricacies of this machine. Back to the drawing board!

Even if the Tech rank is more than two ranks lower than the character's Reason, this is never an automatic FEAT. Everybody makes mistakes, even such brilliant scientists as Mister Fantastic and Doctor Doom.

If the Reason FEAT is failed, the device does not work and the inventor realizes he has missed a vital component—one special requirement is added. The character must start again, but no Resource FEAT is required (except possibly to get the new special requirement). Construction time is the same as before, and a Reason FEAT must again be attempted.

If the Reason FEAT is successful, the device works exactly as planned. Eureka!

## Kit-Bashing

Sometimes it is crucial for a hero to come up with a device right away if not sooner. The solution is to start kit-bashing—using what gadgets are immediately at hand to build something that will save the day. In the Marvel Universe, Reed Richards is the unparalleled champion at kit-bashing items to rescue the planet from peril.

Kit-bashing proceeds much like normal inventing, but no Resource FEAT is necessary, and construction takes far less time at the expense of Karma. Every 10 points of Karma spent reduce one day of normal work to one





round. For example, if a machine has a Tech rank of Amazing (50), it takes 50 days to build under normal circumstances. By spending 500 Karma points, the construction time is reduced to 50 rounds.

Kit-bashing may also be used to rush a project to completion. Your character is on the fifth day of work on a robot-neutralizer device which requires 10 days of construction time, but Doctor Doom's robot army suddenly attacks! The project can be completed in five turns by kit-bashing. However, if any part of the device is kit-bashed, the entire machine is considered to have been kit-bashed.

The inventor must still succeed at a Reason FEAT as described previously. If the roll is failed, the device does not function. Another attempt may be made, but the construction time is the same, and Karma must be spent again. Unlike standard hardware creation, a new special requirement is not added with a failure at kit-bashing.

If the Reason FEAT is passed, the device operates as planned for 1-10 rounds before becoming useless. Depending upon the gadget, it might explode, fuse solid, or simply fall to pieces. If the inventor can salvage the remains, he receives a +1CS bonus on future Reason FEAT rolls to duplicate the item.

Karma for kit-bashed devices can be taken from any source available to the inventor: his own fund; Karma pools he belongs to; Karma that has been set aside for advancement; and Karma contributed by assistants.

## Modifying Hardware

Sometimes heroes don't want to build an entirely new device, but simply want to modify an existing one. Modification is often less expensive than a full-scale project, and can be used to smooth out the edges of inventions or improve them slowly.

Only one modification can be made to a device at one time. Adding blaster weapons and a turbo-jet to your motorcycle is actually two separate modifications; one must be done before the other.

Modifications that alter abilities have a Tech rank equal to the new ability rank. Each ability may only be added one rank at a time. If a hero wants to increase the Body Armor rank of a battle suit from Good (10) to Remarkable

(30), he must first modify it to Excellent (20), then make a second modification to Remarkable (30).

Modifications that give abilities or powers which the device did not already possess (such as Flight for a battle suit) have a Tech rank equal to the power rank of the added feature. Remember that powers not reproducible by modern technology have a minimum Tech rank of Monstrous (75).

The Resource FEAT, construction time, and Reason FEAT of a modification are all handled exactly as for any standard invention. Failure during modification stages may damage the original device as well, with individual results determined by the Judge. Modifications can be kit-bashed.

## Damage

All devices have a material strength rank, which provides them the equivalent of Body Armor. For a vehicle, material strength equals its Body attribute. When any device suffers damage greater than its material strength, it immediately ceases to function; robots are an exception, as noted below. If it is a vehicle and is moving, it crashes. If the amount of damage inflicted is two times the item's material strength or greater, it is utterly destroyed, damaged beyond repair, kaput.

If the amount of damage caused is less than twice the device's material strength, it is damaged and does not work, but the item may still be repaired. Subtract its material strength from the damage done, and reduce its material strength by the remainder. For example, if a machine with Remarkable (30) material strength suffers an Incredible (40) attack, it ceases to function and now has a material strength of Excellent (20):  $40-30 = 10$ ;  $30-10 = 20$ .

A device that has not been totally obliterated may suffer damage in addition to a loss of material strength. Roll a FEAT against the item's lowered material strength:

- *White:* All of the device's applicable ranks are reduced by -2CS (except material strength, which has already been lowered).
- *Green:* All of the item's applicable ranks are reduced by -1CS (excluding material strength).

- *Yellow*: One of the machine's applicable ranks is reduced by -1CS (choose at random; excluding material strength).
- *Red*: None of the invention's applicable ranks is reduced (except material strength, of course).

If any of the device's applicable ranks are reduced to Shift 0, it is damaged beyond hope and cannot be repaired. The pieces may be salvaged for use in new inventions along similar lines.

## Damage to Robots

Unlike other devices, robots and their kin (androids, cyborgs, synthezoids, etc.) have Health points and suffer damage just like other characters. Player character robots and artificial beings (and some non-player character robots, as determined by the Judge) are assumed to have self-repairing circuitry and other regenerative systems that allow them to heal damage like normal humans and humanoids. This is a standard rule, though some characters are exceptions; Misty Knight's bionic arm does not have any regenerative capabilities, and must be externally repaired whenever it is damaged.

As an addition to the rules, assume that characters with the robotics skill can use that talent to administer first aid to a robot. This halts the Endurance loss of "dying" robots, including those at Shift 0 Health. Robots receiving this aid regain one rank of Endurance immediately (if any were lost).

## Long-Term Repairs

A repair center (usually part of the inventor's laboratory) is required to fix damaged machines, and can increase the healing rate of robots just as hospitals do for biological characters. The Tech rank of the repair center determines its Resource cost and its overall effectiveness. For example, a repair center of Good (10) Tech rank may be used to make repairs at up to Good (10) rank—an Excellent (20) or higher rank mechanism could not be fixed here.

Damaged machines are those that have lost applicable

ranks. If the Tech rank of the repair center is at least two ranks greater than the Tech rank of the device, full repairs are possible (assuming the controller successfully makes his Reason FEATs). Otherwise, a repair center can restore one rank at a time. A Green Reason FEAT is attempted for each rank, using the Reason of the repair person or the Tech rank of the center, whichever is less. Karma may be added to the roll of a PC or NPC repair person, not a repair center. The Reason FEAT is the same as for modifications, and must be attempted for each repaired rank. Time is measured in hours rather than days.

Repairs in the field may be made with a successful Reason FEAT against the Intensity of the original applicable rank. If a vehicle's Excellent (20) Speed has been reduced to Good (10), a character can make a temporary repair by succeeding at an Excellent (20) Intensity Reason FEAT roll. Repair time equals one turn per applicable rank number. The vehicle's Speed in the above example would take 20 turns to fix. Only one rank can be repaired per attempt—it is not possible to raise the vehicle's Speed from Typical (6) to Excellent (20) in one repair attempt.

Field repairs last for 1-10 hours before shaking loose again. As a result of the jury-rigging, more damage is caused to the machine—the applicable rank ends up at one rank lower than that before repairs were made. In the previous example, the vehicle's Speed after 1-10 hours would be reduced to Typical (6).

## Reprogramming

The construction of computers and robot non-player characters follows the same rules as for constructing other types of devices. Such machines are assigned Reason abilities, but possess no creative thought or personality of their own (player character robots and other synthetic heroes are the exception). The artificial Reason ability reflects the amount of stored information the device has and the ease with which it can access it. Computers are only as smart as the information they receive and accessing information or reprogramming a computer or robot is simple if the proper passwords are known. Passwords allow the user to bypass any internal





security programs. The level of security of a computer or robot is the same as its Reason.

If the passwords are not known, taking information from or reprogramming a computer or robot requires the character to succeed at a Reason FEAT against the Intensity of the machine's Reason. The time required to perform the procedure is equal to the machine's Reason rank number in turns.

With the proper passwords, the device's Reason is considered to be at -4CS for determining the Intensity of the required Reason FEAT. The time required to extract the information or reprogram the machine is also reduced by -4CS. The amount of time needed to reprogram a computer or robot cannot be reduced to less than two rounds (Feeble (2) Reason).

As an example, Reed Richards has captured a Doombot that was attacking Four Freedoms Plaza. It has Excellent (20) Reason, and Reed wants to reprogram it to attack its master. Because he doesn't know the robot's various passwords, Mr. Fantastic must succeed at an Excellent (20) Intensity Reason FEAT. With his Amazing (50) Reason and talents in robotics and electronics, this is hardly a problem for Mister Fantastic. The process takes him 20 turns to complete, and then the robot is sent on its way—watch out Victor!

### Using Another Inventor's Creations

To successfully use a device invented by someone else, the character must succeed at a Reason FEAT roll, using the item's Tech rank as the opposing Intensity. Failure indicates the character hit the wrong button, activated the wrong system, pointed it in the wrong direction, or caused some damage to the device. The Judge should vary results according to the situation.

A Reason FEAT need not be attempted each time the device is used. Once a character succeeds at the FEAT, it is assumed he or she has "got the hang of it," understands the basic function and workings of the device, and can use it without additional risk.

### Mixing Science and Sorcery

Doctor Doom's Reason is high and his scientific resources are phenomenal, but his talents in sorcery can sometimes lend a hand in his inventions. When applied correctly, inventors skilled in mystic arts can use magic to help them pass the Resource and Reason FEAT rolls involved in hardware building, drastically reducing the total construction time of the item.

To combine magic with inventing, the character must first succeed at a Yellow FEAT roll against his magical ability power rank. If the roll is missed, the inventor's magical abilities cannot help him with that particular item. If the roll is passed, construction time is shortened in relation to the inventor's magical power. Additionally, the device's Tech rank is considered to be lower when determining the Intensity of any Resource and Reason FEATs. Thus, through magic, it is possible for inventors to pass what would otherwise be impossible FEATs. How much the time and FEAT Intensity are reduced depends upon the inventor's magical ability power rank:

Magic Ability Rank	Reduction of Intensity	Reduction of Time
Feeble (2)	-1CS	-25%
Poor (4)	-1CS	-25%
Typical (6)	-1CS	-25%
Good (10)	-2CS	-25%
Excellent (20)	-2CS	-50%
Remarkable (30)	-2CS	-50%
Incredible (40)	-3CS	-50%
Amazing (50)	-3CS	-75%
Monstrous (75)	-3CS	-75%
Unearthly (100)	-4CS	-75%

For example, an inventor with Amazing magical ability could construct an Incredible (40) Tech rank item as if it were a Good (10) Tech rank (for Reason and Resource FEATs) and complete it in 10 days.

At Shift X (150) or greater magical ability, the character is such a powerful sorcerer that the thought of spending time to invent technological items is ridiculous. Such a character could probably create whatever he desired with no need of technology.

## Chapter 2: Doom's Technology Catalogue

This chapter presents nearly all of Doctor Doom's devious machines, including his various robots and famous armor. All items are presented in alphabetical order, for easy reference. Each entry begins with a brief description of the invention, and details are further broken down as follows:

**First Appearance:** The title and issue number of the Marvel comic book in which the item initially appeared are listed for those fans interested in seeing the item in action. In these titles, the following abbreviations may be used: "GS" = GIANT SIZE; "Vol." = Volume (if a title has been used for more than one series run).

**Statistics:** For robots and other characters, the seven primary attributes (Fighting, Agility, etc.) and their power ranks are provided. Note that Karma use is allowed by androids and advanced robots, not common robots. Vehicles are described by Control, Speed, and Body (material strength).

**Powers:** The item's various powers are described in regard to power rank, range, damage, and any special rules.

**Limitations:** If the device has any special weaknesses or limitations, that information is presented here. For example, the machine might not be able to affect robots or cybernetic organisms.

**Talents:** Robots and certain specialized inventions may have talents just like player characters.

**Role-Playing Notes:** This gives the Judge information on how to role-play an NPC robot or other synthetic character; just because it might be artificially created doesn't mean it doesn't have any character.

**Material Strength:** The object's material strength is given as a rank number. Material strength often acts as Body Armor is used to determine when, and how severely, an item is damaged.

**Tech Rank:** Robots and other devices are given a Tech rank, which measures how complex the object is to invent or reproduce. All information on Tech rank is detailed in Chapter 1 of this book.

**Availability:** In general, this section provides information on how many known models of each item exist, how many Doctor Doom owns, and where he keeps them.

### Categorical Listing

The names of some of the following inventions are uniquely cryptic, making it difficult to understand what a device does from its name alone. This can pose problems for Judges in the midst of game play. For example, Cindy is currently running a game session and needs to know what Doctor Doom might use to imprison a powerful foe. Flipping through the book and looking at all the entries that might possibly be a confinement device slows down play, and her game's pace and action starts to suffer.

To make things easier, all of the gadgets herein are listed under the following general categories:

Confinements  
Defenses  
Robots and other NPCs  
Vehicles  
Weapons  
Miscellaneous

When you need a vehicle, for instance, simply look down the list of vehicle names, pick one that sounds interesting, and look up its full description in the text. The main catalogue text contains all the items fully alphabetized, not separated by classifications.

One item of interest for those well versed in Doom's robots: many of his robots have been summarily deemed by outsiders as "Doombots" or "Guard robots" or other such generic terms. Within our comprehensive study and cataloguing of Dr. Doom's robots, we have used the terms that Doom himself gives the robot; some names were never given in their initial comic appearances, but their names were verified through Marvel Comics (and the Latverian Embassy). Any other name references to the contrary of what has been collected here goes contrary to the wishes of Doom—something we should all painstakingly wish to avoid.

Make good use of the secret and powerful technologies within these pages. The secrets of Doom have always been closely guarded until now.. ..





### **Confinements**

- Aquarium Cage
- Electronic Shackle
- Force Cage
- Molecular Cage
- Neuro-Chamber
- Plasteel Sphere
- Power Dampener

### **Defenses**

- Armor, Doom's Original
- Armor, Doom's Promethium
- Inhibitor Ray
- Insulato-Shield
- Neuro-Space Field
- Plasti-Gun
- Power Sphere
- Psionic Refractor
- Tractor Beam
- Vibration Machine

### **Robots and other NPCs**

- Doombot, Combat
- Doombot, Diplomatic
- Doom-Knight
- Doomsman I
- Doomsman II
- Doom Squad
- Guardian Robot
- Invincible Robot
- Latverian Soldiers
- Micro-Sentry
- Pacifier Robot
- Robotron
- Seeker
- Silent Stalker
- Swarmbots
- Time-Bot
- Warrior Robots

### **Vehicles**

- Amphibious Skycraft
- Bubble Ship
- Excavator
- Floating Laboratory
- Gyroscopic Aircraft
- Saucer-Ship

### **Weapons**

- Air Cannon
- Antimatter Extrapolator

- Concussion Ray
- Cosmic-Beam Gun
- Electro-Shock Pistol
- Energy Fist
- Fingertip Darts
- Freeze Grenade
- Hyper-Sound Piano
- Instant Hypnotism Impulser
- Intensified Molecule Projector
- Ionic Blade
- Metabolic Transmuter
- Mini-Missile Launcher
- Molecule Displacer
- Nerve Impulse Scrambler
- Omni-Missile
- Rainbow Missile
- Refrigeration Unit
- Ring Imperial
- Stasis Gun
- Stun-Shock
- Thermo-Lance
- Time-Shift Bomb
- Vertigo Beam
- Vibro-Bomb
- Vortex Machine

### **Miscellaneous**

- Bio-Enhancer
- Body-Transferral Ray
- Enlarger Ray
- Grabber
- Grappler Ray
- Hawk Scanner
- Hologram Projector
- Hypno-Persuader
- Hypnopticon
- Idento-Disc and Robot
- Image Projector
- Memory Transference Machine
- Multi-Dimensional Transference Center
- Particle Projector
- Power Transference Machine
- Psycho-Prism
- Reducing Ray
- Sonic Drill
- Spider-Finder
- Spider-Wave Transmitter
- Time Displacer
- Time Machine
- XZ-12 Device

## Alphabetical Listing

### Air Cannon

This cumbersome weapon is a common sight atop the walls of Castle Doom. Three warrior robots are required to operate the huge gun. It is highly effective against aerial attackers, and was specifically designed to defeat the Human Torch, the cannon easily able to snuff the flame of the young hero.

**First Appearance:** FANTASTIC FOUR #87.

#### Powers:

*Air Blast:* Once per round, the cannon can fire a jet of intensified wind of Amazing (50) rank force. Check attack results on the Force Column of the Battle Effects Table. The weapon has a range of 10 areas. If the Human Torch (or a character with similar powers) is hit by the air jet, he must succeed at a Power FEAT or lose the ability to "flame on" for 1-10 turns in addition to any standard battle effects such as Stun or Slam.

**Material Strength:** Excellent (20).

**Tech Rank:** Amazing (50).

**Availability:** During times of trouble, at least one of these weapons is raised atop the outer wall of Castle Doom by means of a hydraulic lift. Placed on a mobile platform, the cannon can roll along the top of the wall to fire in any direction.

### Amphibious Skycraft

This vessel looks much like a small, multi-finned rocket and is built for both aerial and submersible modes of travel. It is not equipped with weapons, the vehicle meant only for transportation. The skycraft has three cabins, the aft cabin containing the engines, the central cabin equipped with enough space to seat ten passengers, and the pilots' cabin up front.

**First Appearance:** SUPER-VILLAIN TEAM-UP #2.

#### Statistics:

Control: EXCELLENT (20)  
Air Speed: Shift X (150)  
Water Speed: REMARKABLE (30)  
Body: EXCELLENT (20)

#### Powers:

*Compartmentalization:* The vessel is divided into three air- and watertight compartments—forward, midships, and aft. Each section has Excellent Body. Only when Body is reduced to 0 in each compartment does the ship begin to sink underwater; while in flight, ruptured sections depressurize and contents are sucked outside. For each section breached, control and speed are reduced by -1CS.

*Flight:* Powered by a single rocket engine, the skycraft flies through the air at Shift X (150) air speed (50 areas per turn/750 miles per hour).

*Remote Control:* The skycraft can be programmed to move in a pre-set flight path. Its functions can also be controlled by a hand-held remote control device at up to Monstrous (75) range (approximately one mile) away from the vessel.

*Submersible Capability:* The craft can be "flown" underwater at Remarkable (30) speed (6 areas per turn/90 miles per hour).

*Teleportation Device:* The skycraft is equipped with a teleportation device which can be pre-set to return teleported individuals to the ship at a specified time. The teleporter has Amazing (50) range (up to 20 areas away), and it can teleport up to three individuals at the same time to the craft.

**Material Strength:** Excellent (20).

**Tech Rank:** Shift Y (200) (ship); Unearthly (100) (teleporter).

**Availability:** Doctor Doom owns the one working model of this ship, and it is kept in a hangar beneath the courtyard of Castle Doom, concealed by a sliding section of cobblestone pavement.





## Antimatter Extrapolator

Developed sometime prior to Doom's second reclamation of Latveria's throne, this pistol looks much like the standard handgun Dr. Doom typically carries in his belt holster. However, it is far more deadly than any typical handgun and certainly one of the most powerful weapons in the Latverian monarch's arsenal. As Dr. Doom stated while recently battling the Thing, "An antimatter extrapolator, Grimm! It will put a dent even in your thick hide!"

**First Appearance:** FANTASTIC FOUR #350.

### Powers:

*Antimatter Blast:* The weapon fires a tight beam of antimatter particles up to a range of 1 area. When solid matter and the antimatter beam meet, the result is an explosion, as a minute amount of physical matter is instantly transformed into energy. Resolve attacks on the Force Column. If the target is struck, he suffers Unearthly (100) force damage, as the meeting of his very atoms with the antimatter particles triggers an explosion; even though this is considered a force attack, the blast itself is considered an energy attack against a target's Body Armor. In addition, the force of the explosion can cause Slams or Stuns (Yellow or Red results, respectively) like a blunt attack.

This weapon can also affect individual items of inorganic matter, such as doors, walls, and so forth. The pistol can be fired once per round, and has enough ammunition charges for 10 shots.

**Material Strength:** Excellent (20).

**Tech Rank:** Shift Y (200).

**Availability:** Although the original was destroyed by the Thing, it is likely that Doctor Doom has at least one other functional antimatter extrapolator (or at least the blueprints for its construction) at his disposal.

## Aquarium Cage

This bizarre prison was designed especially for the Human Torch. It consists of a large glass and steel tank, a steel reservoir and pump filled with inert fluid connected to the tank, and a separate control panel. When a captive is placed inside and buttons on the panel pressed, fluid spews from the canister and floods the tank, neutralizing any fire-using heroes (or villains).

**First Appearance:** FANTASTIC FOUR #288.

### Powers:

*Inert Fluid:* The free-oxygen concentrated liquid in the tank can be breathed like air. However, its fluid properties inhibit open flames or other forms of external combustion. Thus, it does not allow the Human Torch to "flame on."

Physically breaking out of the bullet-proof glass walls of the aquarium requires a successful Excellent (20) Intensity Strength FEAT. The control panel can be used to drain the tank of fluid and open the door.

**Material Strength:** Excellent (20) (glass walls); Good (10) (control panel).

**Tech Rank:** Remarkable (30) (tank and control panel); Monstrous (75) (inert fluid).

## Armor, Dr. Doom's Original

Doctor Doom's iron-clad face is instantly recognizable to most of the world's population, a fact attributable to his famous high tech, nuclear powered, computer assisted battle suit. Doom's first (and truly "original") set of armor was magically forged at a hidden monastery in the high mountains of Tibet; since then, his dark plated armor has been enhanced and repaired by normal technological means. Although a skilled practitioner of the mystic arts, Victor Von Doom more often relies upon his armor for most of his powers.

**First Appearance:** FANTASTIC FOUR #5 (1st recorded appearance); FANTASTIC FOUR ANNUAL #2 (1st chronological appearance).

**Powers:** The following powers are standard features of the armor—Doom always has these abilities in his armor without exception.

**Body Armor:** The armor is fashioned of a high-strength titanium-alloy of Incredible (40) material strength. It provides Doom with Incredible (40) protection versus physical and energy attacks.

**Communicator:** Built into the right wrist of his armor is a video communicator which can put him in visual contact with technicians at any of his strongholds. The device has a Class 3000 transmitting and receiving range of 10,000 miles. For purposes of building the communicator in the game, its Tech rank is considered Uearthly (100).

**Electrical Field:** To deal with those insignificant fools who would dare to touch Doom, his armor is built to generate an Uearthly (100) Intensity electric shock on command. The shock is so powerful that all characters in the same area as Doom, but not in direct contact with him, suffer an Incredible (40) jolt of energy damage as well. In addition to damage, victims must succeed at either an Uearthly (100) or an Incredible (40) Intensity Endurance FEAT or fall unconscious for 1-10 rounds.

**Flight:** The armor is equipped with twin jetpacks mounted at the waist, enabling the armored monarch to fly at an Excellent (20) air speed (10 areas per turn). Some older suits of armor contain a back-mounted single jetpack which operates at the same speeds.

**Force Bolts:** Doom can fire bolts of concussive force from the gauntlets and faceplate of his armor, inflicting up to Monstrous (75) force damage. The effective range of these force blasts is 10 areas, though their maximum range is 40 areas (-1 CS for every 10 areas beyond effective range). Check attack results on the Force Column of the Battle Effects Table. Note that Doom's mask only generates force blasts when it is not being worn.

**Force Field:** Doom's best defense is the Monstrous (75) force field generated by his armor. With a maximum radius of eight feet, the force field surrounds Doom (and possibly others) and protects him from both physical and energy attacks. However, Doom cannot attack without lowering this force field.







**Infrared Scanners:** This feature of the helmet allows the wearer to detect heat sources at Remarkable (30) rank range and effectiveness, enabling him to see invisible persons of Remarkable or lower rank power.

**Life Support:** Equipped with internal stores and recycling systems for air, food, water, and energy, Doom's armor is self-supporting, allowing it and him to survive lengthy periods of exposure (several weeks) underwater or in outer space at Incredible (40) rank.

**Optical Scanner:** This Monstrous (75) rank function allows the helmet's eyepieces to be used as high-powered telescopes. The wearer can clearly focus on distant targets up to a range of 40 areas, but does not allow bonuses for targeting purposes.

**Parabolic Ear Amplifiers:** These mechanisms are fitted inside the helmet, and allow Doom to detect extremely faint sounds (a whisper across a crowded room, for example) and unusual frequencies within the audible range for humans. The amplifiers function at Remarkable (30) rank range (8 areas).

**Remote Control:** The armor automatically responds to Doom's movements and conscious mental commands. If he is separated from the armor or unable to physically control it, it can respond to either preprogrammed instructions or his remote control at Monstrous (75) rank ability and range (40 areas). The armor, whether Doom occupies it or not, can only be deactivated by attacks of Amazing (50) rank or greater (Shift X (150) attacks if the Force Field is activated).

**Thermo-Energizer:** This feature of the armor allows it to absorb and store solar and heat energy of up to Amazing (50) Intensity, and use that energy to power the armor's other systems. This system can only be used while the Force Field is deactivated, and can only store and use 50 points of energy per round.

**Optional Powers:** The following powers are additional weapons and weapon systems which Doom does not normally carry, but which can be added to his armor whenever it is needed. Generally, if Doctor Doom believes that an item might be useful for an upcoming "engagement" (and he is usually correct), he has the appropriate additional systems fitted into his armor. In any event, it is unlikely that Doom's ego would allow

him to use more than one or two of these "add-ons" for any given task. "What need have I of such trinkets? The mind of Von Doom is the most lethal weapon of all!"

For specific details about the following equipment, see their individual listings in this section of the book:

*Energy Fist*  
*Fingertip Darts*  
*Image Projector*  
*Inhibitor Ray*  
*Instant Hypnotism Impulser*  
*Intensified Molecule Projector*  
*Ionic Blade*  
*Mini-Missile Launcher*  
*Nerve Impulse Scrambler*  
*Neuro-Space Field*  
*Refrigeration Unit*  
*Sonic Drill*  
*Stun-Shocker*

**Material Strength:** Incredible (40).

**Tech Rank:** Class 5000. Not only is the armor highly advanced in terms of modern technology, but the construction of it is one of the best kept secrets in the world. Duplicating Doom's armor (by anyone but himself) is virtually impossible by any single inventor; the only denizens of the MARVEL UNIVERSE who might possibly duplicate the armor would be Reed Richards (once he gained a Talent for Occult Lore) working in tandem with Dr. Stephen Strange (after he learned Engineering).

**Availability:** Doctor Doom is seldom (if ever) seen without his armor. Spare parts and prototype armor can be found in his personal workshops within his castles. It is unlikely that he keeps fully functional spare suits available. None of his underlings know more than the basics of his armor's power systems and a scarce few know how to repair isolated weapon systems—only Doom knows all the secrets of his armor, and he intends to keep it that way!

## Armor, Doom's Promethium

Despite Doom's formidable power, he is always in search of greater might—and he found it in a mystical metal known as Promethium. Used years ago in his experiments to create Darkoth, Doom recently found that the metal is also an inexhaustible source of energy. Unfortunately, it is only found in a dimension called Otherplace, formerly known as Belasco's and Magik's Limbo.

As Doctor Doom experienced firsthand, "he who wields the Soulsword is ensconced in promethium armor." The armor conjured by the Soulsword is shaped by the wielder; the armor had been worn by both Magik and Shadowcat (of New Mutants and Excalibur fame). Aside from looking like lustrous steel, Doctor Doom's promethium armor looked similar to his normal armor.

**First Appearance:** FANTASTIC FOUR #350 (1st recorded appearance); EXCALIBUR #39 (1st chronological appearance).

**Powers:** Doom's promethium armor granted him all of the abilities associated with his normal armor due to a mystical merging of the two types of armor.

Additionally, Doom (as well as anyone else who wears the armor) gains the following powers:

*Body Armor:* Promethium armor grants Amazing (50) protection versus physical and energy attacks.

*Enhanced Abilities:* The armor raises the wearer's physical attributes (Fighting, Agility, Strength and Endurance) by +2CS to a maximum rank of Unearthly (100). The character's Health is also increased while the armor is worn.

**Material Strength:** Amazing (50).

**Tech Rank:** Promethium armor is a mystical effect of the Soulsword, and cannot be reproduced by technology.

**Availability:** Only the wielder of the Soulsword can wear the armor; Doom temporarily maintained his promethium armor in our reality due to time variances between Otherplace and Earth but lost this armor to the sword's current wielder, Darkoth.

## Bio-Enhancer

Doom's bio-enhancer is a healing device, one of his few pieces of technology not geared toward world domination and destruction. It consists of a table surrounded by the subject and computer consoles. Energy is showered upon the subject and the table, artificially stimulating a body's natural healing processes to its ultimate extent. Simply put, this machine boosts metabolic rates and cell reproduction to effect faster healing.

**First Appearance:** FANTASTIC FOUR VS. X-MEN #3.

### **Powers:**

*Healing/Regeneration:* The bio-enhancer restores lost Health and Endurance ranks to injured characters at an Amazing (50) rank. While exposed to the bio-enhancer, up to 50 Health points and one Endurance rank can be restored to a character in a single day. The machine heals virtually all types of damage (blunt, edged, shooting, energy, etc.), except damage from diseases or poisons.

**Material Strength:** Good (10).

**Tech Rank:** Unearthly (100).

**Availability:** The only known model of Doom's bio-enhancer is located within Castle Doom.

## Body-Transferral Ray

Doctor Doom built this machine to switch bodies with Daredevil, allowing him to attack the Fantastic Four by surprise in a friend's body. Subjects of the device stand within glass cylinders that are connected to computers and other machinery. Spiraling waves of energy surround the subjects, and they each suddenly find that their minds have switched bodies.

**First Appearance:** DAREDEVIL #37.



**Powers:**

*Body Transferral:* Subjects of this device switch their minds and memories to the opposing body along with mental abilities, talents, and mental powers. Physical powers and abilities are not transferred, nor are Popularity, Resources, or Contacts—these remain the same for each body.

If either subject does not want the process to occur, he can resist transferral by succeeding at a Remarkable (30) Intensity Psyche FEAT roll. Of course, transfer can be attempted each round as long as both subjects remain in the glass cylinders. Once the transferral is complete, it is permanent. However, the machine can be used to reverse the effect.

**Material Strength:** Excellent (20) (cylinders), Typical (6) (machinery).

**Tech Rank:** Monstrous (75).

**Availability:** Doctor Doom built one of these machines within the Latverian Embassy in New York City. It was destroyed, however, by Daredevil. It is unknown whether any working models or blueprints still exist.

## Bubble Ship

The hull of this spherical vessel is made of semi-transparent plasteel. It measures 10' in diameter. The only feature on its round, smooth surface is the royal seal of Latveria.

Through Doom's genius, the bubble ship travels extremely fast under the sea. As the Sub-Mariner marveled, "Doom's craft turns the tremendous pressure of the very water about it to a propellant force! Travelling far swifter than any Atlantean or surface vessel!"

**First Appearance:** SUPER-VILLAIN TEAM-UP #13.

**Statistics:**

Control:	EXCELLENT (20)
Water Speed:	AMAZING (50)
Body:	INCREDIBLE (40)

**Powers:**

*Submersible:* The bubble ship can travel underwater at Amazing (50) speed (8 areas per turn).

**Material Strength:** Incredible (40).

**Tech Rank:** Unearthly (100).

**Availability:** Doctor Doom owns one bubble ship, which is kept in dry dock far beneath Castle Doom.

## Concussion Ray

This device consists of a small hand-held device containing complex computer circuitry. When activated, the concussion ray renders all unshielded targets within its area of effect unconscious by means of a painful, invisible force blast.

**First Appearance:** FANTASTIC FOUR #288.

**Powers:**

*Concussion Ray:* All characters within the same area as the concussion ray must attempt an Incredible (40) Intensity Endurance FEAT roll; the wielder of the ray is shielded from harm by the device. Those who fail fall unconscious for 1-10 rounds. Those who succeed may act, but all FEATs are at -3CS due to intense pain. The pain persists until the device is shut off. This ray can operate for 10 rounds of continuous use.

**Material Strength:** Excellent (20).

**Tech Rank:** Unearthly (100).

**Availability:** Doctor Doom has one working model of this weapon within his hidden laboratory beneath the Latverian Embassy in New York City.

## Cosmic-Beam Gun

This futuristic handgun fires a small beam of cosmic radiation. Invented by Doctor Doom to be used against the Thing, the cosmic energy changes the Thing into his human form as Ben Grimm, who gained his powers as a result of exposure to cosmic rays.

**First Appearance:** FANTASTIC FOUR #23.

### Powers:

*Cosmic Blast:* The weapon emits a thin beam of Remarkable (30) Intensity cosmic energy up to a range of 8 areas. In addition to causing Remarkable (30) energy damage, the ray has a specialized effect on the Thing. It causes him to revert to his human form for 1-10 turns if he fails a Remarkable (30) Intensity Endurance FEAT roll.

Although the other members of the Fantastic Four also received their powers from cosmic rays, this gun does not remove their powers as it does with the Thing. If another Fantastic Four member is hit with the cosmic blast, his or her powers are merely reduced by -2CS for 1-10 turns (if the character fails a Remarkable (30) Intensity Endurance FEAT).

**Material Strength:** Good (10).

**Tech Rank:** Unearthly (100).

**Availability:** This weapon was built by Doom when he first began battling the Fantastic Four. At that time, the Thing was less powerful than he is today. If Doom were planning to use this weapon, he would need to increase its power (minimum rank of Amazing (50)) to counter the current enhanced abilities of the Thing.

## Doombot

Doombots are exact mechanical replicas of the real Doctor Doom. They look like him, talk like him, and even act like him. Individually, Doombots have an advanced artificial intelligence program that causes them to believe themselves to really be Doctor Doom, and act as Doom unless in the presence of the real Von Doom or other Doombots. These imitation Dooms have been created to impersonate Doctor Doom when he either cannot be present or is unwilling to risk his own life (such as when confronting powerful foes).

There are two specific models of Doombots actively used by Victor Von Doom for various purposes: combat and diplomatic Doombots. Both models have the same essential intelligence programs and operating systems, but they have their differences within secondary systems.

**Limitations:** In order to prevent his duplicates from harming or out-performing him, Doctor Doom installs each Doombot with a dampener program that reduces all of its power ranks by -2CS when activated. This program is triggered whenever a Doombot enters the Master's presence or the presence of other Doombots. As further protection against his creations, Doom can cause any Doombot to self-destruct when it is in danger of capture, defeat, or simply becomes unimportant to him; this can be preprogrammed or activated by remote control. An exploding Doombot inflicts Incredible (40) energy damage to everyone in the same area as itself.

**Talents:** Doombots can operate all of Doctor Doom's inventions and exhibit Leadership to Latverians.

**Role-Playing Notes:** When impersonating their master, Doombots act so much like Victor Von Doom that technological equipment and some surface mental scans cannot tell the difference. When two or more Doombots meet, or when they confront the real Doom, their dampener programs activate, and they begin speaking in the monotone voices of intelligent robots: Doctor Doom's personality is replaced by emotionless programming.





## Combat Doombot

When Doctor Doom is out to defeat an enemy, he often sends a combat Doombot. They act so much like the real Doom, it is often impossible for a hero to determine if he is battling the real thing or merely a robot duplicate. Combat Doombots are more heavily laden with weaponry and sometimes carry an additional weapon system in addition to the standard armor's capabilities (see "Armor, Doom's Original" for details).

**First Appearance:** Unknown—any or nearly all of Doom's appearances could be attributed to a Doombot. The first substantiated appearance of a Doombot (an appearance stated or proven to be a robot) was in *FANTASTIC FOUR #5*.

### Statistics:

Fighting:	REMARKABLE (30)
Agility:	EXCELLENT (20)
Strength:	REMARKABLE (30)
Endurance:	INCREDIBLE (40)
Reason:	EXCELLENT (20)
Intuition:	EXCELLENT (20)
Psyche:	EXCELLENT (20)
Health:	120
Karma:	60

**Powers:** All combat Doombots have the following powers as standard equipment. They may also be fitted with any of the "add-on" features listed under the description of Doctor Doom's original armor.

**Body Armor:** Combat Doombots are constructed of Incredible (40) strength materials, and thus have Incredible (40) body armor.

**Electricity:** Each combat Doombot is wired to generate an Unearthly (100) Intensity electric shock on command, a very effective tactic against grappling opponents. The shock is so powerful that characters in the same area as the robot, but not in direct contact with it, suffer an Incredible (40) jolt as well. In addition to damage, victims must succeed at an Unearthly (100) or Incredible (40) Intensity Endurance FEAT or fall unconscious for 1-10 rounds.

**Flight:** Doombots have jet-packs, enabling them to fly at Excellent (20) airspeed (10 areas per turn).

**Force Bolts:** Combat Doombots can fire force bolts from their gauntlets, inflicting up to Amazing (50) damage.

**Force Field:** Each robot can generate a Monstrous (75) rank force field. With a maximum radius of eight feet, the force field surrounds the Doombot and possibly others. A Doombot cannot attack without first lowering its force field.

**Infrared Scanner:** This feature allows Doombots to detect heat sources at Remarkable (30) rank, enabling them to see invisible persons.

**Parabolic Ear-Amplifiers:** These enable Doombots to detect unusual frequencies and extremely faint sounds (a whisper across a crowded room, for example). The amplifiers function at Remarkable (30) rank and range (8 areas).

**Robotic Form:** Doombots are immune to mental, emotional, or illusory powers. They can be harmed by powers that affect machinery, however.

**Self-Assembly:** Inside the head of each combat Doombot are tiny mechanical arms and tools which enable the robot's head to completely assemble the rest of its body. This feature is used to infiltrate enemy strongholds—the pieces are sent in separately through a small opening (like a ventilation shaft), then the head puts them all together in a matter of minutes (Assembly program of Excellent Reason).

**Material Strength:** Incredible (40).

**Tech Rank:** Shift Y (200).

**Availability:** Though exact numbers are currently unknown and impossible to calculate, it is safe to assume that Doctor Doom has, at any given time, a small army of 50 combat Doombots built and ready to be activated by a signal.

## Diplomatic Doombot

When Doctor Doom plans to negotiate with others, rather than do battle, he often sends a diplomatic Doombot. They act as the real Doom, and it is often impossible for a character to detect the robot's presence. These Doombots benefit a more detailed intelligence program than the combat units, allowing more detailed talents and easier adjustment to random happenings.

**First Appearance:** Unknown—any or nearly all of Doom's appearances could be attributed to a Doombot. The first substantiated appearance of a Doombot (an appearance stated or proven to be a robot) was in FANTASTIC FOUR #5.

### Statistics:

Fighting:	EXCELLENT (20)
Agility:	EXCELLENT (20)
Strength:	EXCELLENT (20)
Endurance:	EXCELLENT (20)
Reason:	EXCELLENT (20)
Intuition:	REMARKABLE (30)
Psyche:	REMARKABLE (30)
Health:	80
Karma:	80

**Powers:** All diplomatic Doombots have the following powers as standard equipment. They may also be fitted with any of the "add-on" features listed under the description of Doctor Doom's original armor.

*Body Armor:* Diplomatic Doombots are made of Remarkable strength material and only have Remarkable (30) body armor.

*Flight:* Doombots have twin jet-packs, enabling them to fly at Excellent (20) air speed (10 areas per turn).

*Force Bolts:* Diplomatic Doombots can fire Remarkable (30) rank force bolts from their gauntlets and chest plates. Range is limited to 8 areas.

*Robotic Form:* Doombots are immune to mental, emotional, or illusory powers. They can be harmed by powers that affect machinery.

**Material Strength:** Remarkable (30).

**Tech Rank:** Shift X (150).

**Availability:** Total numbers are currently unknown, but it is safe to assume Doctor Doom has at least 10 diplomatic Doombots under his command at all times.

## Doom-Knight

These robotic guards stand a silent vigil atop the uppermost parapets of Castle Doom. Wearing gray plate mail and holding gray spears, Doom-Knights appear to be statues. In reality, they are high-tech warriors.

**First Appearance:** FANTASTIC FOUR VS. X-MEN #3.

### Statistics:

Fighting:	EXCELLENT (20)
Agility:	EXCELLENT (20)
Strength:	EXCELLENT (20)
Endurance:	REMARKABLE (30)
Reason:	GOOD (10)
Intuition:	POOR (4)
Psyche:	POOR (4)
Health:	90
Karma:	N/A

### Powers:

*Body Armor:* Doom-Knights are made of Excellent (20) strength materials, and have Excellent (20) protection against physical and energy attacks.

*Computer Link:* The robots are in direct communication with Castle Doom's various security systems and the Latverian border systems. When an alarm is raised, Doom-Knights may be ordered to respond, depending upon the situation. Range of the link is 5 miles.

*Force Spear:* Each Doom-Knight carries a spear capable of discharging a Remarkable (30) Intensity force blast up to a range of 8 areas.

*Glider-wings:* Folded behind its back, each Doom-Knight is equipped with a pair of wings which allow it to glide at Typical (6) airspeed (6 areas per turn).

*Robotic Form:* Doom-Knights are unaffected by mental or emotional attacks or illusions. They can be harmed by powers that affect machinery.





**Talents:** None.

**Role-Playing Notes:** The Doom-Knights are quiet sentinels without discernible personalities of their own. Unless activated, they stand as still as statues. Their only motivation is to obey their programming, which is to guard Castle Doom against intruders.

**Material Strength:** Excellent (20).

**Tech Rank:** Monstrous (75).

**Availability:** Doctor Doom has a standard force of ten Doom-Knights, which stand upon the upper ramparts of his castle.

## Doomsman I

This android has blue skin, but otherwise looks like a muscular, bald, human male. Doctor Doom created it as the first of an android army, but he soon found that the Doomsman had a mind of his own.

**First Appearance:** SUPER-VILLAIN TEAM-UP GS #2

### Statistics:

Fighting:	REMARKABLE (30)
Agility:	REMARKABLE (30)
Strength:	AMAZING (50)
Endurance:	MONSTROUS (75)
Reason:	EXCELLENT (20)
Intuition:	REMARKABLE (30)
Psyche:	EXCELLENT (20)
Health:	185
Karma:	70
Resources:	0
Popularity:	0

### Powers:

*Body Armor:* The android's blue skin provides Incredible (40) protection from physical and energy attacks.

*Dimensional Travel:* The Doomsman I can travel the dimensions at Remarkable (30) rank.

*Invisibility:* With this Excellent (20) rank power, the android can make himself invisible to normal sight.

*Resistance to Electricity:* The Doomsman has Amazing (50) protection from electrical attacks.

*Android (Robotic) Form:* The Doomsman I cannot be affected by mental, emotional or illusory attacks. It can be harmed by powers that affect machinery.

**Limitation:** Because the Doomsman I has the same brain wave patterns as Doctor Doom, Doom can take control of the android by a process called "mind fusion." To be successful, Doom must succeed at a Yellow Psyche FEAT roll, and must be within 20 areas of the android. Mind fusion lasts for as long as Doom devotes concentration to it, and remains within 20 areas of the Doomsman.

**Talents:** Leadership (to other androids).

**Role-Playing Notes:** The Doomsman I developed a will of its own, and quickly refused to obey Doctor Doom. It recognizes Doom as the only person who threatens its freedom, and is determined to kill its former master. Unlike the copying of Wonder Man's brain patterns wholesale into the Vision, Doom only patterned the Doomsman's electronic brain after his for purposes of control, not intelligence or personality.

**Material Strength:** Incredible (40).

**Tech Rank:** Class 1000.

**Availability:** Doctor Doom built several Doomsman I androids, but he only activated one of them when he realized it could not be controlled. It was banished to an alternate dimension by Doom, but it later developed a means to escape and returned, seeking revenge. It took the name Andro, Lord of Androids, and turned Doom's other androids against him. In the end, Doomsman I escaped by using his dimensional powers, and is presumably still plotting revenge. The status of the other models is unknown.

## Doomsman II

The Doomsman II was created by Doom to be the ultimate killing machine. It looks like a golden-skinned giant standing nearly 14' tall. The android was powered by the Power Cosmic, which Doom stole from the Silver Surfer.

**First Appearance:** FANTASTIC FOUR #157.

### Statistics:

Fighting: INCREDIBLE (40)  
Agility: EXCELLENT (20)  
Strength: Shift X (150)  
Endurance: UNEARTHLY (100)  
Reason: GOOD (10)  
Intuition: GOOD (10)  
Psyche: EXCELLENT (20)  
Health: 310  
Karma: 40

### Powers:

*Body Armor:* The Doomsman II's golden skin affords him Monstrous (75) protection from both physical and energy attacks.

*Growth:* Standing nearly 14' tall, the android has a permanent Good (10) rank growth power. As a result of his great size, he is +1CS to be hit.

*Power Cosmic:* The Doomsman II received its power from energy stolen from the Silver Surfer. Consequently, the android can channel and manipulate vast amounts of cosmic energy. His range with this power is line-of-sight, and he has used the Power Cosmic in the following ways:

- Power blasts from his eyes of Unearthly (100) energy or force (effect stated before rolls).
- Enhancement of any single ability score to Unearthly (100) for 1-10 turns.
- Survival with no need of food, water, or air.
- Energy detection of any type with Unearthly (100) ability (range covering the entire planet).

*Robotic Form:* The Doomsman II cannot be affected by mental or emotional attacks or illusions. It can, however, be harmed by powers that affect machinery.

**Talents:** None revealed.

**Role-Playing Notes:** The Doomsman II has no will of its own, but obeys the orders of its master—Doctor Doom. In combat, the android delights in its power, and has no inhibitions about killing.

**Material Strength:** Monstrous (75).

**Tech Rank:** Class 3000 (android); Unearthly (100) (device to instill it with the Power Cosmic).

**Availability:** Doctor Doom built one Doomsman II android that was defeated by the Fantastic Four and the Silver Surfer. Apparently, the android's cosmic energy dissipated, and Doom has never reanimated it. The dormant Doomsman II lies in the lower levels of Castle Doom, waiting to be revived to do its Master's bidding once again.

## Doom Squad

The Doom Squad consisted of four of Doctor Doom's best human soldiers. They were fitted with powerful battle suits designed to defeat the Fantastic Four. Ironically, the suits were never tested against the quartet, but the squad was defeated when the X-Men invaded Doom's castle in the Adirondack Mountains of upper-state New York.

**First Appearance:** UNCANNY X-MEN #145.

### Statistics:

Fighting: EXCELLENT (20)  
Agility: INCREDIBLE (40)  
Strength: REMARKABLE (30)  
Endurance: REMARKABLE (30)  
Reason: TYPICAL (6)  
Intuition: TYPICAL (6)  
Psyche: TYPICAL (6)  
Health: 120  
Karma: 18  
Resources: GOOD (10)  
Popularity: 0/5 in Latveria





**Powers:** The ability scores listed above represent the four soldiers' enhanced stats while wearing their battle suits. Powers below are in each suit of armor.

*Asbestos Net:* Each Doom Squad soldier can shoot a net from his chest plate up to 1 area away. Treat this as a Remarkable ensnarement attack on the Grappling column. The net has Remarkable (30) material strength. Against fire attacks, it is considered to have Amazing (50) material strength.

*Body Armor:* The suits grant the wearers Remarkable (30) protection from energy and physical attacks.

*Flight:* From jets in their boots, the Doom Squad can fly at Good (10) air speed (8 areas per round).

*Force Bolts:* Each arm of the battle suit ends in a steel ball. An Amazing (50) Intensity force blast can be fired from each ball up to a range of 20 areas.

*Grapple-Lines:* Six small holes lining the chest plate of each battle suit enable the wearer to fire steel cables at a target up to 1 area away. Treat this as an Incredible ensnarement attack. The cables have Incredible (40) material strength.

*Infrared Scanners:* The battle suits' helmets allow the Doom Squad to detect heat sources at Remarkable (30) rank, enabling them to see invisible persons.

**Talents:** Military, Martial Arts A and B.

**Role-Playing Notes:** The members of the Doom Squad were hand-picked by Doctor Doom from the ranks of his human troops. They follow his orders out of both fear and respect. They rely heavily on the powers of their battle suits, and if their suits appear ineffective, the Doom Squad is not above a "strategic retreat."

**Material Strength:** Remarkable (30).

**Tech Rank:** Unearthly (100).

**Availability:** Doctor Doom had one Doom Squad, which consisted of four of his "best soldiers" in high-tech battle suits. Only one of them escaped defeat in their encounter with the X-Men, though his punishment for failing Doom may have been far worse than defeat at the mutants' hands.

### Electro-Shock Pistol

This weapon looks like a high-tech pistol made entirely of metal. It was designed by Doctor Doom specifically to defeat the Human Torch, and given to one of Doom's robotic minions. "The master has provided appropriate weapons for dealing with each of you!" exclaimed the warrior robot. "For the Human Torch ... a close-range electro-shock pistol!" ZAP!

**First Appearance:** FANTASTIC FOUR #84.

**Powers:**

*Shock Bolt:* The weapon fires a bolt of intensified electricity up to 1 area away. If hit, the victim suffers Remarkable (30) electrical damage, and must succeed at a Remarkable (30) Intensity Endurance FEAT or be rendered unconscious for 1-10 rounds. If the Human Torch is the victim, he loses the power to "flame on" for 1-10 rounds, even if he is not knocked unconscious. An electro-shock pistol can be fired once per turn, and can be shot 12 times before needing a recharge.

**Material Strength:** Excellent (20).

**Tech Rank:** Unearthly (100).

**Availability:** A dozen of these weapons are stored in the armory of Castle Doom, and are most commonly employed by warrior robots.



## Electronic Shackle

This small metal band is covered with electronic circuitry. When placed around a character's wrist, the pain the shackle generates prevents the character from focussing or using his or her powers.

**First Appearance:** FANTASTIC FOUR #198.

### Powers:

*Pain Impulse:* When a character wearing an electronic shackle tries to use a power, his body is wracked with intense pain by impulses fired directly into his or her nerves. The character must attempt an Incredible (40) Intensity Psyche FEAT roll. If successful, the wearer overcomes the pain and may use his power. If the roll is missed, the character surrenders to the pain and must stop trying to use his power.

**Material Strength:** Remarkable (30).

**Tech Rank:** Incredible (40).

**Availability:** Dr. Doom has a dozen of these restraints at his disposal, all stored within Castle Doom.

## Energy Fist

This small apparatus can be added to the interior of either gauntlet of Doctor Doom's armor. It enables him to create a huge fist comprised of pure energy, which he can use to grasp, smash, or crush opponents.

**First Appearance:** FANTASTIC FOUR #312.

### Powers:

*Energy Fist:* When activated, energy bursts from Doom's gauntlet, extending up to 2 areas away and forming a huge energy-hand. Doom can use it to make grappling, grabbing, or blunt attacks of Amazing (50) Strength.

**Material Strength:** Typical (6).

**Tech Rank:** Shift Z (500).

**Availability:** This weapon exists in only one of Doom's gauntlets. It is unknown whether plans exist, but the gauntlet is in one of Doom's hidden New York lairs.

## Enlarger Ray

After being subjected to his own reducing ray, Dr. Doom found himself trapped within an alternate dimension called the Microverse. Doom tricked the rulers of Microworld into appointing him the court scientist, and his technical genius soon allowed him to take over the world. During his stay, he created the enlarger ray, which enabled him to return to Earth.

**First Appearance:** FANTASTIC FOUR #16.

### Powers:

*Growth:* The device emits a wide beam that fills the area directly in front of it with glowing energy, causing characters to grow at Shift X (150) rank. Characters affected by the ray while in the Microverse grow until they suddenly appear on Earth at their normal size.

**Material Strength:** Good (10).

**Tech Rank:** Shift X (150).

**Availability:** Doctor Doom built one enlarger ray that still exists on Microworld.

## Excavator

This looks like a small rocket, reinforced for tunneling. It bores through the earth by blasting the rock in front of it, and has space to seat ten passengers.

**First Appearance:** ASTONISHING TALES (Vol. 1) #6.

### Statistics:

Control:	EXCELLENT (20)
Speed:	UNEARTHLY (100)
Body:	INCREDIBLE (40)



**Powers:**

*Rocket Boring:* The excavator rockets its way through the earth at up to Unearthly (100) land speed (10 areas per turn). If boring at Poor (4) speed (2 areas per round) or less, the excavator leaves a tunnel behind it. If traveling at greater than Poor (4) speed, it leaves only churned earth behind it.

*Compartmentalization:* The vessel is divided into three airtight compartments—forward, midships, and aft. Each section has Incredible (40) body.

**Material Strength:** Incredible (40).

**Tech Rank:** Shift X (150).

**Availability:** Doctor Doom has one working excavator, and its whereabouts are unknown.

**Fingertip Darts**

One of Doctor Doom's more devious tricks is to fire poisoned darts from the fingertips of his armor. The darts are made of steel, and the poison is quite deadly.

**First Appearance:** SUPER-VILLAIN TEAM-UP #7.

**Powers:**

*Poison Darts:* The darts can only hit targets within the same area as Doctor Doom. The darts cannot penetrate body armor or force fields of Good (10) rank or higher. Attacks are made on the Shooting column and victims hit must attempt an Excellent (20) Intensity Endurance FEAT. If successful, the target is not poisoned. If the roll is failed, the target is poisoned. The poison takes effect after 1-10 turns. At this time, the victim must roll against his Endurance on the Kill Column of the Battle Effects Table to determine the final effects of the poison.

**Material Strength:** Excellent (20).

**Tech Rank:** Incredible (40) (darts); Excellent (20) (poison).

**Availability:** Doctor Doom can have up to eight darts fixed into his armor at once. It is likely that he has a wide variety of darts, with various types of poisons, secured in all of his laboratories.

**Floating Laboratory**

This huge complex is a flying, cigar-shaped vehicle. It has the power to create a normal-looking cloud around itself, and can thus float hidden over populated areas. Along with the master control room, the vessel contains laboratories, armories, food stores, generators, and several trap chambers to hold captured heroes.

**First Appearance:** FANTASTIC FOUR #17.

**Statistics:**

Control: GOOD (10)  
Speed: REMARKABLE (30)  
Body: REMARKABLE (30)

**Powers:**

*Cloud Generation:* The floating laboratory cloaks itself in a dense cloud of Remarkable (30) Intensity, hiding it from normal vision.

*Disintegration Field:* The ship is surrounded by a thin layer of dimly shimmering light. Any creature passing through the light which the ship's computers identify as an intruder suffers Amazing (50) energy damage and must roll against his Endurance on the Kill Column of the Battle Effects Table.

*Flight:* The ship moves by means of anti-gravity suspensors, and can hover in place for an indefinite amount of time. Its top air speed, dropping the cloud cover, is Typical (6) (8 areas per turn).

**Material Strength:** Remarkable (30).

**Tech Rank:** Shift X (150).

**Availability:** Doctor Doom built one floating laboratory. It could be discovered hovering virtually anywhere over the Earth. Doom uses it as a mobile, hidden sanctuary where he can retreat from the world.

## Force Cage

This device was designed specifically to imprison the Invisible Woman. It consists of a round metal pedestal and a separate control panel. When the captive is placed in the pedestal, and switches on the control panel thrown, shimmering bars of force spring into existence, forming a sphere around the prisoner.

**First Appearance:** FANTASTIC FOUR #288.

### Powers:

*Force Bars:* The Incredible (40) rank bars of force are attuned precisely to the mental energy frequencies of the force fields created by the Invisible Woman. If she should try to use her force field to escape, the mental feedback causes her Incredible (40) Intensity damage, and the bars remain in place. Physically breaking out of the cage requires a successful Incredible (40) Intensity Strength FEAT.

The control panel can also be used to deactivate the cage. The panel has Good (10) material strength.

**Material Strength:** Remarkable (30) (cage floor); Good (10) (control panel).

**Tech Rank:** Monstrous (75).

**Availability:** Doctor Doom has one of these beneath his embassy in New York City. It is certainly likely that he has another at one of his castles in Latveria.

## Freeze Grenade

This is Victor Von Doom's first recorded invention, dating back to a time before he was known as Doctor Doom. While travelling with a Gypsy caravan, Victor used the grenade to engulf a tank, which was firing upon the wagons, freezing it in a semi-solid mass of ice. A freeze grenade looks something like a metallic melon, capable of being held and thrown with one hand.

**First Appearance:** FANTASTIC FOUR ANNUAL #2.

### Powers:

*Ice Generation:* Upon time detonation or impact, the Remarkable (30) rank freeze grenade covers a circular area about 30' in diameter with a snowy mass of ice. All targets within this region who fail a Yellow Agility FEAT are ensnared and all FEATs and actions are reduced by -3CS while within the area of effect. Breaking free requires a successful Remarkable (30) Intensity Strength FEAT. Given time, the ice will melt like ordinary ice.

**Material Strength:** Good (10).

**Tech Rank:** Monstrous (75).

**Availability:** Victor has not employed this device since his youth. Since he considers it a mere toy, it is unlikely that he has any in his arsenal (though he may have one in Castle Doom as a memento).

## Grabber

This is one of Doctor Doom's oldest inventions, and perhaps one of his most potent. The grabber is a small foot-long cylinder, and is activated and controlled by a hand-held remote-control device. The cylinder is magnetically attracted to the remote-control, and will lift virtually anything to move toward the hand-held gadget. Doom used the grabber to lift the entire Baxter Building into Earth's upper atmosphere.

**First Appearance:** FANTASTIC FOUR #6.

### Powers:

*Magnetic Manipulation:* Once the cylinder is fixed to an object, the remote-control is activated. The cylinder then flies toward the remote-control, bringing the object it is attached to along with it. The cylinder's magnetic pull has Shift X Strength, enabling it to lift over 100 tons. For the grabber to function, the remote-control must remain within 20 areas of it.

**Material Strength:** Remarkable (30) (cylinder); Good (10) (remote-control).





**Tech Rank:** Shift X (150).

**Availability:** The original grabber was thrown into the Atlantic Ocean by the Sub-Mariner; a second grabber used by Dr. Doom II (Kristoff) was destroyed with the Baxter Building at the edge of Earth's orbital space.

### Grappler Ray

This device is a type of tractor beam which uses invisible waves of force to gently bring the target toward the machine. Doom used this ray to kidnap Alicia Masters, her kidnapping being reported by eyewitnesses as she seemed to walk on air!

**First Appearance:** FANTASTIC FOUR #17.

#### **Powers:**

*Tractor Beam:* The invisible waves of this strange machine can be extended up to Shift Z (500) range (400 areas). It is so accurate it can affect a specific individual walking among a crowd of hundreds. The target is gently, but rapidly, pulled toward the machine. Breaking free of the grappler ray requires a successful Excellent (20) Intensity Strength FEAT.

**Material Strength:** Excellent (20).

**Tech Rank:** Shift Z (500).

**Availability:** Doctor Doom has one grappler ray fitted into his floating laboratory.

### Guardian Robot

Riding on three wheels, these non-humanoid robots have two tentacle-like steel arms and a glowing dome for a head, from which their weapons are fired. These machines are put into action in times of need to patrol the grounds of Castle Doom and Doomstadt, control the populace, and find and defeat any intruders.

**First Appearance:** FANTASTIC FOUR #198.

#### **Statistics:**

Fighting: GOOD (10)  
Agility: GOOD (10)  
Strength: TYPICAL (6)  
Endurance: GOOD (10)  
Reason: POOR (4)  
Intuition: POOR (4)  
Psyche: POOR (4)  
Health: 36  
Karma: N/A

#### **Powers:**

*Body Armor:* Guardian robots are made of Typical (6) strength materials, and have Typical (6) rank body armor as a result.

*Computer Link:* The robots are in direct communication with Doom's various security systems and with each other. When an alarm is raised, they respond depending upon the situation. The maximum range of the link is 10 miles (though robots on border patrol relay trouble to Castle Doom through secondary robots within range).

*Elongation:* They have the Feeble (2) power to extend their steel tentacles up to 1 area away and grapple or hit opponents. Their tentacles have Excellent (20) material strength and deal Good (10) blunt damage or Excellent strength grappling.

*Force Blaster:* These robots are usually armed with blasters of Excellent (20) Intensity force and a range of three areas.

*Ionic Laser:* When Doom is expecting a super-powered assault, he fits his guardian robots with these weapons. An ionic laser fires an Incredible (40) rank energy blast up to a range of 11 areas.

*Knock-Out Gas:* Guardian robots can spray knock-out gas up to 1 area away. Everyone in the target area must succeed at an Incredible (40) Intensity Endurance FEAT or fall unconscious for 1-10 turns.

*Mobility:* Guardian robots can move at Good (10) ground speed (4 areas per turn) over passable terrain.

*Robotic Form:* Guardian robots cannot be affected by mental or emotional attacks or illusions. However, they can be harmed by powers that affect machinery.

**Talents:** None.

**Role-Playing Notes:** Guardian robots are a mindless police force protecting Latveria from outside invaders. They enforce Doom's laws without any compassion or thought for humanity, as they are programmed to.

**Material Strength:** Typical (6).

**Tech Rank:** Amazing (50) (standard); Unearthly (100) (with ionic laser).

**Availability:** Doctor Doom has at least 100 guardian robots patrolling his castles and Latveria's borders.

### Gyroscopic Aircraft

This aircraft is a cross between a huge spinning top and the typical flying saucer. It is big enough to contain a small laboratory, armory, storage chamber, and up to 50 warrior robots.

**First Appearance:** FANTASTIC FOUR #39.

**Statistics:**

Control: EXCELLENT (20)  
Airspeed: SHIFT Z (500)  
Body: INCREDIBLE (40)

**Powers:**

*Flight:* Through some form (or combination) of magnetic or gravity manipulation, the gyroscopic aircraft can attain Shift Z (500) airspeed (200 areas per turn).

*Laser Cannons:* The vessel contains six laser cannons which shoot beams of Incredible (40) Intensity energy out to a range of 11 areas.

**Material Strength:** Incredible (40).

**Tech Rank:** Class 1000.

**Availability:** Doctor Doom owns one gyroscopic aircraft, and it is stored in a hidden hangar in the hills surrounding the Citadel of Doom.

### Hawk Scanner

From a distance, this robot looks exactly like a large hawk, but is actually an artificial surveillance device.

**First Appearance:** ASTONISHING TALES (Vol. 1) #6.

**Statistics:**

Fighting: TYPICAL (6)  
Agility: EXCELLENT (20)  
Strength: POOR (4)  
Endurance: GOOD (10)  
Reason: FEEBLE (2)  
Intuition: FEEBLE (2)  
Psyche: FEEBLE (2)  
Health: 40  
Karma: N/A

**Powers:**

*Body Armor:* The hawk scanner has Typical (6) rank body armor versus physical and energy attacks.

*Energy Blast:* Inside its mouth is a Remarkable (30) strength energy blaster with a range of 8 areas.

*Flight:* The hawk scanner can soar at up to Unearthly (100) airspeed (40 areas per turn).

*Material Detection:* It can detect and trace specific materials (such as vibranium) with Excellent (20) ability.

*Remote Control:* Doctor Doom controls the hawk from within his castle; control range is set at 5,000 miles.

*Robotic Form:* A hawk scanner is not affected by mental or emotional attacks or illusions. It is affected by powers that can harm machinery.

**Talents:** None.

**Role-Playing Notes:** A hawk scanner is a surveillance machine that has no independent thought.

**Material Strength:** Typical (6).

**Tech Rank:** Unearthly (100).

**Availability:** Dr. Doom built one hawk scanner and had it destroyed after it found vibranium in Wakanda.





## Hologram Projector

This apparatus consists of two separate parts—a hand-held projector and a button-sized transmitter. When activated, the projector displays a holographic image in the air depicting events occurring where the transmitter is located. Doctor Doom outfits his Doombots and other minions with transmitters to observe their actions.

**First Appearance:** AVENGERS #332.

### Powers:

*Holographic Projection:* The transmitter must be within 11 areas (Incredible range) of the projector. A three-dimensional image of what is happening in the area of the transmitter can be displayed in the air before the projector. Up to three separate holograms from different transmitters can be displayed at once.

**Material Strength:** Typical (6) (projector); Poor (4) (transmitter).

**Tech Rank:** Incredible (40).

**Availability:** At least one of these devices is known to be in the possession of Dr. Doom, and could be stored in the Latverian Embassy.

## Hyper-Sound Piano

In an elegant room within Castle Doom, there appears to be a normal grand piano. With Doctor Doom at the keyboard, however, the piano is an instrument of death. Attached to the piano above the keyboard is a music stand, which also serves as a video monitor. Any room of the castle can be viewed on the monitor. When a specific combination of chords is played on the piano, the musician can direct ear-shattering sonic blasts into the room on the monitor, potentially killing everyone or only one specific target inside.

**First Appearance:** FANTASTIC FOUR #87.

### Powers:

*Hyper-Sound:* Sonic blasts can be directed to any room within Castle Doom (not outside), and everyone in the room whose ears are not protected suffers a Remarkable (30) Intensity sonic energy attack each round the music plays. The character at the keyboard can direct the hyper-sound at one specified individual. In this case, the sonic blast is intensified, resulting in an Incredible (40) rank sonic energy attack. Only Doctor Doom knows the proper sequence of chords which must be played to unleash a sonic blast.

**Material Strength:** Poor (4).

**Tech Rank:** Incredible (40).

**Availability:** Doctor Doom owns two of these elegant-looking instruments of death; one stands quietly in an elegant dining hall within Castle Doom and the other rests in the sitting room of the Fortress of Doom in the Adirondacks of New York.

## Hypno-Persuader

This devious machine consists of four rectangular tables radiating from a central pillar in a cross pattern. The pillar is made of metal, and is covered with various mechanisms and computer circuitry. At the head of each table is a helmet, which is placed upon the head of the subject. The hypno-persuader can affect up to four subjects at once.

**First Appearance:** FANTASTIC FOUR #85.

### Powers:

*Persuasion:* The hypno-persuader can subliminally force a character to believe a single statement (whether true or false), such as "Doctor Doom is your friend," or "Your powers no longer work." While the character lies sleeping on the table, the specified statement plays over and over on speakers inside the helmet. A different statement can be played through each of the four helmets at the same time.

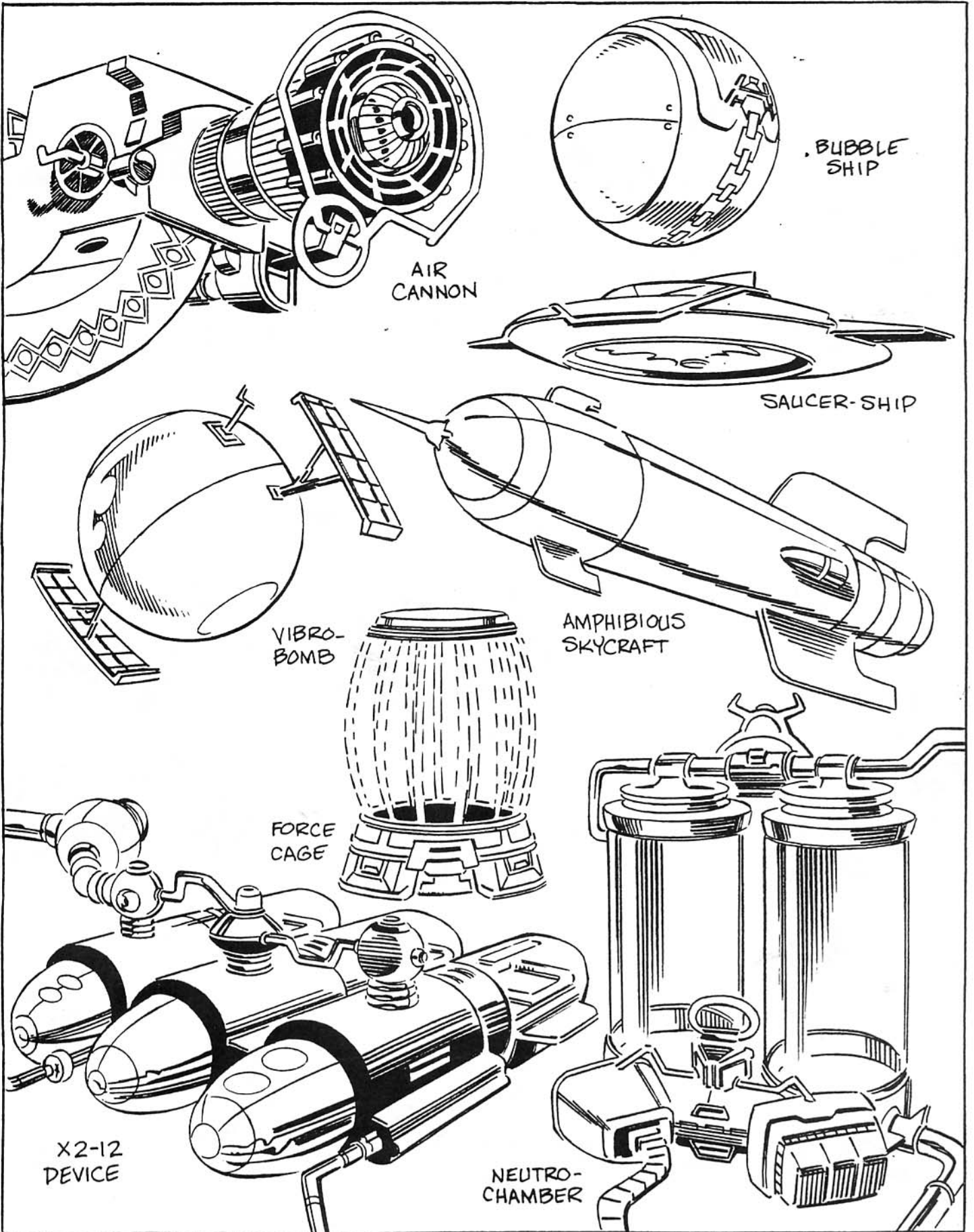



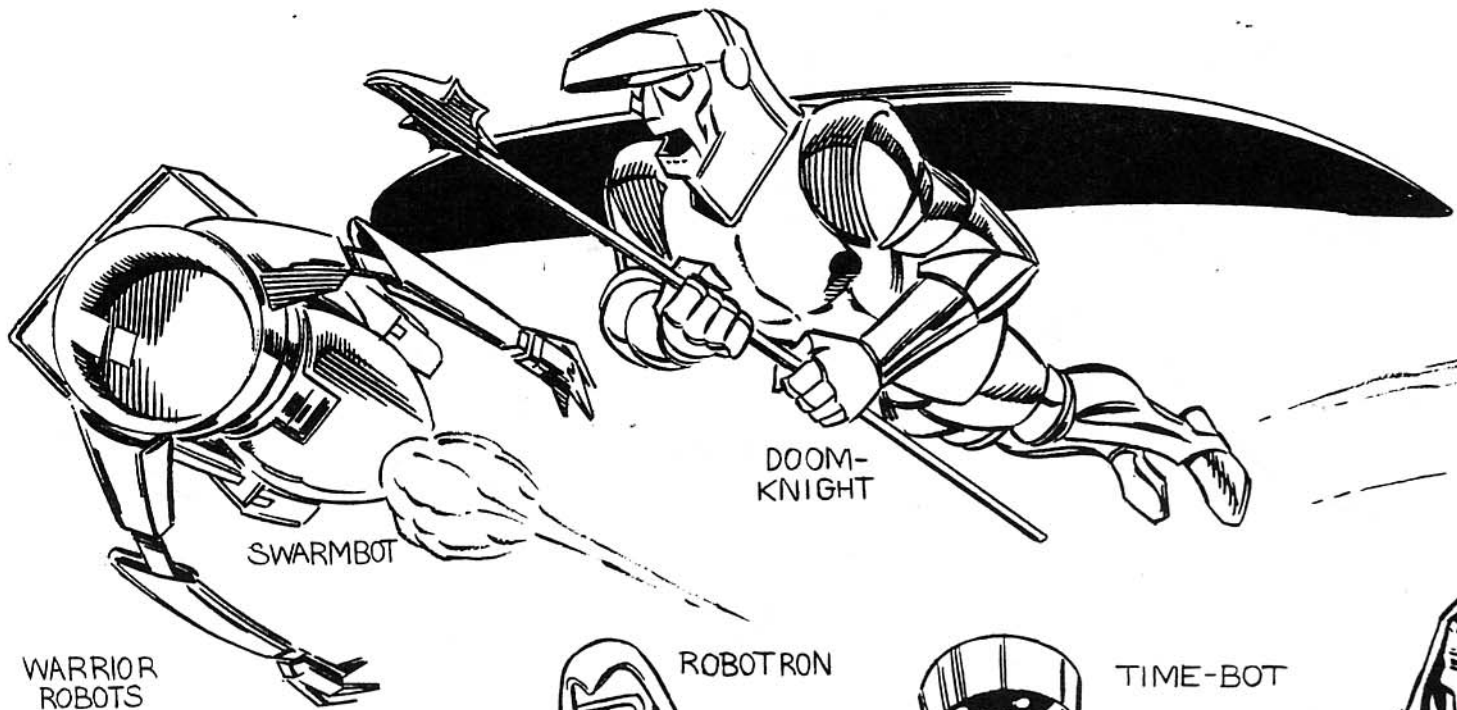

SWARMBOT

DOOM-KNIGHT

WARRIOR ROBOTS



ROBOTRON

TIME-BOT

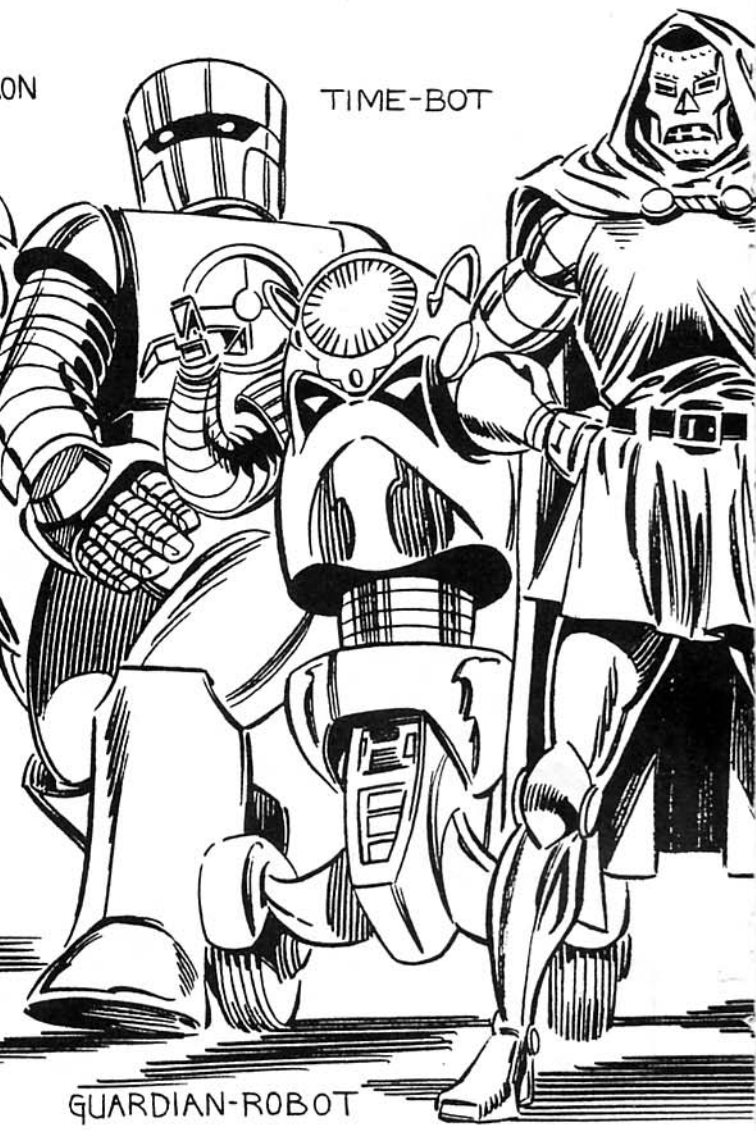

SEEKER

GUARDIAN-ROBOT



DOOM SQUAD

DOOMSMAN II

INVINCIBLE ROBOT

DOOMS MAN I

SILENT STALKER

PACIFIER ROBOT



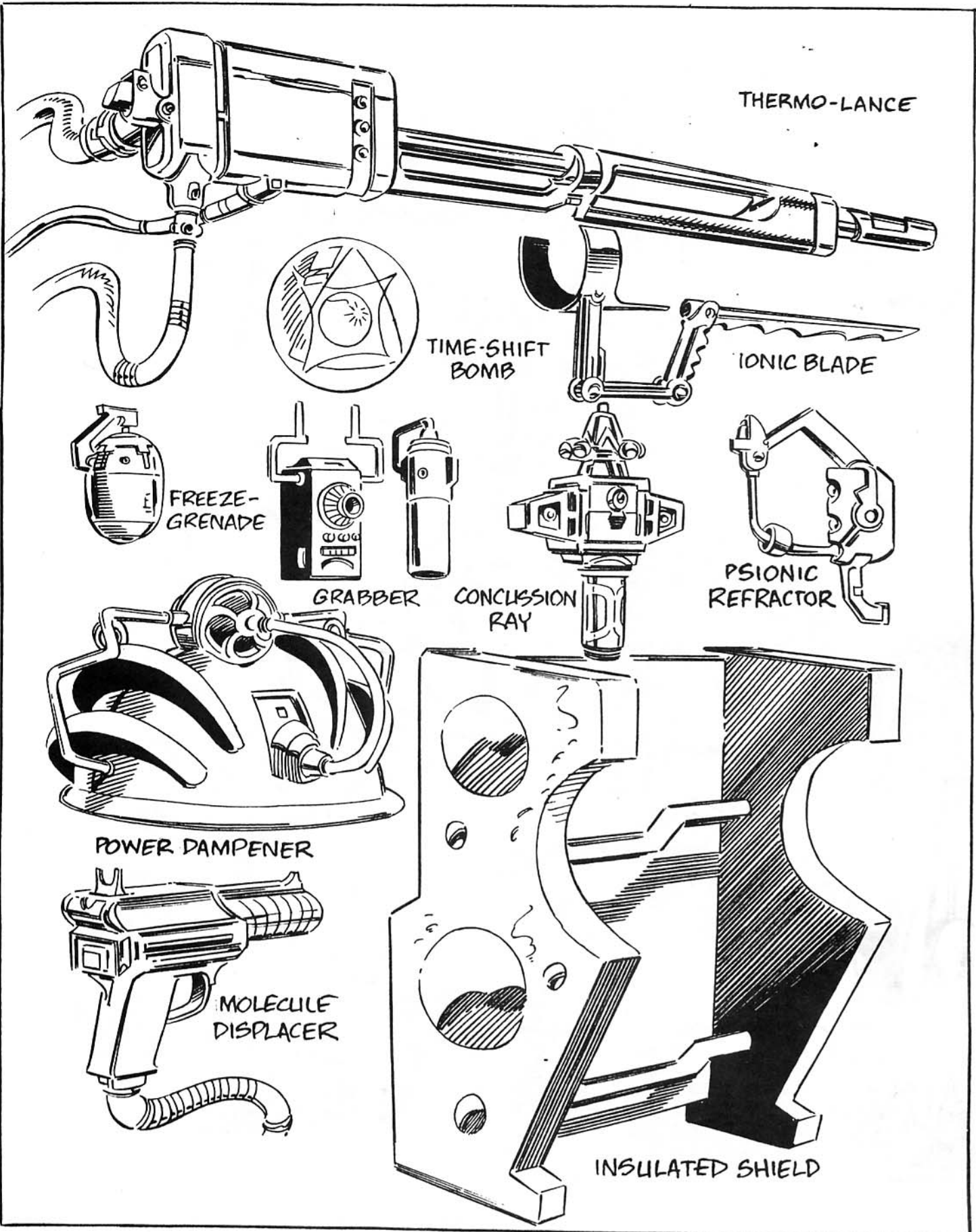

THERMO-LANCE

TIME-SHIFT BOMB

IONIC BLADE

FREEZE-GRENADE

GRABBER

CONCUSSION RAY

PSIONIC REFRACTOR

POWER DAMPENER

MOLECULE DISPLACER

INSULATED SHIELD

Each round a character is subjected to the hypno-persuader, he or she must attempt a Remarkable (30) Intensity Psyche FEAT. If successful, the character has resisted for one round, and must continue to attempt Psyche FEAT rolls each round until the machine is switched off, the Psyche FEAT is missed, or he or she somehow escapes. If a Psyche FEAT is missed, the character truly believes the statement that has been programmed into his or her brain over and over again.

Persuasion lasts until something occurs to directly contradict the induced statement. Each time this happens, the character is allowed a Remarkable (30) Intensity Psyche FEAT roll. If successful, the persuasion is broken and the character realizes what has been done to him. If the roll is missed, the persuasion continues until another event occurs and another Psyche FEAT is attempted.

A hero who believes his powers are gone may attempt a Psyche FEAT roll whenever he encounters a situation in which he would normally use his powers. Suppose the Thing, who believes his strength is gone, punches a warrior robot. The Thing may attempt a Remarkable (30) Intensity Psyche FEAT. If successful, he realizes his strength was never really gone at all.

A character can be persuaded to believe only one statement at one time—a hero cannot be forced to believe both that Doom is his friend and that his powers are gone!

**Limitation:** This device only affects organic beings, and consequently has no effect upon robots or androids.

**Material Strength:** Excellent (20).

**Tech Rank:** Monstrous (75).

**Availability:** Dr. Doom owns one hypno-persuader, and it is kept in the upper laboratories in Castle Doom. It could have been improved beyond its original capabilities and used to reprogram the Fantastic Four to fit into their "puppet lives" in Liddleville (see "Places of Interest" in the Domains of Doom book).

## Hypnopticon

This cumbersome, immobile machine allows the user to place hypnotic commands in the minds of others.

**First Appearance:** DAREDEVIL #37.

### Powers:

*Hypnotic Control:* The machine affects all characters (excluding the operator) within 3 areas of it. Flashes of light flutter around the device, and characters within range must succeed at an Excellent (20) Intensity Psyche FEAT roll or stand motionless, staring at the lights. People with protected or no vision are immune.

Once a character is dazzled by the lights, the operator of the machine can induce a hypnotic command that takes effect immediately or lies dormant until triggered by future conditions (a post-hypnotic suggestion). A maximum of 1-10 commands can be implanted per individual. Each command takes one round to induce, at which time the victim is allowed another Excellent (20) Intensity Psyche FEAT. Success means the character breaks free of the hypnosis and can ignore the previous command (but is still affected by other commands already induced).

If planted commands cause characters to take an action against their morals, the character is allowed an Excellent (20) Intensity Psyche FEAT roll when the action occurs. If successful, the hero resists the hypnotic suggestion. If the roll is missed, the character performs the action, and may lose Karma.

A hypnotic command has a duration of 2-20 rounds. In the case of a post-hypnotic suggestion, the duration only includes the time the command is actually in force.

**Material Strength:** Typical (6).

**Tech Rank:** Monstrous (75).

**Availability:** Doctor Doom has one hypnopticon installed in his lab at the Latverian Embassy in New York City.





### Idento-Disc and Robot

These are tiny, tissue-thin plastic discs which serve as homing devices. Each disc is remotely linked to one of Doctor Doom's "lighter-than-air robots," which look like overweight, bald men. The robots, which are really just holograms that can fly and pass through solid objects, follow and spy upon whoever is wearing the disc.

**First Appearance:** FANTASTIC FOUR #17.

**Statistics:** Because the robots are merely non-living images, all of their attributes are Shift 0.

**Powers:**

*Computer Link:* The lighter-than-air robots relay a video image of what they are "seeing" (everything visual within their occupied area) to Doom's control panel.

The robots' computer links have a range of 5 miles.

*Flight:* The robots can fly at Typical (6) airspeed (6 areas per round).

*Phasing:* The robots are always at zero density, and can pass through solid objects with Remarkable (30) ability.

*Robot Link:* Each idento-disc acts as a homing device for one lighter-than-air robot. The disks have a range of 40 areas once activated, drawing the robot to within one area of the disc. If the disc is removed from its target, the robot immediately vanishes.

**Talents:** None.

**Role-Playing Notes:** The lighter-than-air robots are totally mindless. They are simply floating spy cameras with minimal to no physical substance.

**Material Strength:** Poor (4) (disc); Shift 0 (robot).

**Tech Rank:** Shift Z (500).

**Availability:** Doctor Doom built four of these devices, which he used to badger the Fantastic Four. Although their powers were useless against the robots, the heroes soon found the discs and removed them.

### Image Projector

This small device can be placed within either arm of Doctor Doom's armor. To activate it, he merely flips open a hinged bit of armor and presses a button. Immediately, a lifelike projection of Doctor Doom appears nearby. He uses the image mainly as a decoy, especially when infiltrating an opponent's stronghold.

**First Appearance:** SUPER-VILLAIN TEAM-UP #2.

**Powers:**

*Image Projection:* The device performs this power at Amazing (50) rank. The image appears anywhere Doctor Doom chooses up to a maximum of 20 areas away. He must always remain within 20 areas of it, or the image automatically vanishes. Doctor Doom can see, hear, and speak through the image. He can also use any of his armor's powers through the image, but at -2CS power rank. The projected form has a Health of 50, and if its Health is reduced to zero, it vanishes. Damage to the image is not inflicted upon the real Doctor Doom.

**Material Strength:** Poor (4).

**Tech Rank:** Shift Z (500).

**Availability:** Doctor Doom has one of these gadgets in his laboratory within Castle Doom.



## Inhibitor Ray

Exactly what this device looks like has never been revealed. Apparently, Doctor Doom can have the inhibitor ray added to his armor without the device being obvious. When activated, the inhibitor ray makes it very difficult for Doom's enemies to direct any attacks against his person.

**First Appearance:** FANTASTIC FOUR #246.

### Powers:

*Inhibitor Ray:* The device emits an invisible aura around Doctor Doom up to a two area radius. Anyone who approaches within two areas of Doom and wishes to attack him must attempt at an Incredible (40) Intensity Psyche FEAT roll. If successful, the character can attack normally. If the roll is failed, however, the character cannot consciously attack Doom, no matter what the situation. Each time the character tries to attack Doom, he is allowed another attempt at an Incredible (40) Intensity Psyche FEAT. Even after the character leaves the 2-area radius around Doom, the effects of the inhibitor ray persist for 1-10 hours.

**Limitation:** This device only affects organic beings, and consequently has no effect upon robots or androids.

**Material Strength:** Poor (4).

**Tech Rank:** Shift Y (200).

**Availability:** Doctor Doom has one of these devices within Castle Doom and one within the catacombs beneath the Fortress of Doom in the Adirondacks.

## Instant Hypnotism Impulser

This small rectangular device emits high frequency energy pulses that home in on a target's inner ear and disrupt the sense of balance. The impulser can be used as an add-on power to Doctor Doom's armor. When used in this way, it is concealed in the palm of the armor's left gauntlet.

**First Appearance:** FANTASTIC FOUR #40.

### Powers:

*Vertigo Effect:* Doctor Doom can use this power against one target in the same area as Doom. The victim feels very dizzy and must succeed at an Incredible (40) Intensity Endurance FEAT or fall to the ground, unable to move or act for 1-10 turns. The impulser causes no actual damage.

**Limitation:** This device only affects organic beings, and consequently has no effect upon robots or androids.

**Material Strength:** Poor (4).

**Tech Rank:** Shift Y (200).

**Availability:** Doctor Doom has at least one of these ready and waiting in Castle Doom, where technicians can fit it to his armor in a matter of moments.

## Insulato-Shield

This piece of defensive equipment is common in Doom's robot army. Typically, two warrior robots standing beside one another hold the shield in front of them, while two ranks of robots follow behind. The device is entirely made of metal, and affords those holding it protection from the front and sides. Ranks following behind only gain protection from the front.

**First Appearance:** FANTASTIC FOUR #84.

### Powers:

*Body Armor:* An insulato-shield grants those carrying it the equivalent of Remarkable (30) rank body armor against physical and energy attacks from the front or sides. The shield offers no protection against attacks from above, below, or behind.

An insulato-shield weighs 400 pounds. A single character of Good (10) Strength can lift it, but it takes two characters of Good (10) Strength or better to effectively carry it and use it for defense.





**Material Strength:** Remarkable (30).

**Tech Rank:** Incredible (40).

**Availability:** Twenty of these devices are kept within the armory of Castle Doom and are brought into play when heavy resistance or superpowered interference is expected.

### Intensified Molecule Projector

Doctor Doom created an attachment that can be added to either gauntlet of his armor which allows him to fire special intensified synthetic molecules at high velocity. Intensified molecules rapidly grow to the size of boulders when exposed to air, providing Doom with a potent missile weapon with nearly unlimited ammunition.

**First Appearance:** MARVEL SUPERHEROES #20.

#### **Powers:**

*Intensified Molecules:* Streaking forth from Doom's gauntlet, an intensified molecule suddenly grows to the size of a boulder, becoming a deadly projectile. The missile has a range of 11 areas and inflicts Incredible (40) blunt throwing damage. Because of their extremely small size before activation, Doom can carry a virtually unlimited supply of intensified molecules within his gauntlet.

**Material Strength:** Poor (4).

**Tech Rank:** Shift Y (200).

**Availability:** Doctor Doom has an intensified molecule projector, along with a large supply of specialized artificial molecules, at his laboratory within Castle Doom; he also has a working miniaturized model (concealable within one's glove) in a laboratory in the southern Citadel of Doom.

### Invincible Robot

An invincible robot appears like a hulking, green humanoid with facial features much like that of a jack-o-lantern. When it moves, the robot proceeds in a hunched-over, threatening position, making it look something like a mechanical gorilla. Once activated, the robots are very hard to control; if they go on a rampage, there is no stopping them short of their own destruction.

**First Appearance:** FANTASTIC FOUR #85.

#### **Statistics:**

Fighting:	EXCELLENT (20)
Agility:	GOOD (10)
Strength:	INCREDIBLE (40)
Endurance:	INCREDIBLE (40)
Reason:	POOR (4)
Intuition:	POOR (4)
Psyche:	POOR (4)
Health:	110
Karma:	N/A

#### **Powers:**

*Body Armor:* Invincible robots are fashioned of Incredible (40) strength materials, and as a result have Incredible (40) body armor.

*Combat Sense:* These mechanized warriors, armed with Amazing (50) rank combat programs, are high-tech killing machines. An invincible robot can use the power rank of this ability instead of Strength for escaping, instead of Intuition for initiative, instead of Agility for dodging and catching, and instead of Fighting for evading.

*Independent Locomotion:* Even when one of these robots is broken into smaller parts, its limbs can continue the attack! Severed arms and legs fly through the air to slug opponents, and disembodied hands continue to fire any hand-held weapons. Consider independent limbs to have statistics at -1CS from those of the robot as a whole. The Health of an arm or leg is 20.







**Robotic Form:** Invincible robots cannot be affected by mental or emotional attacks or illusions. However, they can be harmed by powers that affect machinery.

**Limitation:** When these robots were first activated, they were so overcome by their killer programming that they ignored Doctor Doom's commands and attacked before he gave the order. Any time an invincible robot is activated, attempt a Reason FEAT for it. On a White result, the robot becomes berserk, attacking the nearest target, but not other invincible robots.

As with all of Doom's mechanical warriors, invincible robots are equipped with a self-destruct mechanism. In this case, these robots do not gain the power of independent limbs, and they are totally obliterated.

**Talents:** None.

**Role-Playing Notes:** Invincible robots are determined killers, their memory banks filled with a single programmed thought, "Destroy! Destroy! Destroy!"

**Material Strength:** Incredible (40).

**Tech Rank:** Unearthly (100).

**Availability:** Over sixty of these robots have been built in the past. While King Zorba ruled Latveria, over 50 invincible robots were sent to kill Doctor Doom, who had returned to Doomstadt (with the Fantastic Four as reluctant allies) to reclaim his throne. All of the robots were destroyed, as was much of Doomstadt. Whether or not Doom will build more of these juggernauts remains to be seen; the wisdom of such actions is doubtful, but the robots' power cannot be denied.

## Ionic Blade

This deadly weapon looks like an energized bayonet or combat knife. The ionic blade can pop out of the right forearm of Doom's armor, ready for use in a second.

**First Appearance:** SUPER-VILLAIN TEAM-UP #12.

## Powers:

**Ionic Blade:** The knife uses ionic energy to slice through objects and other targets, animate or inanimate. The blade causes Incredible edged (40) damage, regardless of the wielder's Strength.

**Ionic Blast:** The knife can fire an ionic bolt up to 1 area away, inflicting Incredible (40) energy damage.

**Material Strength:** Incredible (40).

**Tech Rank:** Unearthly (100).

**Availability:** Doom has one of these blades at his disposal in each of his castles.

## Latverian Guard Weaponry

Doctor Doom has a small contingent of native human Latverian soldiers under his command. Their main function is to guard Castle Doom and patrol the environs of Doomstadt, while showing that Doom also values human troops in addition to his robots. Their statistics conform to typical Latverians, as described in Chapter 2 of the Domains of Doom book; the entry below details the varied weapons given to them by the Master.

**First Appearance:** All of the following pieces of equipment may have appeared previously, but the first substantiated appearance of all this weaponry came in FANTASTIC FOUR #350.

## Powers/Equipment:

**Communicator:** Each soldier's helmet is equipped with a communications device enabling him to remain in verbal contact with Castle Doom's security personnel. Range is five miles.

**Energy Halberd:** These weapons are carried by soldiers patrolling Castle Doom. An energy halberd looks like a normal Medieval polearm, but it can discharge a Remarkable (30) Intensity blast of energy up to 8 areas away. The weapon can also inflict Incredible (40) edged damage in hand-to-hand combat. An energy halberd has Excellent (20) material strength.

**Force Rifle:** This is the standard weapon carried by Latverian soldiers. It fires an Excellent (20) Intensity force beam up to a range of 6 areas, and has enough of a charge for 12 shots before recharging is needed. A force rifle has Good (10) material strength.

**Uniform:** Latverian soldiers look more like they are ready for a parade than for a battle. Their baroque uniforms consist of a tall, plumed helmet, a colorful overcoat with tails, and black, leather thigh-boots, as well as an assortment of silver and gold bangles, buttons and other ornamentation. The uniform, as unconventional as it may seem, is partially made of Kevlar, and affords the troops with Excellent protection from physical attacks.

**Talents:** Military.

**Role-Playing Notes:** Latverian soldiers are brave and effective when defending their homeland from assault, but cowardly and nearly ineffectual when defending their leader from super-powered invaders. However, if Dr. Doom is present on the battlefield, Latverian troops will always fight the super-powered attackers rather than risk their Master's wrath if they failed to do so.

**Material Strength:**

Comm:	POOR (4)
Halberd:	GOOD (10)
Rifle:	EXCELLENT (20)
Uniforms:	FEEBLE (2)

**Tech Rank:**

Comm:	REMARKABLE (30)
Halberd:	INCREDIBLE (40)
Rifle:	MONSTROUS (75)
Uniforms:	FEEBLE (2)

**Availability:** Doctor Doom has 50 Latverian soldiers at his command in the Latverian Guard.

## Memory Transference Machine

Perhaps Doctor Doom's most elaborate invention, the memory transference machine fills one entire chamber within the depths of Castle Doom. The grim monarch created this device as a contingency against his own death. The machine fills the brain of Doom's chosen heir with all of Doom's memories, effectively replacing the personality of the heir with that of Victor Von Doom!

**First Appearance:** FANTASTIC FOUR #278.

### Powers:

**Memory Transference:** A host of five Doombots must operate the machine. The heir is placed in a seat in the device, and a helmet is affixed to his or her head. Doctor Doom's entire recorded history, mind, and memory is fed through the helmet and imprinted upon the memory centers of the heir's brain. When the process is complete, a FEAT roll must be attempted on the machine's Amazing (50) power rank (no Karma may be spent for this FEAT):

- **White:** A system error causes the machine to malfunction—the subject's brain is wiped clean, resulting in total amnesia. Because the heir's brain is now extremely susceptible to imprinting, another attempt can be made with +2CS to the power FEAT roll. However, if another White result is rolled, the heir dies.
- **Green:** The process is partially successful, resulting in Doctor Doom's memories and personality being transferred to the subject.
- **Yellow:** As with Green above, but Doctor Doom's Talents are also transferred.
- **Red:** As with Green and Yellow, but all of Doctor Doom's Talents, mental powers, and magical powers are also transferred.

If the result was Green or better, the heir gains Doctor Doom's Amazing (50) Reason, Incredible (40) Intuition, and Amazing (50) Psyche. The effects are permanent, but the subject's original personality and memories can be restored with the imprinting and use of an encoded post-hypnotic command.





**Material Strength:** Remarkable (30).

**Tech Rank:** Shift Z (500).

**Availability:** Doctor Doom has only one memory transference machine, and it is located within the depths of Castle Doom.

### Metabolic Transmuter

This weapon is simply a small, glowing, chrome ball. When thrown, it has the ability to track its target. If hit, the victim's body transmutes into organic chrome, effectively becoming a living statue.

**First Appearance:** UNCANNY X-MEN #145.

#### Powers:

*Heat-Seeking Sensors:* The missile "locks on" to the heat signature of the person it is thrown at. The metabolic transmuter is only confused or distracted by hotter sources of heat (a car engine or flaming hero, for example). It can only track a person for as far as the thrower can throw it.

*Transmutation:* The victim is allowed an Incredible (40) Intensity Endurance FEAT to try and resist the transformation. If successful, the character is unaffected. If the roll is missed, the character's skin and muscle tissue transmutes into organic chrome. The victim's life processes are slowed to almost nothing. He or she cannot move, and becomes a living statue. Though it immobilizes its target, the chrome skin provides the character with Excellent rank (20) Body Armor.

The transmutation is permanent. However, an antidote exists. It looks exactly like the metabolic transmuter—a glowing chrome sphere. When the antidote hits the target, the transmutation rapidly reverses itself. Judges may also allow a possibility that characters with Regeneration (like Wolverine) could fight the chrome effect after its onset—the greater the Regeneration ability, the shorter the transmutation effect lasts (d100 rounds -power rank).

**Material Strength:** Good (10).

**Tech Rank:** Shift X (150).

**Availability:** Doom used this device (and its antidote) against Storm when the X-Men attacked his Adirondacks castle. It is likely that he has other working models hidden within the labs of that castle.

### Micro-Sentry

Looking like robot spiders, these tiny robots patrol within the circuitry of Doom's armor, and are designed to thwart diminutive intruders such as Ant-Man or other "pests."

**First Appearance:** MARVEL FANFARE #44.

#### Statistics:

Fighting:	GOOD (10)
Agility:	GOOD (10)
Strength:	EXCELLENT (20)
Endurance:	REMARKABLE (30)
Reason:	POOR (4)
Intuition:	POOR (4)
Psyche:	POOR (4)
Health:	70
Karma:	N/A

#### Powers:

*Body Armor:* Micro-sentries are made of Good (10) strength materials and have Good (10) body armor.

*Grapple-Claw:* Located under the robot's "face" is a pincer which it can extend up to 1 area away in order to make grappling, grabbing, or blunt attacks. The grapple-claw has Excellent (20) material strength.

*Robotic Form:* Micro-sentries are immune to mental or emotional attacks and illusions. They can be harmed by powers that affect machinery, however.

**Talents:** None.

**Role-Playing Notes:** Micro-sentries are extermination machines, programmed only to hunt and destroy any organisms (microscopic or otherwise) that invade the interior of Dr. Doom's armor.

**Material Strength:** Good (10).

**Tech Rank:** Shift Y (200).

**Availability:** Doom's suit of armor is patrolled by 20 micro-sentries at all times. It's logical to assume a number of them are in storage and ready for use.

### Mini-Missile Launcher

This short-barreled weapon can be fixed to either gauntlet of Doom's armor. It fires small heat-seeking mini-missiles which are quite powerful for their size.

**First Appearance:** AVENGERS #332.

#### Powers:

*Heat-Seeking:* The weapon homes in on the strongest heat source within its range. The mini-missile is only sidetracked by stronger heat sources. The missile explodes on contact, inflicting Incredible (40) edged damage to the target only. A mini-missile has a range of 11 areas, at which point it runs out of fuel and self-destructs. The launcher can hold up to three mini-missiles.

**Material Strength:** Excellent (20).

**Tech Rank:** Incredible (40) (launcher); Incredible (40) (mini-missiles).

**Availability:** Doctor Doom currently has only the plans for the mini-missiles and their launcher in the Latverian Embassy in New York. The only working models were destroyed and impounded by the Avengers after they were used by Doombots in an attack on Avengers Headquarters.

### Molecular Cage

Although this prison was specifically designed to hold the Thing, it was actually used to just as effectively imprison the sensational She-Hulk. The cage consists of a circular platform made of steel and a separate control panel. When a captive is placed on the platform, and the control panel is activated, a hemispherical web of invisible monomolecular chains springs into being, completely surrounding the prisoner.

**First Appearance:** FANTASTIC FOUR #288.

#### Powers:

*Molecular Web:* Because it is made of strands one molecule wide, the web is invisible to the naked eye. Anyone passing through the web suffers Monstrous (75) edged attack damage, and will likely be sliced into numerous pieces. The strands ignore physical Body Armor, cutting through it as easily as normal materials, and can even cut the Thing's thick hide by design. The control panel can shut off the web.

**Material Strength:** Good (10)

**Tech Rank:** Shift X (150).

**Availability:** Doctor Doom has one of these cages within the Latverian embassy in New York City, and it is possible that another exists within Castle Doom.

### Molecule Displacer

This weapon looks like a futuristic pistol. Doctor Doom carries it as a sidearm when on missions that require its special ability. The molecule displacer has the power to break down and absorb a character's very molecules!

**First Appearance:** THOR #182.

#### Powers:

*Molecular Displacement:* When fired, the molecule displacer emits a thin beam of energy up to a range of 8 areas. Use the Shooting column of the Battle Effects



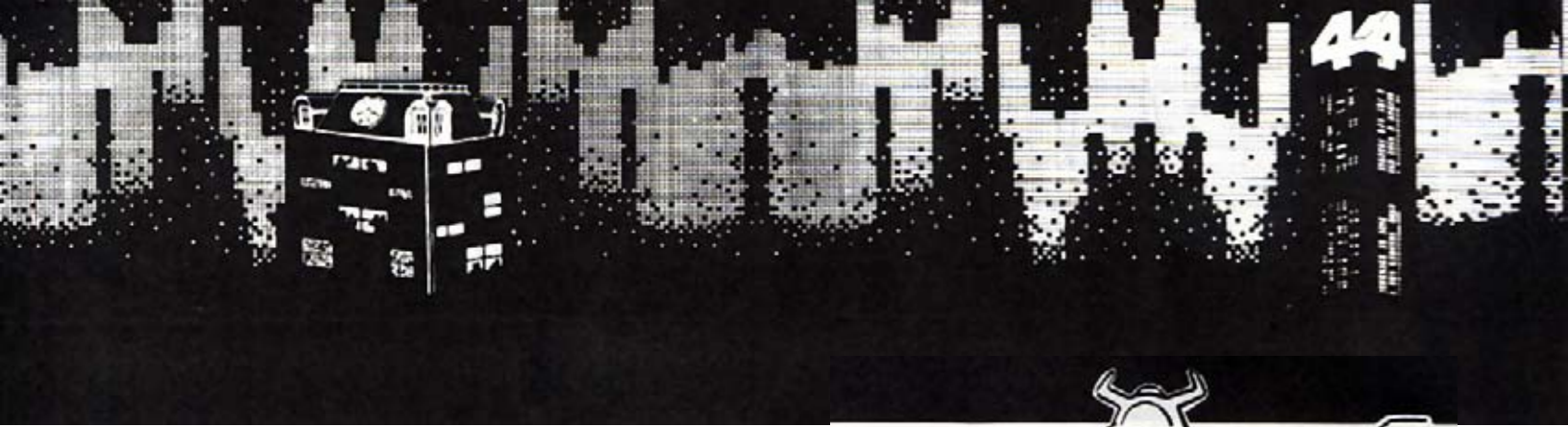

Table, but treat any bull's-eye or kill result as simply a hit. If the target is struck, the victim suddenly vanishes in a kaleidoscopic flash of light. The character has been broken down into his or her composite molecules, which travel along the beam of energy and are absorbed into the weapon's storage unit. The molecule displacer can hold only one character or object at a time. Any of the victim's equipment is also absorbed.

The next time the molecule displacer is fired, the wielder has two options: either restore the victim whole and unharmed at the point where the energy beam strikes, or scatter his molecules over a wide area, effectively killing him. Maximum range of the beam is still 8 areas.

A character can safely be contained within the weapon for 1-10 days. After this time, the displacer automatically discharges (25% chance of an explosion, destroying the device) but the restored victim suffers permanent damage of the Judge's choosing (such as loss of a power, a missing limb, or other disfigurement).

**Material Strength:** Excellent (20).

**Tech Rank:** Unearthly (100).

**Availability:** Doctor Doom created one molecule displacer, which he used to capture Doctor Donald Blake (alias Thor). Even Doom realizes this weapon's diabolical power, and has never used it as a killing device.

### Multi-Dimensional Transference Center

This machine was built by Doctor Doom to send subjects into other dimensions. It consists of a large computer console with up to eight glass cylinders connected to it by steel cables. Each person to be "transferred" is placed in a cylinder. When the machine is activated, the subject vanishes and reappears in the target dimension.

**First Appearance:** DAZZLER #4.

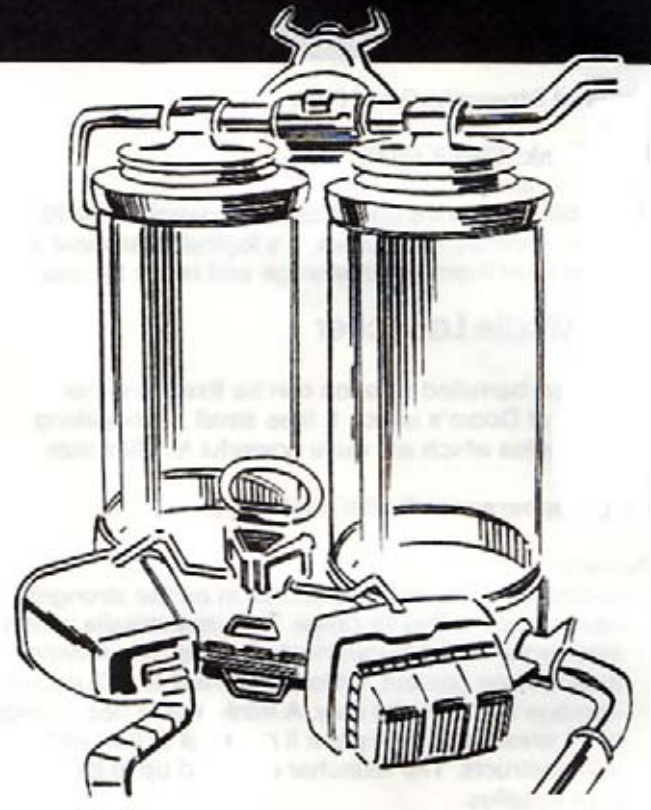

### Powers:

**Dimensional Travel:** The machine's Amazing (50) power easily breaches dimensional barriers, but the rank is checked as a FEAT roll to determine the exact destination. Multiple travelers all arrive at the same place. The FEAT may have the following results:

- *White:* The subject arrives in a random location in a dimension of the Judge's choice.
- *Green:* The subject arrives in a random location within the desired dimension.
- *Yellow:* The traveler arrives 10-100 areas away from the desired location within the desired dimension.
- *Red:* The traveler arrives exactly at the target point within the chosen dimension.

The controller of this device can watch the travelers on a video monitor. The controller can instantly bring the travelers home along with anything they carry with them from the other dimension.

**Material Strength:** Good (10).

**Tech Rank:** Shift X (150).

**Availability:** Doctor Doom has one working model of this machine in a secret lab somewhere in New York City.

### Nerve Impulse Scrambler

This tiny weapon can be added to a finger on one of Doom's gauntlets. It emits a thin beam that interrupts and scrambles nerve impulses to the target's brain, causing the victim to lose control of his physical actions.

**First Appearance:** INCREDIBLE HULK #349.

#### Powers:

*Nerve Scrambler:* The beam can be fired to a range of 4 areas. If the target is hit, he must attempt an Incredible (40) Intensity Endurance FEAT. If successful, the target is unharmed by the ray. If the roll is missed, the target falls to the ground and is totally paralyzed for 1-10 turns. No other damage is caused by the weapon.

**Material Strength:** Poor (4).

**Tech Rank:** Shift Z (500).

**Availability:** Doom keeps one of these weapons in each of his laboratories, where it can be added to his armor if necessary.

### Neuro-Space Field

This small item can be added to the inside of the chest plate of Doom's armor. It is a defensive weapon, which causes intense pain to characters approaching too close to the monarch.

**First Appearance:** INCREDIBLE HULK #349.

#### Powers:

*Neuro-Space Field:* When activated, the device emits waves of energy that totally surrounds Doctor Doom. All characters within 2 areas of Von Doom are subjected

to intense pain and must attempt an Incredible (40) Intensity Psyche FEAT roll. Those who succeed overcome the pain but perform all FEATs while in the field at -2CS. Characters who fail the Psyche FEAT are stunned for 1-10 turns. At the end of this time, a stunned character may attempt another Psyche FEAT with the same results for success or failure. The pain immediately ceases if the character is moved more than 2 areas away from Doom, or if the device is deactivated.

**Material Strength:** Good (10).

**Tech Rank:** Shift Z (500).

**Availability:** Doom keeps one of these weapons in his laboratory at Castle Doom, where technicians can add it to his armor upon command.

### Neutro-Chamber

This cage is designed to reduce a character's natural abilities and powers, weakening him and preventing him from escaping. A neutro-chamber looks like a rectangular glass and steel reinforced tank, just large enough for a tall character to stand comfortably. A separate panel controls the cage's functions.

**First Appearance:** FANTASTIC FOUR #143.

#### Powers:

*Power Dampening Gas:* An invisible gas within the cage lowers all of the character's physical statistics (Fighting, Agility, Strength, and Endurance) by -5CS after two rounds. Additionally, a character's power ranks are reduced by -7CS. No ability or power rank may drop below Feeble (2). Talents, mental abilities (not mental powers), and technological and magical powers remain unaffected. The control panel can be used to remove the gas and to open the cage.

**Material Strength:** Excellent (20) (neutro-chamber); Good (10) (control panel).





**Tech Rank:** Monstrous (75).

**Availability:** Doctor Doom has four neutro-chambers in a hidden complex beneath the streets of New York City. It is very likely that others could be found in Castle Doom in Latveria and the Fortress of Doom in the Adirondack Mountains of New York.

## Omni-Missile

Omni-missiles are Doctor Doom's high-tech response to heavily-armed invaders. Nearly all of his strongholds around the world are protected by these weapons, which can hit targets both in the air and on the ground. Omni-missiles vary widely in size and shape, but they never exceed 10' in length or 3' in diameter.

The weapon consists of four separate pieces of equipment—a missile launcher, the payload, a control system, and the missile itself.

**First Appearance:** SUPER-VILLAIN TEAM-UP #6.

### Statistics:

Control:	INCREDIBLE (40)
Speed:	REMARKABLE (30)
Body:	EXCELLENT (20)

### Powers:

**Energy Tracking System:** The missile can track a target emitting any type of energy—heat, light, radiation, radio waves, sound, kinetic energy (motion), plasma, electricity, and so on. Because an omni-missile can track all types of energy at once, it is virtually impossible to fool.

Even so, a flying target can always try to dodge an incoming missile. Any resulting column shifts as a result of the dodge are applied to the missile's Control FEAT roll when it attempts to hit the target. If it misses, the missile flies past the target and can turn around and attack again during the next round of combat.

**Payload:** Omni-missiles can be fitted with a variety of different payloads:

- **Standard shrapnel:** Inflicts Incredible (40) edged damage to everything in the target area.

- **Concentrated Explosive:** Inflicts Incredible (40) edged damage to the target only.
- **High Explosive:** Causes Monstrous (75) edged damage to everything in the target area, and Excellent (20) edged damage in adjacent areas.
- **Incendiary:** Inflicts Incredible (40) energy damage to everything in the target area, and burns with Good (10) Intensity each round thereafter until extinguished.
- **Knock-Out Gas:** All targets in the area of impact must attempt a Remarkable (30) Intensity Endurance FEAT roll. Those who fail fall asleep for 1-10 turns.
- **Smoke:** Excellent (20) Intensity smoke prohibits vision and all FEATs in the area are at -2CS.
- **Tear Gas:** All targets in the area of impact must attempt a Typical (6) Intensity Endurance FEAT roll. Those who fail cannot see and must leave the area for 1-10 rounds to clear their eyesight.

**Material Strength:** Excellent (20) (any omni-missile); Good (10) (launcher); Typical (6) (control system).

**Tech Rank:** Unearthly (100).

**Availability:** Castle Doom is protected by 20 omni-missiles, each fitted with any type of payload described above. The Latverian Embassy even has one in a hidden silo under its rear courtyard.

## Pacifier Robot

Like the majority of Doom's robots, the pacifier is made to look like a hulking humanoid. Red, metal plates cover its large body. Its head consists of various lenses, tubes, and other metallic projections. Its left hand ends in three powerful fingers, while fixed to the right is an apparatus consisting of five gun barrels, each capable of firing a different weapon.

**First Appearance:** FANTASTIC FOUR #57.

### Statistics:

Fighting:	REMARKABLE (30)
Agility:	EXCELLENT (20)
Strength:	REMARKABLE (30)
Endurance:	REMARKABLE (30)
Reason:	POOR (4)
Intuition:	POOR (4)
Psyche:	POOR (4)
Health:	110
Karma:	N/A

### Powers:

**Body Armor:** The pacifier is made of Incredible (40) strength materials, granting it Incredible (40) protection from both physical and energy attacks.

**Energy Blaster:** The pacifier can shoot a bolt of Remarkable (30) rank energy up to 8 areas away from its forehead mounted blaster.

**Remote Control:** The robot's actions can be controlled with a hand-held device. The controller must be within Good (10) range (4 areas) of the pacifier; the robot shuts down if its control moves further away.

**Robotic Form:** The pacifier robot cannot be affected by mental or emotional attacks or by illusions. It can be harmed by powers that affect machinery, however.

**Weapons Gauntlet:** The pacifier's right hand is fitted with a gauntlet containing five gun barrels. Only one weapon may be fired per round. Use the pacifier's Agility to determine hits with the following results:

- **Adhesive Spray:** The pacifier can shoot a stream of a gray, sticky substance up to 2 areas away at a single target. If hit, the victim is held in place by Remarkable (30) material strength adhesive. It evaporates after 10-50 (5d10) turns. The robot carries enough adhesive for 10 shots.
- **Flamethrower:** It can expel a burning stream of jelled fuel up to a range of 1 area onto one target. If struck, the victim suffers Incredible (40) flame and heat energy damage. The pacifier has enough fuel for five shots.
- **Laser:** Within a Good (10) range (4 areas), the pacifier's laser inflicts Good (10) energy damage. The laser can be fired 20 times before its energy cell must be recharged.

- **Machine Gun:** This weapon is effective up to Excellent (20) range (6 areas), and inflicts Good (10) Shooting damage on a successful hit. The robot carries 100 rounds of ammunition.
- **Stun Gun:** With a Remarkable (30) range of up to 8 areas, the stun gun renders its victim unconscious for 1-10 turns. Targets can try to succeed at a Remarkable (30) Intensity Endurance FEAT to resist the stun effect. This can be fired 20 times before it needs recharging.

**Limitation:** Doctor Doom can trigger a self-destruct mechanism on the robot by a button in his armor at a maximum range of 20 areas.

**Talents:** None.

**Role-Playing Notes:** The pacifier robot is a killing machine with no personality of its own. If controlled remotely, consider the personality of the controller to determine how the pacifier responds to situations.

**Material Strength:** Remarkable (30).

**Tech Rank:** Unearthly (100).

**Availability:** Doctor Doom built only one pacifier robot, which was never put into action. It now stands motionless within the depths of Castle Doom.

### Particle Projector

Doctor Doom created this huge machine in order to eliminate all of the world's nuclear weapons. It looms 30' tall, and takes the shape of a metal cylinder fitted with numerous pipes, cables, blinking lights, and other machinery. When activated, it emits a huge stream of glowing particles into Earth's atmosphere, which neutralize radioactive isotopes and other materials.

**First Appearance:** CLOAK & DAGGER (Vol. 2) #10.





**Powers:**

*Nuclear Dampener:* When the machine is activated, its neutralization particles are sprayed into Earth's upper atmosphere. It takes them one full day to spread around the entire globe, during which time the machine must continue to operate or the procedure fails. Thus by switching off the particle projector before a day has passed, the effects can be stopped.

Upon contacting the particles dispersed by this machine, any type of radioactive material is immediately neutralized, becoming totally inert. This includes materials used in nuclear weapons, as well as radioactive isotopes used in industry, medicine, and science in general.

The neutralization particles have Unearthly (100) rank Phasing power. This means they can pass right through virtually any force field or other device used to contain radioactive materials.

**Limitation:** For the process to be successful, very specific atmospheric conditions must be present. Such conditions have only a 10% chance of occurring for one day of every year. Thus, it may be years before the projector can successfully be put to use.

**Material Strength:** Incredible (40).

**Tech Rank:** Shift Y (200).

**Availability:** Doctor Doom has a complex system of weather satellites to accurately predict the day on which he can put his particle projector to work. His first attempt was foiled by Cloak and Dagger, and Doom was tricked into destroying his own machine with an energy blast. Whether Doom will rebuild the particle projector remains to be seen.



**Plasteel Sphere**

This device was made specifically as a prison for Mister Fantastic. It consists of a short metal stand and a separate control panel. The captive is placed on the metal stand, and the control panel is activated. A transparent bubble of plasteel forms upon the metal stand, completely surrounding the captive.

**First Appearance:** FANTASTIC FOUR #288.

**Powers:**

*Bubble Creation:* The plasteel sphere is porous enough to allow air to pass through it, but has no seams and is not porous enough to allow Mister Fantastic's pliable form to exit. Physically breaking out requires a successful Incredible (40) Intensity Strength FEAT roll. The control panel can be used to deactivate the cage, causing the bubble to "pop" and release the captive unharmed.

**Material Strength:** Incredible (40) (plasteel bubble); Good (10) (control panel).

**Tech Rank:** Monstrous (75).

**Availability:** One plasteel sphere machine is kept in Doctor Doom's secret laboratory beneath the Latverian Embassy in New York City. Another working model also exists within Castle Doom.

**Plasti-Gun**

This unusual device looks like an exotic handgun. When "fired," it creates a barrier made of a unique type of damage-resistant plastic. It is not an offensive weapon, but is designed to allow Doctor Doom to elude pursuers or trap opponents.

**First Appearance:** DAREDEVIL #37.

**Powers:**

*Plastic Generation:* The plasti-gun emits a thin beam of energy up to 3 areas away. At any designated point

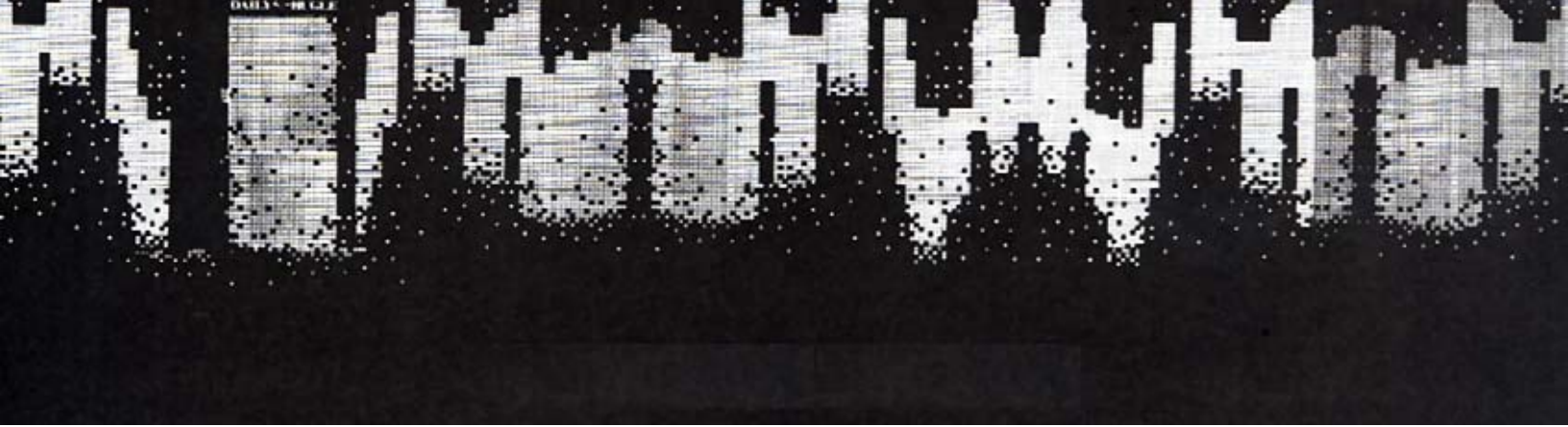

within this range, the beam instantly creates a wall of plastic measuring up to 10' wide by 10' tall by 1' thick. The wall falls over unless supported between two objects (a pair of street lamps, trees, or the walls of a room, for example). The wall conforms to virtually any shape. If created in a round tunnel, for instance, the wall would be round, and would completely seal off the tunnel. The plastic wall is opaque to normal vision and has Excellent (20) material strength. Thus, breaking through it requires a successful Excellent (20) Intensity Strength FEAT.

**Material Strength:** Good (10) (plasti-gun), Excellent (20) (plastic wall).

**Tech Rank:** Unearthly (100).

**Availability:** Doctor Doom once used this device to prevent a crowd of spectators from following him after he had captured Daredevil. He has never employed this invention since then, and it is unlikely that he has more than one available.

## Power Dampener

The power dampener is a metal helmet designed to nullify a character's mental powers.

**First Appearance:** FANTASTIC FOUR #197.

### Powers:

*Psionic Dampening:* When placed on a subject's head, the power dampener lowers the character's mental and psionic powers by -7CS. Such powers cannot be reduced to less than Feeble (2) rank. A hero with a normal Incredible (40) rank telekinesis has only Feeble (2) telekinesis while wearing the helmet.

**Material Strength:** Excellent (20).

**Tech Rank:** Unearthly (100).

**Availability:** Doctor Doom has one power dampener at his castle in Latveria, which he has used in the past to neutralize the Invisible Woman's powers.

## Power Sphere

A power sphere is a glowing orb about the size of a tennis ball. They are typically used as a defense system, being released from a hidden compartment in the wall or ceiling to hurtle down a passage or through a chamber. The spheres are attracted by heat, and fly toward their target in a swarm. When the victim is completely encased, the power spheres erupt with energy, transporting the entrapped target to another dimension.

**First Appearance:** FANTASTIC FOUR #17.

### Powers:

*Dimensional Travel:* Once the spheres have surrounded their victim, they burst and form a Remarkable (30) rank energy field that has the power to transport the victim to another dimension. There must be at least 50 orbs in the swarm covering a human-sized target for their detonation to effectively transport it to another dimension.

If the FEAT fails, the accumulated orbs erupt with a brilliant flash of light, but otherwise have no effect. If the roll is successful, the character finds himself in a distant universe of the Judge's choosing. In either case, the power spheres are destroyed.

*Flight:* The orbs fly at Remarkable (30) airspeed (15 areas per turn).

*Heat Seeking Missile:* The power spheres fix onto the hottest heat source in their path (a flaming hero before a normal character, for example). Once locked on, they can be sidetracked by a stronger heat sources and will even pursue non-living objects.

**Material Strength:** Good (10).

**Tech Rank:** Unearthly (100) (per swarm of 100).

**Availability:** Power spheres can be found as a trap or defense system in virtually any of Doctor Doom's strongholds.





## Power Transference Machine

This large device is a combination of two separate machines. The first is a huge metal apparatus with four large, plastic spheres radiating from its center by metal support spokes. The other machine consists of a specially wired chair with a receiving dish for power from the first machine. Up to four superhuman subjects are placed inside the plastic spheres with the person receiving their powers strapped into the chair. When the process is successfully completed, the subjects in the spheres are powerless—all of their powers have been transferred to the person in the chair!

**First Appearance:** FANTASTIC FOUR #198.

### Powers:

*Power Transference:* The transfer takes 10 rounds to complete. At the end of this time, a successful Amazing (50) Intensity Endurance FEAT roll allows victims to retain their powers. For those who fail, make an Amazing (50) FEAT roll for the machine:

- *White:* A system failure interrupts the process, and the powers are not transferred.
- *Green:* The victim's powers are transferred to the recipient, but at a power rank of -5CS from the original. The victim's powers are erased.
- *Yellow:* The victim's powers are transferred to the recipient, but at a power rank of -3CS from the original. The victim's powers are erased.
- *Red:* The victim's powers are transferred to the recipient at their original power rank. The victim's powers are erased.

Breaking out of a plastic sphere requires a successful Good (10) Intensity Strength FEAT. If the victim should escape from the plastic sphere before the process is complete, attempt an Amazing (50) power rank FEAT for the device:

- *White:* The victim retains his powers, which are not transferred to the recipient.
- *Green:* The recipient gains the victim's powers at -5CS power rank. Even so, the victim retains his powers at full strength.

- *Yellow:* The recipient gains the victim's powers at -3CS power rank. Even so, the victim retains his powers at full strength.
- *Red:* The recipient gains the victim's powers at their original power rank. Even so, the victim retains his powers at full strength. Thus, both characters have the same powers.

**Material Strength:** Good (10) (transfer spheres, control panel); Excellent (20) (chair, transfer machinery).

**Tech Rank:** Unearthly (100).

**Availability:** Doctor Doom has one working model of this machine within Castle Doom. It was used to transfer the Fantastic Four's powers to his "son" (See Victor Von Doom II in the Domains of Doom book).

## Psionic Refractor

This small, hand-held device consists of a metal handle with a small hexagonal metal frame at the top. When activated, a white force field fills the metal frame.

**First Appearance:** FANTASTIC FOUR #116.

### Powers:

*Psionic Refraction/Reflection:* The psionic refractor can deflect mental force bolts of up to Amazing (50) rank. Whenever the wielder of this device is attacked with mental force (and the attacker's roll indicates a hit), the wielder may attempt a FEAT roll on the Amazing (50) power rank Column of the Universal Table:

- *White:* The mental force bolt passes through the psionic refractor, destroying it, and strikes the wielder at -3CS Intensity. (If the bolt was originally of Remarkable (30) rank, for example, it is now only of Typical (6) Intensity.)
- *Green:* The mental force bolt is reflected in a random direction, striking a target up to 3 areas away at -3CS Intensity. The psionic refractor is unharmed and may be used again.

- **Yellow:** The bolt is reflected back at its creator at -3CS Intensity. The wielder of the psionic refractor must succeed at an Agility FEAT to hit the target, effects checked on the Force Column. The refractor is unharmed and may be reused.
- **Red:** The mental force bolt is reflected back at its creator with full effect. The wielder of the psionic refractor must succeed at an Agility FEAT to hit the target, effects checked on the Force Column. The psionic refractor is unharmed and may be used again.

The psionic refractor can only reflect one attack at a time, but it can reflect any number of attacks over the course of a combat round. If two or more attacks strike the wielder simultaneously, he must decide which single attack he will attempt to reflect.

A psionic refractor is only effective against mental force bolts that must be of Amazing (50) rank or less. Bolts of greater rank automatically have the effect of a White result, as described above.

**Material Strength:** Good (10).

**Tech Rank:** Shift X (150).

**Availability:** The original psionic refractor was destroyed in a battle with the Over-Mind, in which Doctor Doom allied himself with the Fantastic Four for a short time. As Dr. Doom built this device from a prototype Reed Richards had started, it is unlikely that Doom has other models at his disposal. Reed however, has the remains of the original refractor and his own plans; it is unknown whether he has a working model, but it is possible, given all his ever-running experiments.



## Psycho-Prism

The psycho-prism was a glass crystal fixed atop a tall metal cylinder, the prism measuring 10' across. It was powered by Zebediah Killgrave, the Purple Man. Using and amplifying the Purple Man's power through the prism, Dr. Doom gained the power to control the world!

**First Appearance:** Emperor Doom (Graphic Novel #26).

### Powers:

**Mind Control:** When the prism is activated, energy corruscates from it in waves, spreading into the upper atmosphere. Within one day, the energy spreads across the entire planet.

Characters are allowed to attempt an Amazing (50) Intensity Psyche FEAT rolls upon first contact with the invisible energy wave. Those who succeed are unaffected by the psycho-prism's control. Those who fail become totally loyal to the machine's controller (in this case, Dr. Doom). If the character is ordered to do something against his nature, or to commit acts that would result in a Karma loss, he may attempt another Amazing (50) Intensity Psyche FEAT to resist.

**Limitation:** The device cannot directly affect robots, androids, or other synthetic beings. The power of the Purple Man is also partially dependent on airborne pheromones or other substances which are inhaled and absorbed through the skin. Therefore, it cannot affect organisms that do not breathe oxygen.

**Material Strength:** Remarkable (30).

**Tech Rank:** Shift X (150).

**Availability:** The original psycho-prism was built on a small Caribbean island owned by Doctor Doom. It was destroyed by the Sub-Mariner and the Avengers, and the Purple Man was killed in the blast. The only way to utilize this equipment is to kidnap and use Kara Killgrave, the Purple Man's daughter, (AKA Persuasion of Beta Flight) as a living mind-control projector. Currently, the prism and all its attendant machinery lies broken and dormant on the island.





## Rainbow Missile

This advanced weapon consists of four separate pieces of equipment—a missile launcher, the missile payload, a control system, and the missile itself. The missile is not especially large, measuring about five feet long and one foot in diameter. It is most commonly used as a surface-to-air missile with the purpose of eliminating enemy aircraft and flying superhumans.

**First Appearance:** SUPER-VILLAIN TEAM-UP #10.

### Statistics:

Control: INCREDIBLE (40)  
Speed: AMAZING (50)  
Body: EXCELLENT (20)

### Powers:

*Shrink Blast:* When the missile strikes its target, it explodes with a brief flash that glows with all colors of the rainbow. The target appears to vanish, but has actually been shrunk to mere inches in size.

If the target is a vessel, it and all passengers are shrunk. Characters shrink to a size of three inches, while their equipment and vehicles shrink proportionately. All physical abilities (Fighting, Agility, Strength, and Endurance) and power ranks are reduced by -6CS to a minimum of Feeble (2). This means a character's Health is also reduced. The material strength of objects is not reduced—Captain America's shield is still made of Class 3000 material no matter what size it is! Shrunk characters gain a +1CS to hit human-sized opponents, and are at a -1CS to be hit by human-sized foes.

The effects of the rainbow missile are permanent. However, the missile's control system can be used to restore characters and objects to their normal size by simply pressing a button. Subjects must be within 4 areas of the control system for it to help them.

*Tele-Guidance:* The missile is guided by a camera in its nose, which relays a video image to the control system console. Maximum range for viewing and control is five miles. Use the Control of the missile or the Agility of the controller (whichever is lower) to determine Control FEATs for this weapon.

**Material Strength:** Excellent (20) (missile); Good (10) (launcher); Typical (6) (control system).

**Tech Rank:** Unearthly (100).

**Availability:** In addition to its other defenses, Castle Doom is protected by at least one rainbow missile.

## Reducing Ray

The reducing ray looks like a large immobile metal beam weapon attached to a computer console by thick cables.

**First Appearance:** FANTASTIC FOUR #10.

### Powers:

*Shrinking Ray:* Characters hit by the Shift X (150) rank reducing ray suffer no damage, but are reduced in size to the point where they vanish from the Earth dimension and reappear in the Microverse, a universe similar to our own. The transition from human-size or larger to the arrival into the Microverse takes about two rounds. Shrunk characters retain their attributes and powers in the Microverse.

The effects of the reducing ray are permanent. However, Doctor Doom built an enlarger ray during his stay in the Microverse, which still remains there. If characters can locate it, they could use it to return to their own dimension.

**Material Strength:** Excellent (20).

**Tech Rank:** Shift X (150).

**Availability:** After using his mind transferral power upon Reed Richards, Doctor Doom built this device in the Baxter Building. Doom (as Reed Richards) failed to use the ray on the rest of the Fantastic Four and he was returned to his real body before he could use the weapon. During the scuffle, Doom was accidentally hit by the ray and shrank to nothingness. Presumably, Doctor Doom's only functional reducing ray is still in the possession of the Fantastic Four.

## Refrigeration Unit

This small device can be added to either gauntlet of Doctor Doom's armor. It has the potential to freeze a character in a solid block of ice!

**First Appearance:** FANTASTIC FOUR #23.

### Powers:

*Ice Generation:* To activate this power, Doctor Doom must touch his opponent by succeeding at a Fighting FEAT roll. If successful, the target is completely encased in a block of ice. Breaking free requires a successful Remarkable (30) Intensity Strength FEAT. Given time, the ice will melt like ordinary ice.

**Material Strength:** Good (10).

**Tech Rank:** Shift Y (200).

**Availability:** Doctor Doom has two of these at his disposal in his personal laboratory in Castle Doom.

## Ring Imperial

This ring is one of the Crown Jewels of Latveria. It is studded with glorious gemstones and bears the royal crest of Latveria. The ring can be used as a defensive weapon. When activated, the ring emits invisible waves of energy that cause intense pain in anyone near the wearer. When functioning, the ring glows brilliantly.

**First Appearance:** DAREDEVIL #38.

### Powers:

*Pain Generation:* When this system is activated, all characters in the same area as the ring must attempt a Remarkable (30) Intensity Psyche FEAT roll. Those who fail can do nothing but writhe on the ground in intense agony. Those who succeed act at a -3CS penalty to all FEAT rolls due to the pain. Psyche FEATs must be attempted each round. The ring has enough energy to function for 10 consecutive rounds.

**Material Strength:** Remarkable (30).

**Tech Rank:** Shift X (150).

**Availability:** Only one Ring Imperial exists. It is worn solely by Victor Von Doom; when not worn, it is locked in his private vault with the other Crown Jewels.

## Robotron

This robot is humanoid in shape, looking much like a man in a battle suit. Each of a Robotron's arms ends in an energy blaster. This robot is used mostly as a sentry.

**First Appearance:** DAZZLER #4.

### Statistics:

Fighting:	GOOD (10)
Agility:	GOOD (10)
Strength:	EXCELLENT (20)
Endurance:	EXCELLENT (20)
Reason:	POOR (4)
Intuition:	POOR (4)
Psyche:	POOR (4)
Health:	60
Karma:	N/A

### Powers:

*Body Armor:* Robotrons are made of Good (10) strength materials, and have Good (10) body armor vs. physical and energy attacks as a result.

*Energy Blaster:* Each of the robotron's arms is equipped with one of these weapons. A blaster has a range of 4 areas and inflicts Remarkable (30) energy damage.

*Robotic Form:* Robotrons cannot be affected by mental or emotional attacks or illusions. They can be harmed by powers that affect machinery, however.

**Talents:** None.

**Role-Playing Notes:** A robotron is an emotionless, sentry robot, programmed to guard prisoners or locations and prevent escape or entry.

**Material Strength:** Good (10).





**Tech Rank:** Amazing (50).

**Availability:** Robotrons are often positioned outside important chambers in virtually all of Doctor-Doom's bases around the world outside of Latveria—with orders to shoot intruders on sight.

### Saucer-Ship

This futuristic vessel looks like a gold and silver flying saucer with a dorsal fin and two stunted wings. It contains two small decks. The upper deck is the master control room, while the lower is a large cargo hold.

**First Appearance:** FANTASTIC FOUR #246.

#### Statistics:

Control:	REMARKABLE (30)
Air Speed:	SHIFT Z (500)
Space Speed:	CLASS 1000 (1000)
Body:	EXCELLENT (20)

#### Powers:

*Flight:* The saucer-ship can fly through the Earth's atmosphere at Shift Z speed (200 areas per turn). Through space, it can travel at Class 1000 speed (near interplanetary speed).

*Laser Cannons:* Three laser cannons can be fired in any direction outside the ship up to a range of 40 areas and inflict Monstrous (75) energy damage.

*Non-Detectability:* The ship is shielded against nearly all detection devices at Remarkable (30) rank. It cannot be seen by means of visible, infrared, or ultraviolet light, radio waves, conventional radar or sonar, or hard radiation emissions. Its engines run quietly, and cannot be heard by normal ears.

*V.T.O.L. Capability:* The vessel can land and take off vertically with Remarkable (30) ability. It can also hover in place for extended periods of time.

**Material Strength:** Excellent (20).

**Tech Rank:** Class 3000.

**Availability:** Doctor Doom owns one saucer-ship, which is kept in a hidden hangar beneath the courtyard of the Latverian Embassy in New York City. Its "stealth" abilities allow him to travel undetected between his castle in Europe and the embassy in America.

### Seeker

This scaly, green-skinned creature is an android created by Doctor Doom. Both of its powerful arms end in three short metal rods. Its mouth is filled with a metal grid, and a mechanical "eye" is fixed to the top of its head.

**First Appearance:** FANTASTIC FOUR #144.

#### Statistics:

Fighting:	GOOD (10)
Agility:	GOOD (10)
Strength:	REMARKABLE (30)
Endurance:	REMARKABLE (30)
Reason:	POOR (4)
Intuition:	POOR (4)
Psyche:	POOR (4)
Health:	80
Karma:	12

#### Powers:

*Body Armor:* Seeker gains Good (10) protection from physical and energy attacks.

*Nuclear Discharger Prods:* Both of the android's arms end in these weapons, which discharge Incredible (40) Intensity energy. The prods have no range and are only useful in slugfest combat. Consider a bull's-eye result to be a stun instead.

*Robotic Form:* Seeker cannot be affected by mental or emotional attacks or illusions. It can be harmed by powers that affect machinery, however.

*Vibro-Sensor:* The electronic eye fixed to the Seeker's forehead allows it to track the bodily vibrations and resonances (heartbeat, brain waves, etc.) of its target. The android must be within Amazing (50) range (20 areas) of its prey for the vibro-sensor to function. Note that the vibro-sensor can detect invisible or hidden characters.

**Talents:** None.

**Role-Playing Notes:** The seeker android is a hunter-killer with little personality or reason. It hunts its quarry mercilessly, and never retreats from battle.

**Material Strength:** Good (10).

**Tech Rank:** Monstrous (75).

**Availability:** Doctor Doom built only one seeker android, which was swiftly beaten and reprogrammed by the Fantastic Four. It has been left abandoned in one of Doom's New York bases, long since deactivated.

## Silent Stalker

This strange robot stands on four spindly wheeled legs. Four metal arms rise from its cylindrical torso to support a crystalline device, which acts as its brain. The robot is designed to locate and terminate specific individuals.

**First Appearance:** THOR #183.

### Statistics:

Fighting:	POOR (4)
Agility:	EXCELLENT (20)
Strength:	POOR (4)
Endurance:	REMARKABLE (30)
Reason:	GOOD (10)
Intuition:	POOR (4)
Psyche:	POOR (4)
Health:	58
Karma:	N/A

### Powers:

**Blasters, Energy or Stunners:** Six beam weapons are spaced evenly around the stalker's torso. Each blaster can fire an energy or stunning attack of the robot's choice. Range for both types is 11 areas. Energy blasts inflict Incredible (40) damage on a hit. Stunning blasts are of Incredible (40) Intensity also. A target must succeed at an Incredible (40) Intensity Endurance FEAT or pass out for 1-10 turns.

Because the stalker can spin in place like a top, all six blasters can be fired at the same target in a single round. Each shot after the first has a cumulative -1CS penalty to hit.

**Body Armor:** The silent stalker gains Good (10) protection from physical and energy attacks.

**Enhanced Senses:** The stalker's Remarkable (30) rank senses are used rather than its Intuition when looking for clues, or spotting items and characters.

**Infrared Visual Enhancement/"Night Vision":** The robot can see up to 5 areas away in total darkness, and suffers no penalties for fighting in the dark.

**Lightning Speed:** The stalker can roll along the ground at up to Remarkable (30) land speed (6 areas per turn). It can turn without difficulty at top speed, and can accelerate to top speed and stop in a single round.

**Stalking:** When a photograph of a character is placed inside the stalker's torso, the robot tirelessly hunts down that person. When it comes into contact with its target, the robot either terminates or subdues the victim according to its programming.

**Talents:** None.

**Role-Playing Notes:** The silent stalker hunts its quarry mercilessly, but has no programming for personality.

**Material Strength:** Good (10).

**Tech Rank:** Monstrous (75).

**Availability:** Doctor Doom built one silent stalker, which was sent after Doctor Donald Blake (alias Thor). It did not succeed, and is presumably still part of Doom's arsenal in Latveria.

## Sonic Drill

This gadget can be inserted into the palm of Doctor Doom's armored gauntlet. It emits a powerful beam which silently drills through matter, such as dirt or rock.

**First Appearance:** SUPER-VILLAIN TEAM-UP #2.



**Powers:**

*Sonic Drill:* The Incredible (40) beam has a range of 1 area, and forms a tunnel 10' in diameter by disrupting matter of up to Incredible (40) material strength. A passage 1 area long can be made each turn.

**Material Strength:** Good (10).

**Tech Rank:** Shift Z (500).

**Availability:** Doctor Doom has one sonic drill which is kept in his laboratory in Castle Doom.

## Spider-Finder

This small hand-held gadget receives impulses given off by spiders. Spider-Man gives off very strong and distinct impulses, and this device is effective at tracking him.

**First Appearance:** AMAZING SPIDER-MAN #5.

**Powers:**

*Spider-Detection:* The device can track spiders and beings associated with spiders at Shift Y (200) range. It tracks down the strongest impulses within range.

**Material Strength:** Typical (6).

**Tech Rank:** Shift Y (200).

**Availability:** See Spider-Wave Transmitter below.

## Spider-Wave Transmitter

This is a communication device which employs a captured spider and assorted machinery to emit impulses that can be heard by Spider-Man.

**First Appearance:** AMAZING SPIDER-MAN #5.

**Powers:**

*Spider-Transmission:* The impulse has a range of 5 miles, and can only be heard by beings closely tied with spiders, like Spider-Man. Such characters can easily trace the impulse to its point of origin.

**Material Strength:** Poor (4).

**Tech Rank:** Shift Y (200).

**Availability:** Doctor Doom created these spider-related devices in a hidden laboratory within New York City, where they presumably have lain unused for years.

## Stasis Gun

Looking like a short, metal rifle with a forked barrel, this weapon encases its target within a super-hard energy shell. It purportedly has the power to stop even the rampaging Hulk.

**First Appearance:** SUPER-VILLAIN TEAM-UP #3.

**Powers:**

*Stasis Shell:* When fired, the weapon emits a stream of energy up to a range of 1 area. Roll against the shooter's Agility and check results on the Force Column. If the target is hit, he is caught in the stream and surrounded by the energy. At this point, the stasis shell has Incredible (40) Strength.

If the stream is maintained for one full round, the stasis shell solidifies, gaining a permanent Strength of Unearthly (100). If the stream is interrupted or halted before one round has passed, the energy shell does not solidify and immediately dissipates.

Victims "freeze" in place, and have no need of nourishment or air. Nearly all bodily functions are suspended. They can, however, see, hear, smell, and feel what is happening around them. A victim can make a single attempt to break free the first round in stasis. If the shell has solidified, this requires an Unearthly (100) force attack or Strength FEAT. The stasis shell is permanent until destroyed, either by reversing the gun's polarity and draining the shell, or by some other more-powerful means. The stasis gun can be fired once per round, and can fire 10 times before needing a recharge.

**Material Strength:** Excellent (20) (gun).

**Tech Rank:** Shift Y (200).

**Availability:** The original stasis gun was destroyed by the Sub-Mariner. It is certainly likely that other stasis guns are kept within the armories of Castle Doom.

### Stun-Shocker

This small weapon, meant to knock opponents unconscious, can be added to the inside of either gauntlet of Doom's armor.

**First Appearance:** SUPER-VILLAIN TEAM-UP #3.

#### Powers:

*Stun-Shock Pulse:* This device radiates stunning energy around Doctor Doom. All characters within the same area must make an Amazing (50) Intensity Endurance FEAT or be knocked out for 1-10 rounds.

**Material Strength:** Typical (6).

**Tech Rank:** Class 1000.

**Availability:** Doom has only one of these devices; when not in use, it is stored in Castle Doom.

### Swarmbots

Swarmbots are small multi-purpose robots built in a variety of small, beetle-like shapes. Although not individually powerful, Doom designed them to attack in a huge swarm to keep foes occupied and confused.

**First Appearance:** FANTASTIC FOUR ANNUAL #20.

#### Statistics:

Fighting: POOR (4)  
Agility: GOOD (10)  
Strength: POOR (4)  
Endurance: TYPICAL (6)  
Reason: POOR (4)  
Intuition: POOR (4)  
Psyche: POOR (4)  
Health: 24  
Karma: 12

#### Powers:

*Body Armor:* Swarmbots are made of Typical (6) strength materials and have Typical (6) rank body armor.

*Flight:* Swarmbots can fly by leg-mounted rockets at Typical (6) airspeed (6 areas per turn).

*Force Blasts:* Each swarmbot is armed with a Good (10) Intensity force blast with a range of 4 areas.

*Robotic Form:* Swarmbots cannot be affected by mental or emotional attacks or illusions. They can be harmed by powers that affect machinery, however.

*Self-Assembly & Integration:* A swarmbot can combine itself with two other swarmbots to form a single integrated robot (powers & attributes enhanced +3CS above normal) in two rounds.

**Talents:** None.

**Role-Playing Notes:** Swarmbots have simple personalities with artificial speech and memory cores to record and receive information. All swarmbots can respond to various commands (from programs to verbal commands to various pitches designed to override programming and ready it for new orders).

**Material Strength:** Typical (6).

**Tech Rank:** Monstrous (75).

**Availability:** Doctor Doom has over 100 of these small robots readied and stored in his Adirondacks castle.





**Thermo-Lance**

This device consists of a heavy insulated metal rod attached by cables to a large generator.

**First Appearance:** FANTASTIC FOUR #350.

**Powers:**

*Energy Generation:* The thermo-lance can channel over "a million megavolts of energy" into its victim, causing Shift X (150) energy damage. The target must succeed at a Shift X (150) Intensity Endurance FEAT or fall unconscious for 1-10 turns. Attached to an immobile machine, the lance can only be used on victims within the same area.

**Material Strength:** Excellent (20).

**Tech Rank:** Amazing (50).

**Availability:** The only known thermo-lance is found in a laboratory within Castle Doom.

**Time-Bot**

Constructed of glittering red metal, the time-bot is mighty to behold. Its head looks like a medieval knight's pot helm, with dispassionate eyes shining within. It can fire a ray capable of sending targets back in time.

**First Appearance:** THOR #409.

**Statistics:**

Fighting:	EXCELLENT (20)
Agility:	EXCELLENT (20)
Strength:	INCREDIBLE (40)
Endurance:	INCREDIBLE (40)
Reason:	GOOD (10)
Intuition:	POOR (4)
Psyche:	POOR (4)
Health:	120
Karma:	N/A

**Powers:**

*Body Armor:* The time-bot is fashioned from Remarkable (30) strength materials, gaining Remarkable (30) rank body armor as a result.

*Flight:* From jets in its boots, the robot can fly at Remarkable (30) airspeed (15 areas per round).

*Force Field:* The time-bots personal force field gives it Unearthly (100) protection from all types of attacks. It cannot maintain a force field while using its weapons.

*Time Ray:* This Incredible (40) rank energy beam has a range of up to 11 areas away. It sends its target back in time to Earth's Mesozoic Era. After 1-10 turns, the victim suddenly reappears at the point where he was struck by the ray. Inanimate objects struck by the beam are also automatically affected. The robot can either send such objects back in time for 1-10 turns, or confine them in the time stream. Confined items can be returned to the present by the robot at a later time, often when commanded to do so by Dr. Doom.

**Talents:** None.

**Role-Playing Notes:** The time-bot is an efficient and emotionless servant. It does not speak, only carrying out its orders with mindless grim determination.

**Material Strength:** Remarkable (30).

**Tech Rank:** Unearthly (100).

**Availability:** Doctor Doom built one time-bot, which was recently destroyed in battle with the mighty Thor.

### Time Displacer

Doctor Doom created this machine after being displaced as Latveria's monarch. It looks like a human-sized steel vice covered with circuitry and blinking lights. It requires the energy from mystic artifacts of awesome power (such as Mjolnir, Thor's hammer) to function. Once activated, it has the power to hold entire towns in stasis.

**First Appearance:** THOR #410.

**Powers:**

*Time Displacement:* The machine emits an invisible force which can be directed against an area as large as two square miles. The device must be placed within 5 miles to affect a certain area. Everything in the affected region comes to an immediate halt as time is suspended. Inanimate objects, as well as living creatures, are affected.

The effect persists until the machine is switched off or until its power source is removed. During this time, affected characters do not age or suffer from hunger or thirst. Such characters are at the mercy of anyone who is immune to the effect, such as Dr. Doom.

**Limitation:** The time displacer requires a source of mystical energy to function. Doctor Doom used Thor's hammer. Only an artifact of similar might will suffice.

**Material Strength:** Excellent (20).

**Tech Rank:** Shift Y (200).

**Availability:** Doctor Doom built one model of the time displacer and it was destroyed by Thor.

### Time Platform

One of Doctor Doom's most ingenious creations is a functioning time machine. It consists of a platform measuring 10' x 10' x 1/2' and a separate control console. Subjects to be sent forward or backward in time stand on the platform, while the operator stands to one side and activates the machine by means of the control console.

**First Appearance:** FANTASTIC FOUR #5.

**Powers:**

*Time Travel:* The machine can be used to instantly transport characters to virtually any time and place in Earth's timestream. The operator can instantly return the travelers by manipulating the control console. Doctor Doom does not require the console to return to his own time—he can use the time-circuitry built into his armor. Thus, he can venture into time and return on his own, without relying on someone to bring him back.





Time travel can be a tricky business. It works in the MARVEL UNIVERSE in such a way that a character traveling into the past cannot change his own past—his past continues to exist as it had before. Instead, the character causes a divergent timeline to exist, exactly parallel to the character's original timeline. Thus, the future cannot be negated by manipulating events in the past. Upon returning to his own time, the character finds his world unchanged.

As with the past, there are many alternate future timelines that a character can reach from the present. It is impossible to know which timeline will become the actual timeline of the MARVEL UNIVERSE until it becomes current history, not the future.

**Material Strength:** Excellent (platform); Good (10) (control panel).

**Tech Rank:** Unearthly (100)

**Availability:** The Fantastic Four own one of Doom's original time machines. Doom has built another which he has at his disposal in the Citadel of Doom.

### Time-Shift Bomb

This small device is the size of a baseball, appears to be made of glass, and contains swirling, multi-colored gases or energy. When thrown, it explodes on contact, shifting all targets in the blast radius two seconds into the past.

**First Appearance:** FANTASTIC FOUR #318.

#### Powers:

*Time Shift:* The bomb shifts all characters in the area where it explodes two seconds into the past for 1d10 rounds. Each character may attempt an Excellent (20) Intensity Agility FEAT roll. Those who succeed dodge the effect and are unaffected. All others in the area of effect become time-shifted for 1-10 rounds.

This device could possibly be derived from Doom's time platform technology. The grenade activates a rapidly fluctuating time platform around its area of impact and moves targets two seconds into the past.





These targets are then rapidly shuffled forward in time by increments of seconds, but they seem ephemeral to those around them due to the rapidly time shuffles and after-images.

**Material Strength:** Good (10).

**Tech Rank:** Unearthly (100).

**Availability:** Doctor Doom has used one of these in the past, and it is likely that he has others.

### Tractor Beam

These are Latveria's first line of defense. Doom is an intelligent man, and realizes that intruders can be of more value alive than dead. Thus, he employs tractor beams to capture aircraft that enter Latverian air space without permission. Should the intruder avoid the tractor beams, however.... Well, it's never been heard of happening ... or at least no one has returned to tell the tale of any such occurrences.

**First Appearance:** SUPER-VILLAIN TEAM-UP #6.

#### Powers:

*Tractor Beam:* The beams are fired from installations on the ground, and have a range of 40 areas. Crews of warrior robots shoot the weapons—use their Good (10) Agility to resolve attacks. Aerial vehicles can try to dodge the beams using Control attributes or the pilot's Agility, whichever is lowest. Flying heroes roll against their Agility as normal.

If the target is hit, it is held in a field of energy with Monstrous (75) Strength. A character can break free by succeeding at a Monstrous (75) Intensity Strength FEAT. A vehicle can escape by succeeding at a Monstrous (75) Intensity Speed FEAT, but if the vehicle's roll is a White result, its engine has burned out and is useless until repaired.

**Material Strength:** Remarkable (30) (beam projector).

**Tech Rank:** Shift X (150).

**Availability:** The borders of Latveria are protected by 50 hidden tractor beam installations, all of which are individually manned by a squad of five warrior robots (and three dormant backup robots) at all times.

### Vertigo Beam

Doctor Doom most commonly uses this device as a trap for unsuspecting heroes. The vertigo beam apparatus can be concealed in a wall, floor, or ceiling. When the trap is sprung, the invisible beam strikes the victim, causing him to lose all sense of balance and concentration. Other versions of the vertigo beam could easily be adapted, such as a hand-held model.

**First Appearance:** FANTASTIC FOUR #246.

#### Powers:

*Vertigo Beam:* A Remarkable (30) Intensity invisible beam is fired from the device up to a range of 3 areas. Using Remarkable as the beam's effective Agility, a Green result means the target has been hit. If hit, the target must attempt a Remarkable (30) Intensity Psyche FEAT. If successful, the character shakes off the effects of the vertigo beam. If the Psyche FEAT is missed, the victim cannot concentrate, loses all sense of balance, and falls to the ground for 1-5 turns. During this time the character cannot take any actions or use any powers that require even the smallest amount of concentration. (For example, the Thing's body armor and great strength do not require concentration, but he must concentrate for him to punch something—he misses hopelessly after the vertigo beam takes effect.)

**Limitation:** This device only affects organic beings, and consequently has no effect upon robots or androids.

**Material Strength:** Good (10).

**Tech Rank:** Monstrous (75).

**Availability:** Doctor Doom has one working vertigo beam in a pit trap within the Latverian Embassy in New York City; he also has plans for other models within Castle Doom.





### Vibration Machine

Knowing that Castle Doom rests on a faultline, Doctor Doom built this device as a type of self-destruct mechanism. If the castle should ever be taken, Doom can remotely activate the vibration machine, causing an earthquake that will destroy the stronghold.

**First Appearance:** ASTONISHING TALES (Vol. 1) #3.

**Powers:**

*Limited Earth Control:* Since this machine can only cause an earthquake, it has a limited form of the Earth Control power as detailed in the Basic Set rule book. The earthquake is of Monstrous (75) Intensity, and only affects Castle Doom and its surrounding two areas. Anyone caught within the castle walls during the quake suffers a Monstrous (75) edged attack from falling debris.

*Remote Control:* The machine can be activated with a hand-held device up to a Monstrous (75) distance of 40 areas.

**Material Strength:** Excellent (20).

**Tech Rank:** Unearthly (100).

**Availability:** Doctor Doom has one vibration machine set in the foundation of Castle Doom.

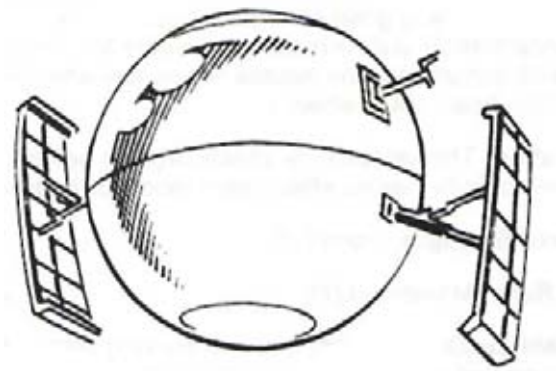

### Vibro-Bomb

This device is a metal sphere covered with electronic circuitry and blinking lights: It measures 10' in diameter. The vibro-bomb is not really a bomb, but is a strange satellite with a horrible purpose: the vibro-bomb has the power to force everyone on Earth to obey Doom's will.

**First Appearance:** FANTASTIC FOUR #144.

**Powers:**

*Vibration Ray:* When the vibro-bomb is in orbit, it sends forth energy across the surface of the planet below. Citizens across the planet are immediately affected—their eyes turn blank as their minds drain of thought, readying them for the control of Dr. Doom.

Whenever a character tries to thwart the will of Doom, he must first succeed at a Red Psyche FEAT roll before he can act independently. The effects of the ray last for as long as the vibro-bomb is operational.

*Rocket:* The vibro-bomb was originally carried into orbit in the nose of a three-stage rocket:

**Statistics:**

Control:	INCREDIBLE (40)
Air Speed:	Shift X (150)
Body:	EXCELLENT (20)

**Material Strength:** Excellent (20).

**Tech Rank:** Unearthly (100) (vibro-bomb); Monstrous (75) (rocket).

**Availability:** Doctor Doom created one vibro-bomb that was destroyed in orbit when his spaceship collided with it during a struggle with Darkoth the Death-Demon. Doom has yet to deploy another vibro-bomb, but plans still remain within Castle Doom.



### Vortex Machine

This defensive system is a feature of Castle Doom, and is designed to protect the courtyard by creating an artificial cyclone. The machine itself looks like a huge steel cannon with metal fan blades affixed to one end.

**First Appearance:** FANTASTIC FOUR #200.

**Powers:**

*Limited Wind Control—Cyclone:* The vortex machine creates a small tornado that fills 1 area. The tornado grows at the rate of 1 area wide and 2 areas high per turn, to a maximum of 6 areas in diameter and 12 areas tall. Anyone caught within the vortex suffers an Amazing (50) Intensity force attack. The winds are strong enough to move objects weighing up to 1 ton.

**Material Strength:** Good (10).

**Tech Rank:** Unearthly (100).

**Availability:** Doctor Doom has one of these devices protecting the courtyard of Castle Doom.

### Warrior Robots

These robots resemble hulking humans with purple and gray armor, but they are obviously constructs. Warrior robots are able to speak and are programmed to follow Doom's orders and to protect his various strongholds from invasion. These are Doom's most common robots.

**First Appearance:** FANTASTIC FOUR #85.

**Statistics:**

Fighting:	EXCELLENT (20)
Agility:	GOOD (10)
Strength:	GOOD (10)
Endurance:	EXCELLENT (20)
Reason:	POOR (4)
Intuition:	POOR (4)
Psyche:	POOR (4)
Health:	60
Karma:	N/A



**Powers:**

*Blaster, Energy or Force:* These robot soldiers carry blasters capable of firing Remarkable (30) Intensity beams of either force or energy. Range is 8 areas.

*Body Armor:* Warrior robots are built of Good (10) strength materials, giving them a Good (10) rank body armor.

*Computer Link:* The robots are in direct communication with Doom's various security systems in whatever area they guard. When an alarm is raised, they are always programmed to respond, other robots called in as needed. Range of the link is 10 miles.

*Exotic Weaponry:* Doom occasionally equips his troops with various high-tech weapons. Usually only one trooper in any given unit carries an individual weapon.

Options include:

- *Antimatter Extrapolator*
- *Electro-Shock Pistol*
- *Insulato-Shield*
- *Stasis Gun*
- *Stun-Shocker*

*Infrared Scope:* The blaster of one warrior robot in every squad is equipped with an infrared viewing scope, enabling the trooper to view invisible persons. The scope has Remarkable (30) rank detection.

*Robotic Form:* These soldiers are immune to mental, emotional, or illusory attacks, but can be harmed by powers that affect machinery.

**Talents:** None.

**Role-Playing Notes:** Warrior robots are devoid of any human-like personality. They follow orders with grim determination and unquestioning loyalty.

**Material Strength:** Good (10).

**Tech Rank:** Amazing (50).

**Availability:** Having over 1,000 of them built and ready at all times, warrior robots comprise the bulk of Doom's mechanical army. They patrol his strongholds and weapons installations in squads of 10, and guard more sensitive areas in specially-equipped pairs.

**XZ-12 Device**

This large machine consists of a computer console attached to three glass and steel capsules by thick cables. One subject is placed in each capsule. When the device is activated, one of the subject's inherent abilities is increased to superhuman level.

**First Appearance:** FANTASTIC FOUR #23.

**Powers:**

*Ability Enhancement/Power Endowment:* The XZ-12 machine enhances one of the subject's attributes or natural abilities to a maximum of Incredible (40) rank. The machine's operator determines exactly which attribute or ability is affected, and what the power rank will be. The device can only be used once on a character, and only to grant the character one permanent power.

The machine only enhances abilities already present in the character. For instance, it cannot grant a person the power to fly because humans cannot fly. However, a fast runner could be given the power of Lightning Speed, for example. A character skilled at fire-walking could be granted Resistance to Fire and Heat, while a skilled hypnotist might be given a Mind Control power.

**Material Strength:** Good (10).

**Tech Rank:** Monstrous (75).

**Availability:** Doctor Doom has one of these machines in a hidden laboratory within New York City.





**Level 1**

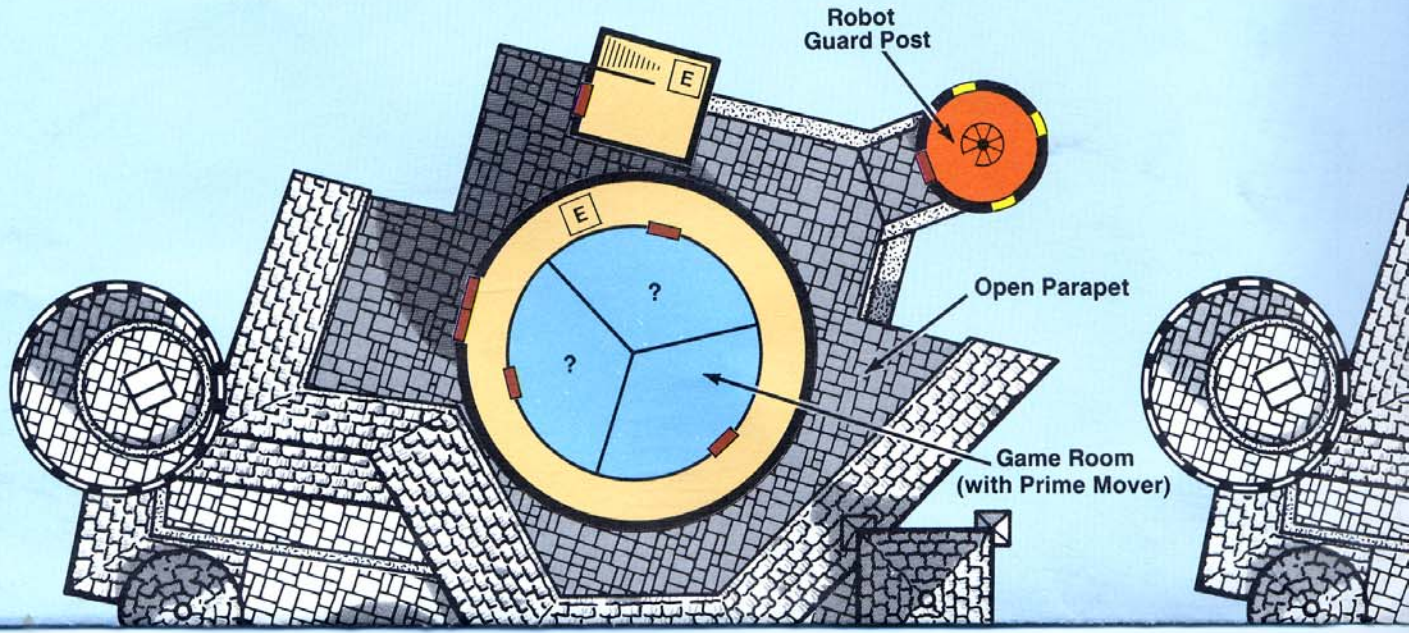



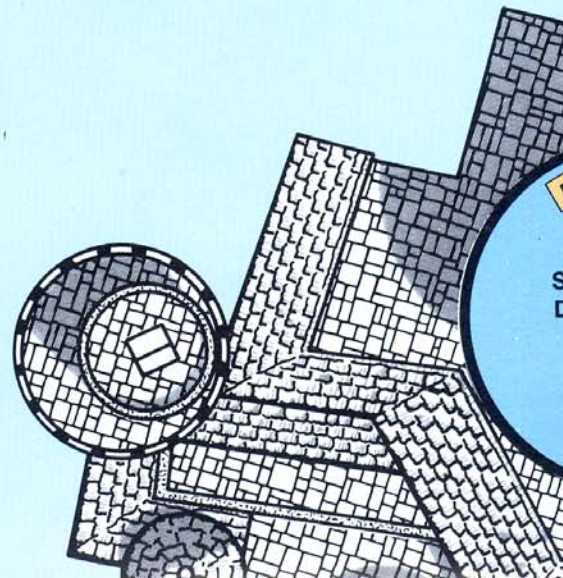
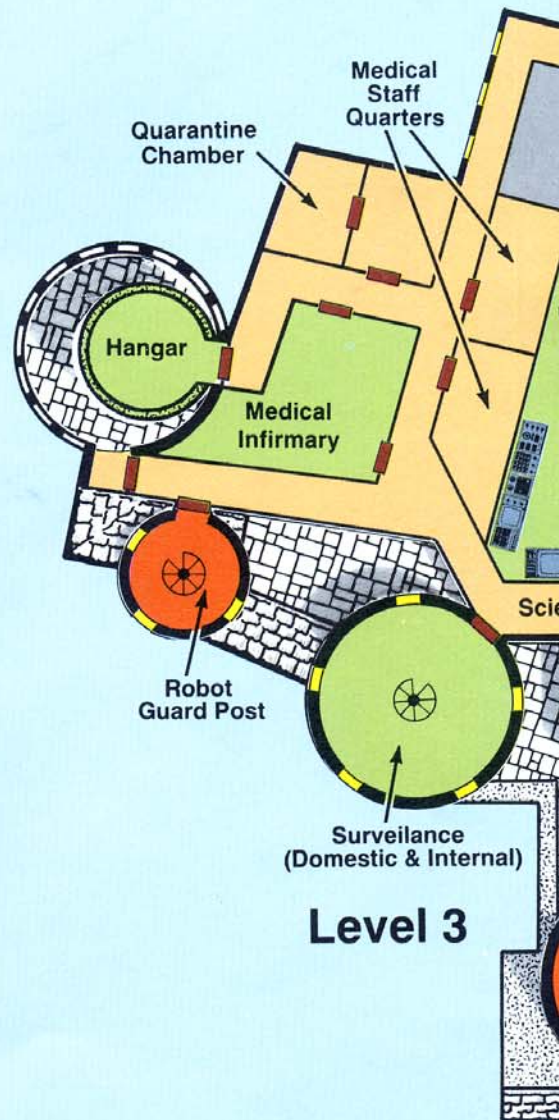



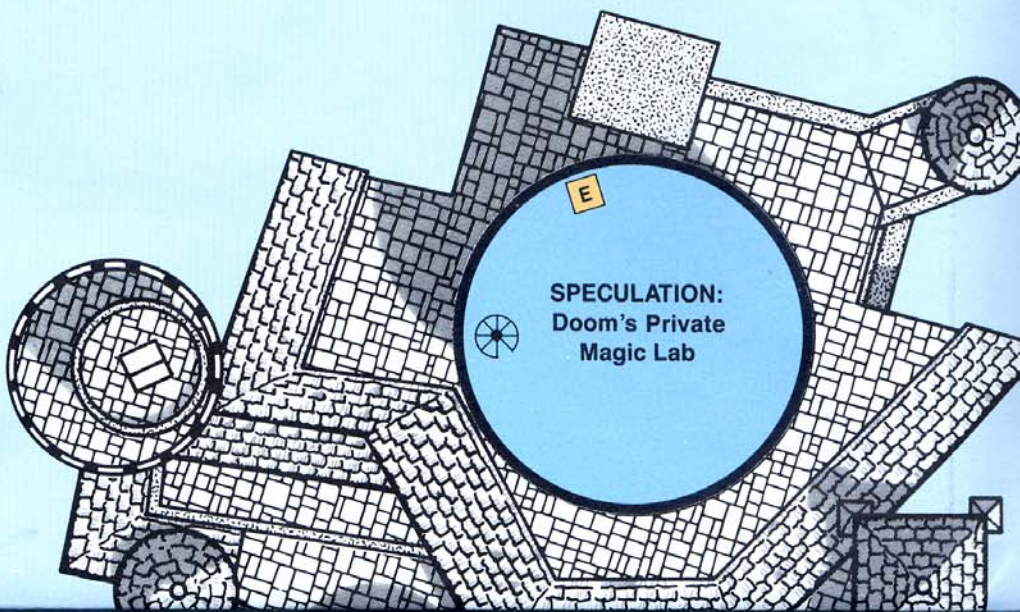
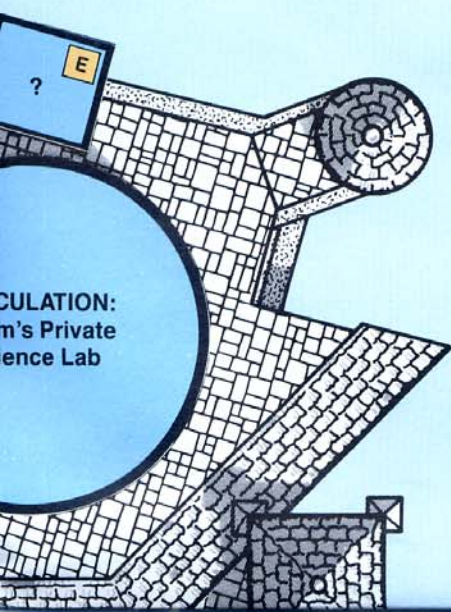
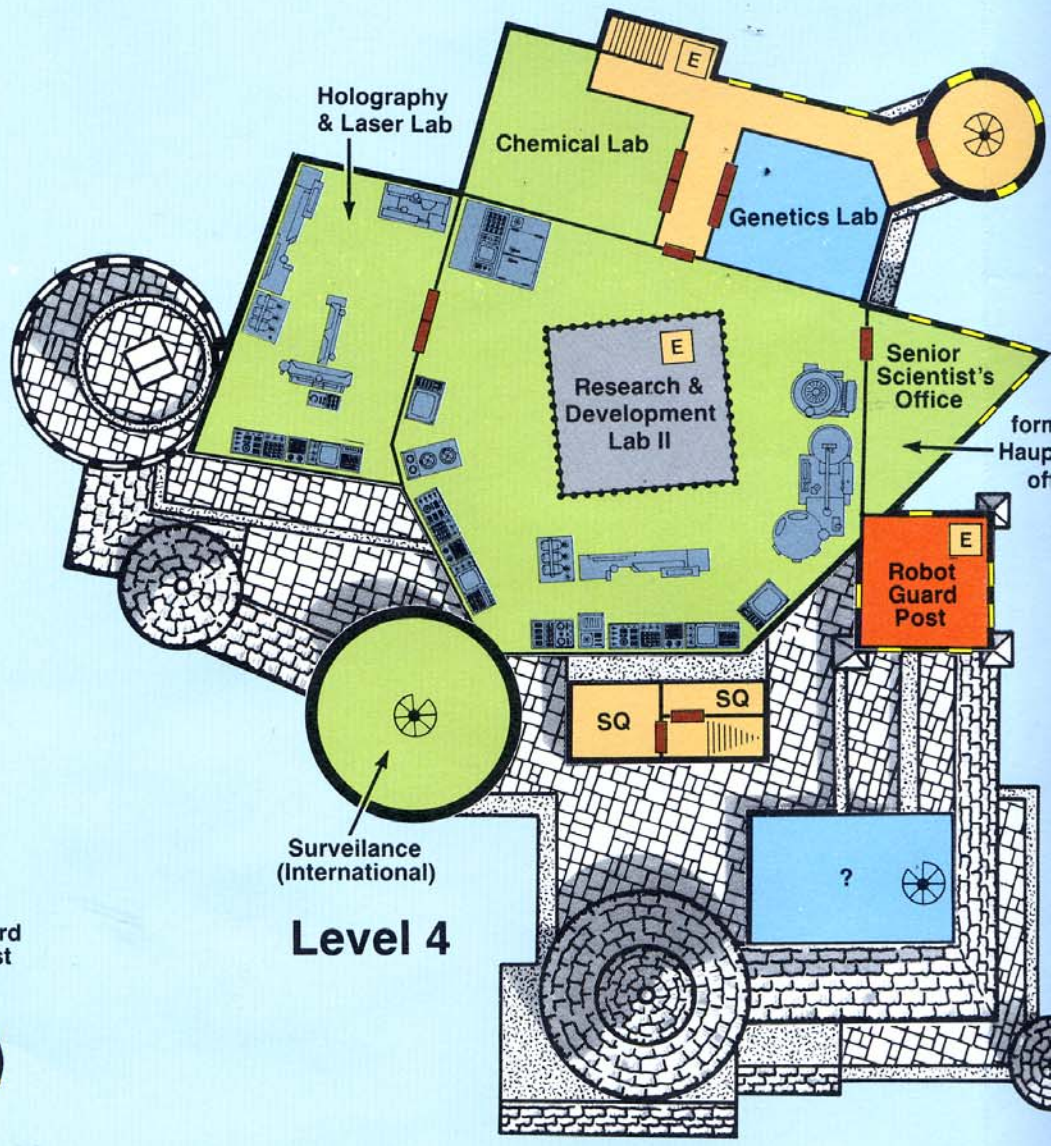



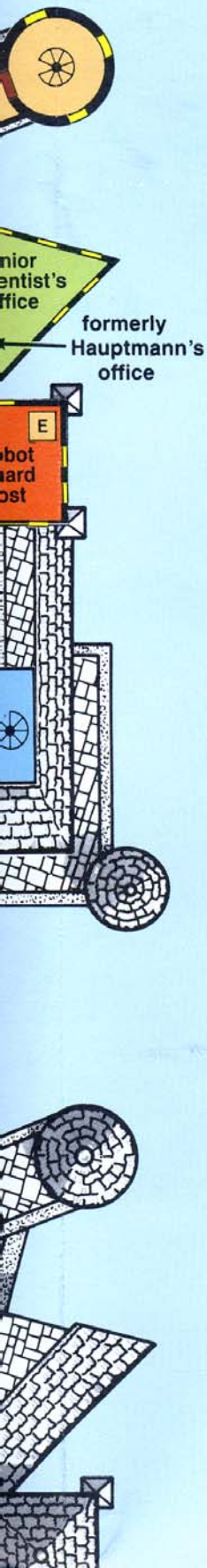

## CASTLE DOOM

*Full Analysis & Compilation of First Hand Details*

Recording: Benjamin Grimm, Reed Richards, Susan Storm Richards, Johnny Storm, Crystal Amaquelin, Sharon Ventura (FANTASTIC FOUR)

### Construction & Materials

Castle Doom Exterior: Amazing (50) material strength stone; tower roofs are generally of Excellent (20) material strength, though some reinforcement is to be expected in high-security areas.

Castle Doom Interior: Remarkable strength stone. Those walls surrounding Doom's above-ground laboratories and some of the other science areas within the castle are supplemented with energy screens that reflect the force of any impact toward its point of origin (Incredible Force/Energy Reflection). (See also 6906cdom1-cdom9)

### Defensive Strength

Guards posted along exterior walls at all times; standard shifts include eight Doom-Knights on the higher towers, six Warrior robots patrolling the lower parapets, four human Latverian Guardsmen watching the front gate and the main castle entrance, and a minimum of three Guardian robots patrolling the woods around the base of Castle Doom. Interior troops too erratic to predict.

Weaponry is to be expected if the castle has any warning of intruders above or below ground. Standard deterrents are Stunners (Remarkable force & range), Shock fields (1 area effect Incredible energy attack), Knock-out or Poison gas (Remarkable intensity for both; Endurance FEAT needed to avoid sleep or death), and, if an extreme show of force is needed, Doom will employ excessive measures such as the use of his Rainbow missiles or the Vortex Machine (see *Machines of Doom* for more details).

The weakest defensive point of Castle Doom is the submersible entrance through the Klyne River and into the catacombs of Castle Doom; entrance is staffed by two human guards (very lax in duties as this area is rarely used) with standard Latverian Guard weaponry and four or six Warrior robots. (See also 6906idef1, 6906idef2, 6906xdef1 - 6906xdef3)

### Incarceration

The majority of Doom's secure cells exist as parts of the original dungeons and catacombs of the castle (Levels B4 & B5). Secure, that is, for normal Latverians and nonpowered beings. Superhuman prisoners receive custom-built prisons of variable size and makeup; however, Doom does tend to restrict these prisoners to the second sub-basement (Level B3)—to leave this level is to risk the trap-laden level of B2 or become lost in the catacombs beneath the castle. Despite their isolation and relative lack of upkeep, Doom still has a heavy blanket of scanners and security sensors beneath it (Remarkable rank Detection). (See also 6906jails)

### Power systems

Deep within the bowels of Castle Doom is a complex nuclear reactor that is 70% more efficient in its energy output and radiation containment than any other fission reactors currently in use in America (Shift X energy output; Shift Z radiation damage if exposed to the unshielded reactor).

There are also backup hydroelectric generators that utilize the current of the Klyne river to power three subordinate generators. There is no single

### CASTLE DOOM: SUB-BASEMENTS

The sub-basements of Castle Doom range over a large amount of space and cumulatively encompass at least 30% more space than the castle itself. Mapping the sub-basements is next to impossible, since Doom favors the constant utilization of workspace and he changes the layout (shifting walls and tons of equipment) of sub-basements B2, B3, B5, and B6 to suit his needs at that time. Any of Doom's inventions would most likely be found in the major science labs on Level B4, including an isolated lab where I believe he creates and upgrades his suits of armor. On Levels B4 and below, the original stone gargoyles within the walls of the catacombs and tunnels have been supplemented with audiovisual sensors (Amazing rank Detection sensors; a two second sustained ultrasonic pulse can temporarily disable them for 21.2 seconds). Keep in mind that these are only secondary sensors on the lower levels; much of the security involves pressure plates on floors and walls, and intruders tend to be gassed more often than not as a deterrent—this also helps to keep down Doom's exterminator bills.

**Level B1:** *Cellars*—Wine storage and misc. housewares. Level B1 is accessible through the elevator in the kitchens and Doom's personal elevator. Level B1 is confined to the standard outline of the castle major; the public address tower and the robot construction building do not extend their foundations into the main cellars.

### Restricted Sub-basement Levels

**Level B2:** *Prisoner deterrence/Vehicle Storage & Maintenance*—This level is contorted with small winding passageways that lead only into various traps laid down by Doctor Doom. Separated from the main trap area is Doom's hangar, the access to the surface coming through the courtyard of the castle or via a ramp leading out behind the castle. All of Doom's known vehicles are stored here.

**Level B3:** *Superhuman Detaining Cells/Research & Development Labs*—Level B3 is comprised of former torture chambers that now contain all types of power inhibiting devices designed to detain and imprison superhuman foes. Separated by a variety of deadly cell blocks from these cells are Doom's main research and testing labs. The Memory Transference Machine used on Kristoff can be found here.

**Level B4:** *Catacombs/Major Project Labs*—Additional prison cells in a maze of corridors comprise 30% of the current Level B4. The space remaining involves Dr. Doom's major projects such as the Power Cosmic Energizer or the currently



**Level 5**

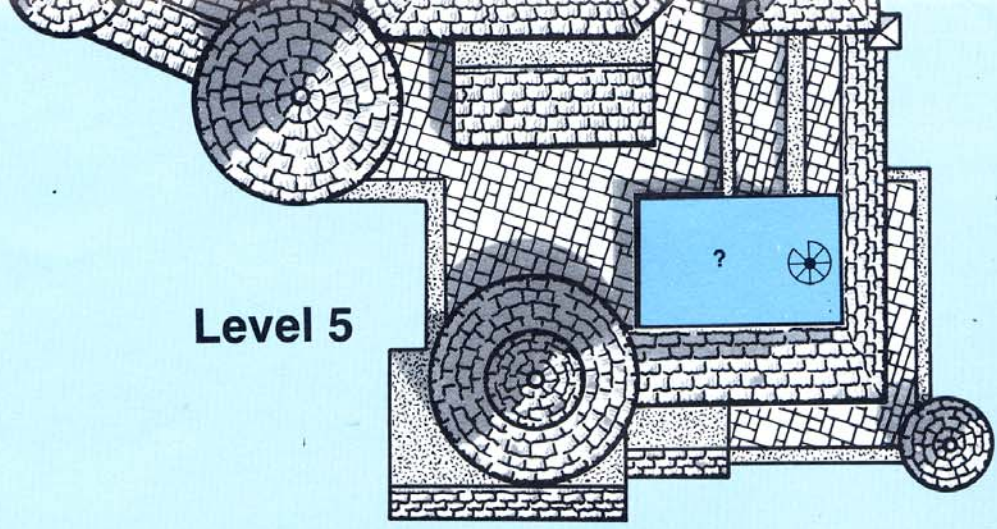

**Level 9**

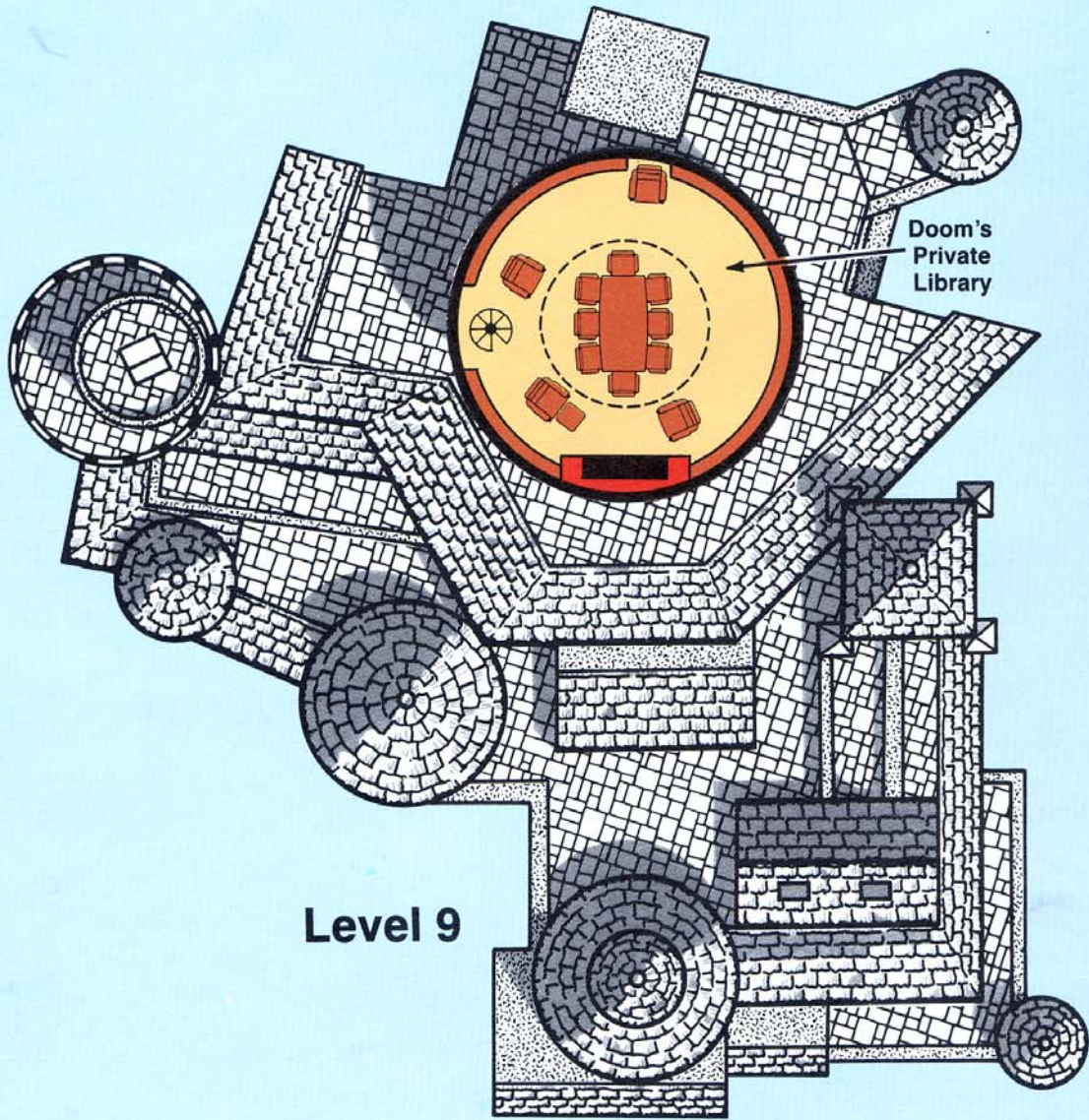



Level 6

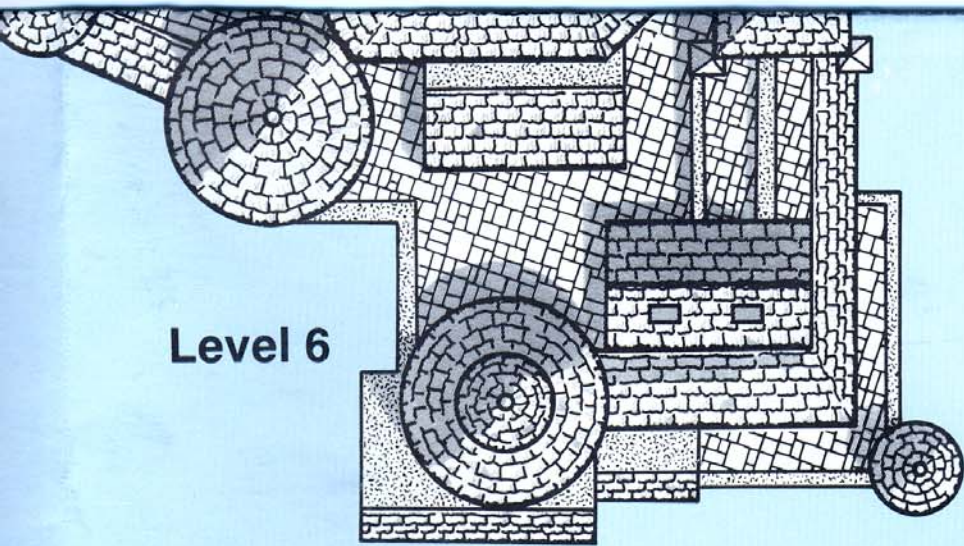

Level 7



Level 10

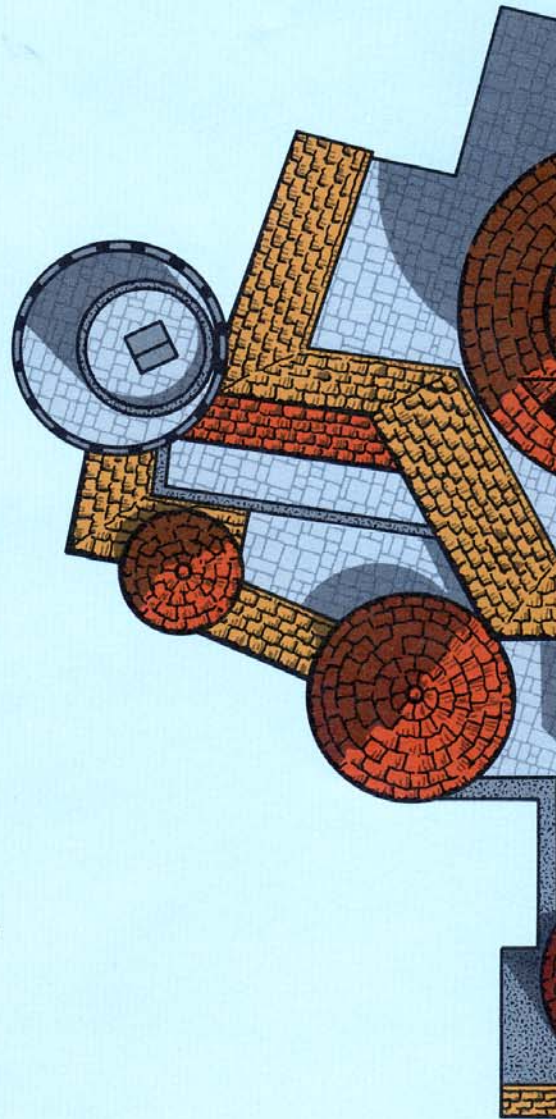
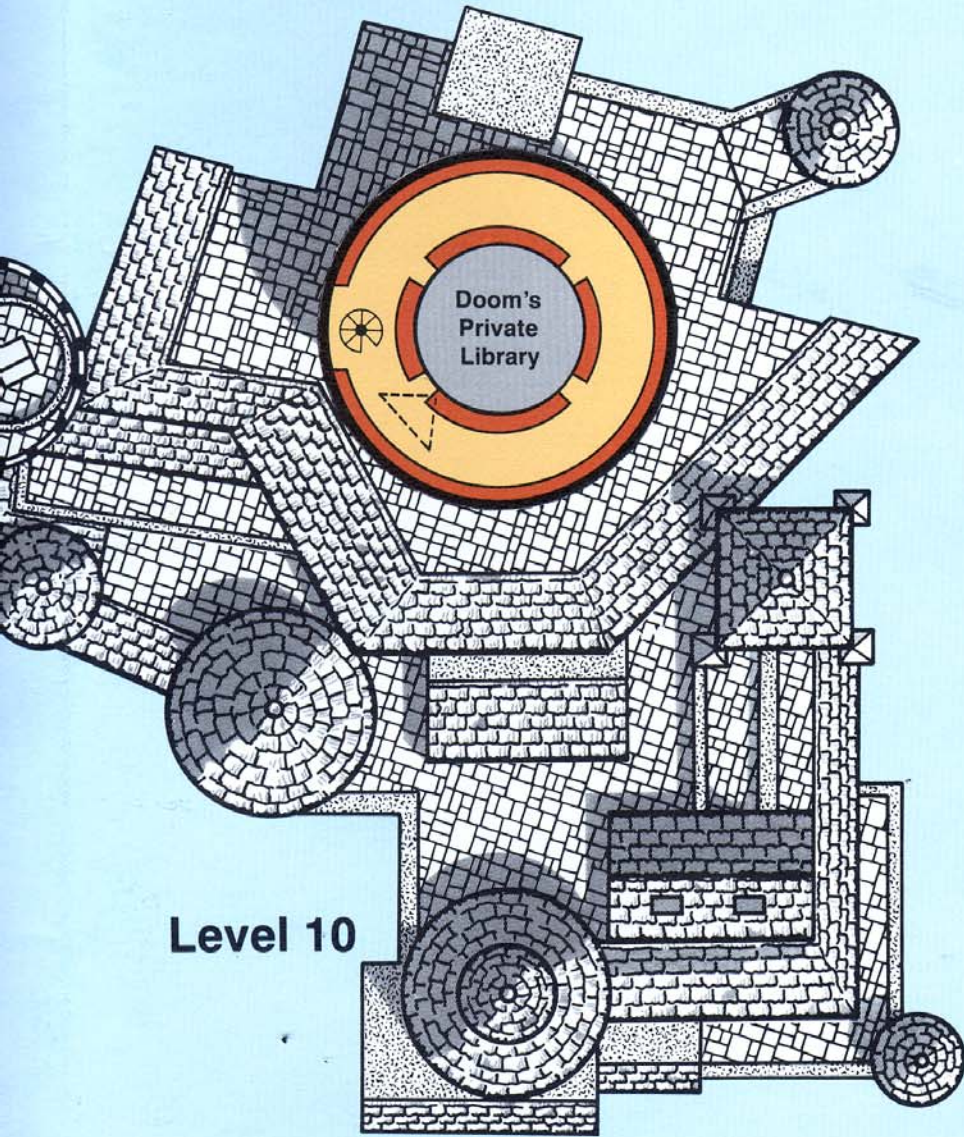



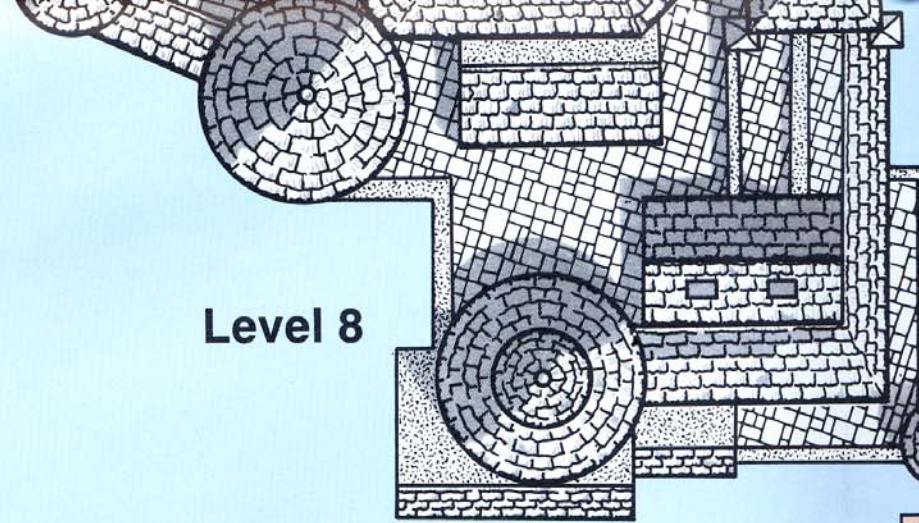
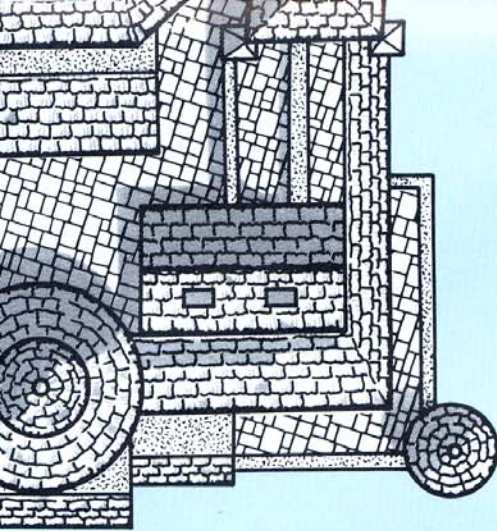



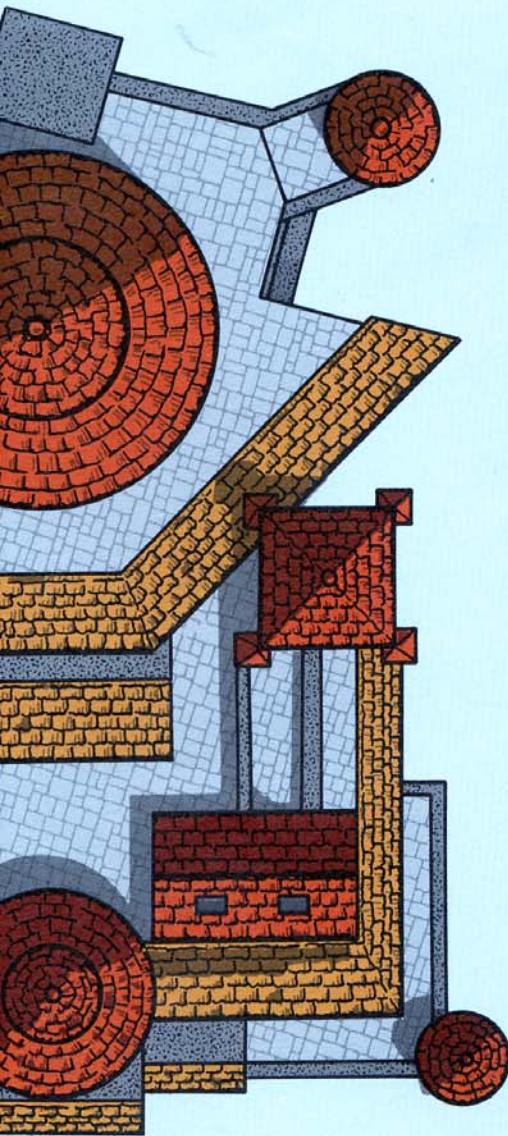

## Level 8



### Guide to Castle Doom

Color	Designation	Security
	: Domestic Area	Low
	: Scientific Area	Medium/High
	: Danger Area	High
	: Unknown Area	Unknown; anticipate High Security

### Intruder Alarm Responses

Security forces keep arriving until the threat or alarm is cancelled.

Low Security = Alarm brings 1-6 human guards (1d10-4) minimum

Medium Security = Alarm brings 1-6 Warrior robots (1d10-4) minimum

High Security = Alarm brings 1-10 Warrior robots + 1 Combat Doombot

### MEMORANDUM 12 JUNE TO: Colonel Fury, Director of SHIELD

Nicholas, as per your request for information on the layout and details of Victor Von Doom's files have been downloaded for your perusal. I regret that much of the information certain you can understand the minimal amounts of information Doom makes available generally visit as enemies and/or prisoners. I've broken down the information into basic files for easier focus; if you and your people are in need of assistance in any Victor, my team and I stand ready to assist.

Keep in mind that, though the castle's security can be breached, I am skeptical of escaping Doom's stronghold unscathed. There are simply too many factors surrounding behavior and actions for any agent with less experience than your own to comprehend. In my mind, I can improve your agents' chances in any endeavors with some new items that will augment many of your standard weapons and defensive systems to counteract some of the most common weaponry (at least that of his robots), and I believe I can provide your team with the know-how to activate Doom's self-destruct mechanisms placed in many of his defenses. Good luck, old friend.





#### Castle Doom Map Key

-  Door
-  Window
-  Pillar
-  Curtain/Banner
-  Fireplace
-  Spiral Stairs
-  Stairs Up
-  Stairs Down
-  Elevator
-  Throne
-  Statue
-  Suit of Armor  
(disguised robot of RM Strength)

main power feed into the castle; power is fed through a virtual spider-web of cables and energy ducts spread throughout the entire castle. (See also 6906energy)

#### Security systems

Exterior walls can be reinforced with force screens (with ten round warning of attack), raising their material strength to Monstrous (75). All internal doors tend to be reinforced wood and metal, all with a minimum of Excellent material strength. Stay alert for telltale odors of ozone—many doors and windows are electrified to the point of being able to disintegrate Good strength materials. (See also 6906sec1-sec6)

#### Surveillance systems

Amazing rank visual, audible, and motion sensors honeycomb the castle complex (and the country); only the fear in Doom's underlings slows his knowing all of what goes on in his domain, as they are understandably reluctant to bear bad news. Doom has built triple-redundancy protective devices around his surveillance and security systems (Amazing intensity Reason FEAT to disable one system for 3d10 rounds without main controls) and it is not possible to disable all the surveillance devices in one fell swoop. The best bet is to cloud the sensors with too much input and overload the operators by giving them too much to look at or listen to; Doom's fondness for robots does not extend to this area, even though robots cannot be as easily distracted from their tasks. (See also 6906spy1-spy3)

inert Doomsman series of androids.

**Level B5:** *Dungeons/Nuclear Reactor*—Doom's final dungeons comprise 12 cells, all of which have been empty since he regained his throne from Zorba. This level may contain more secret labs, but the only solid fact known is that this heavily shielded level also contains the nuclear reactor that powers Castle Doom.

**Level B6:** *Miscellaneous Secret Rooms/Tunnels*—An underground offshoot of the Klyne river runs through a number of large caverns on this level. This has already been mentioned as one of the least hazardous entrances to the castle. Also on this sprawling level of worked stone and honeycombed caves are tunnels leading to safe houses throughout Latveria, Doom's magical summoning room (no longer in use with the recent salvation of his mother), and a supplemental robot construction facility.

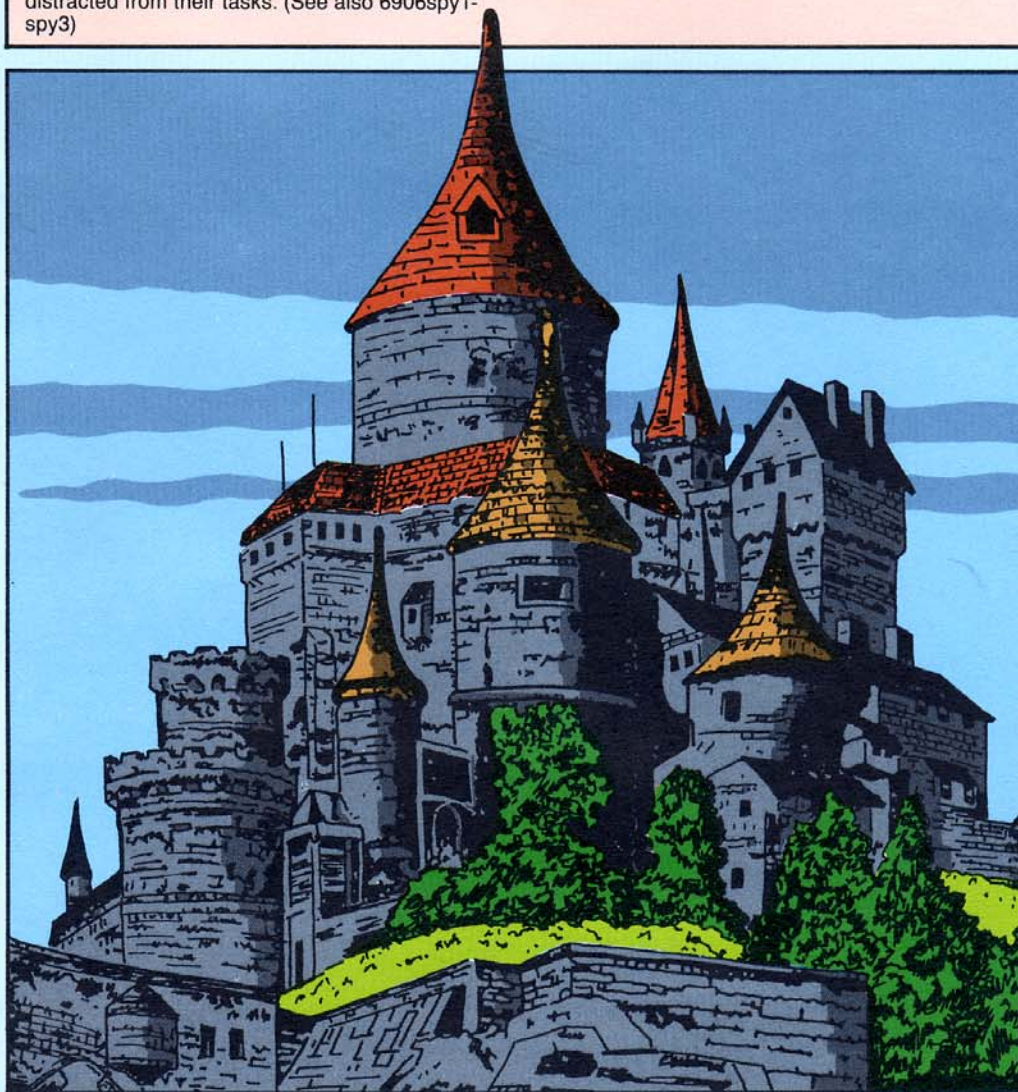

etails of Victor Von Doom's castle, my the information is incomplete; I am om makes available to those who nformation into a quick outline and ssistance in any operations involving

I am skeptical of an agent's chances any factors surrounding Doom's own to compensate for. With that in some new items. I should be able to o counteract some of Doom's more provide your technological staff with in many of his lesser robots. Again,

Respectfully,  
Dr. Reed Richards  
Fantastic Four, Inc.



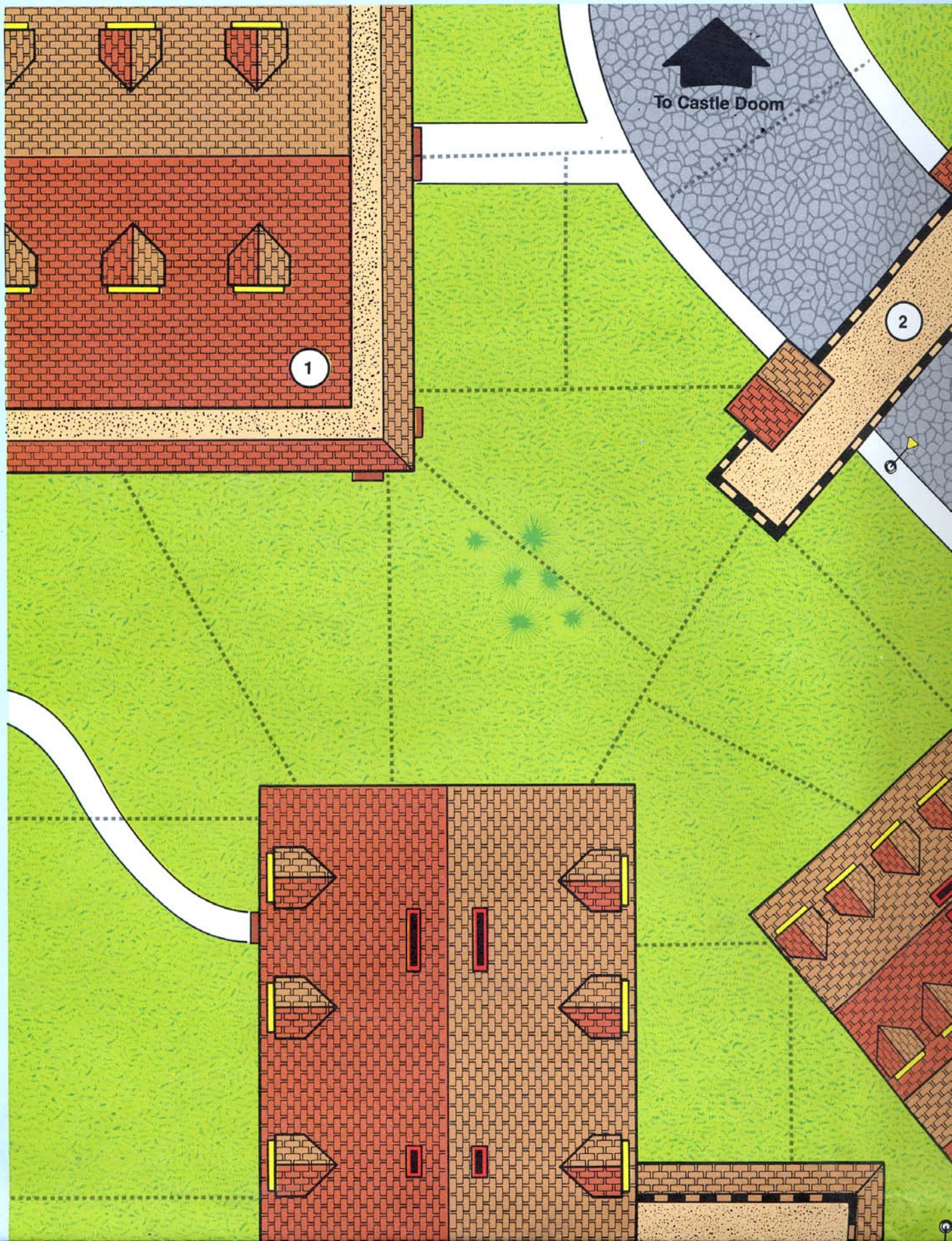









14

15

3

16

Lake Victor



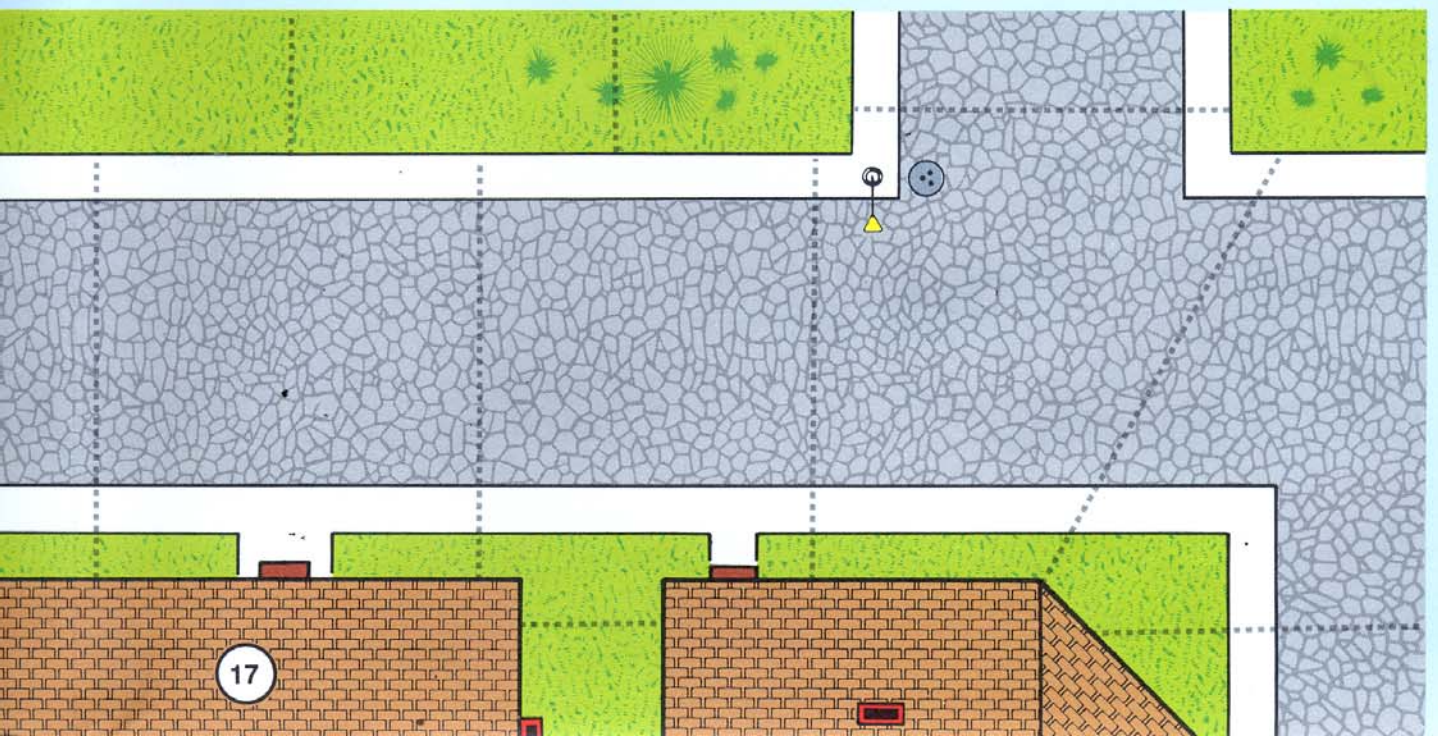
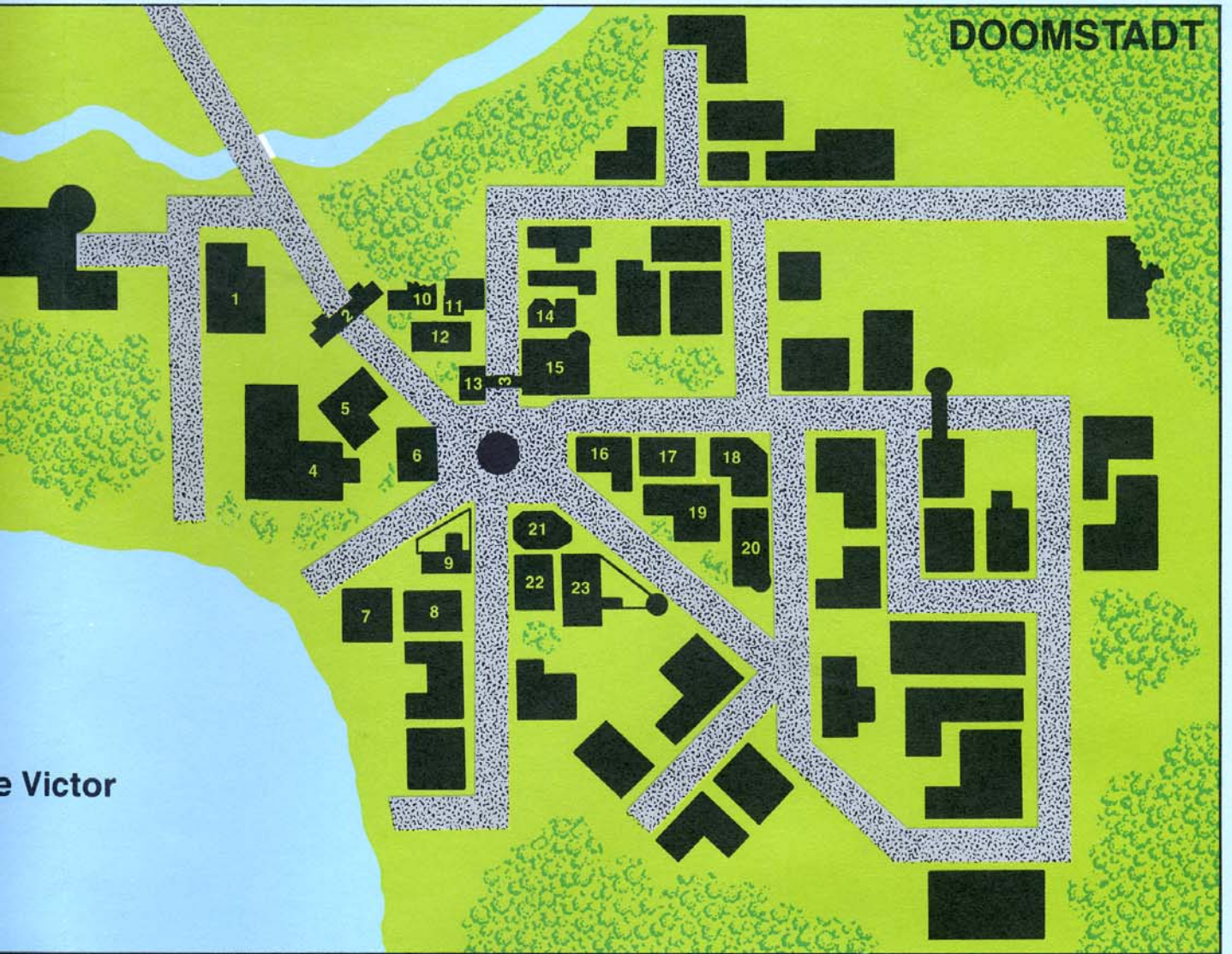



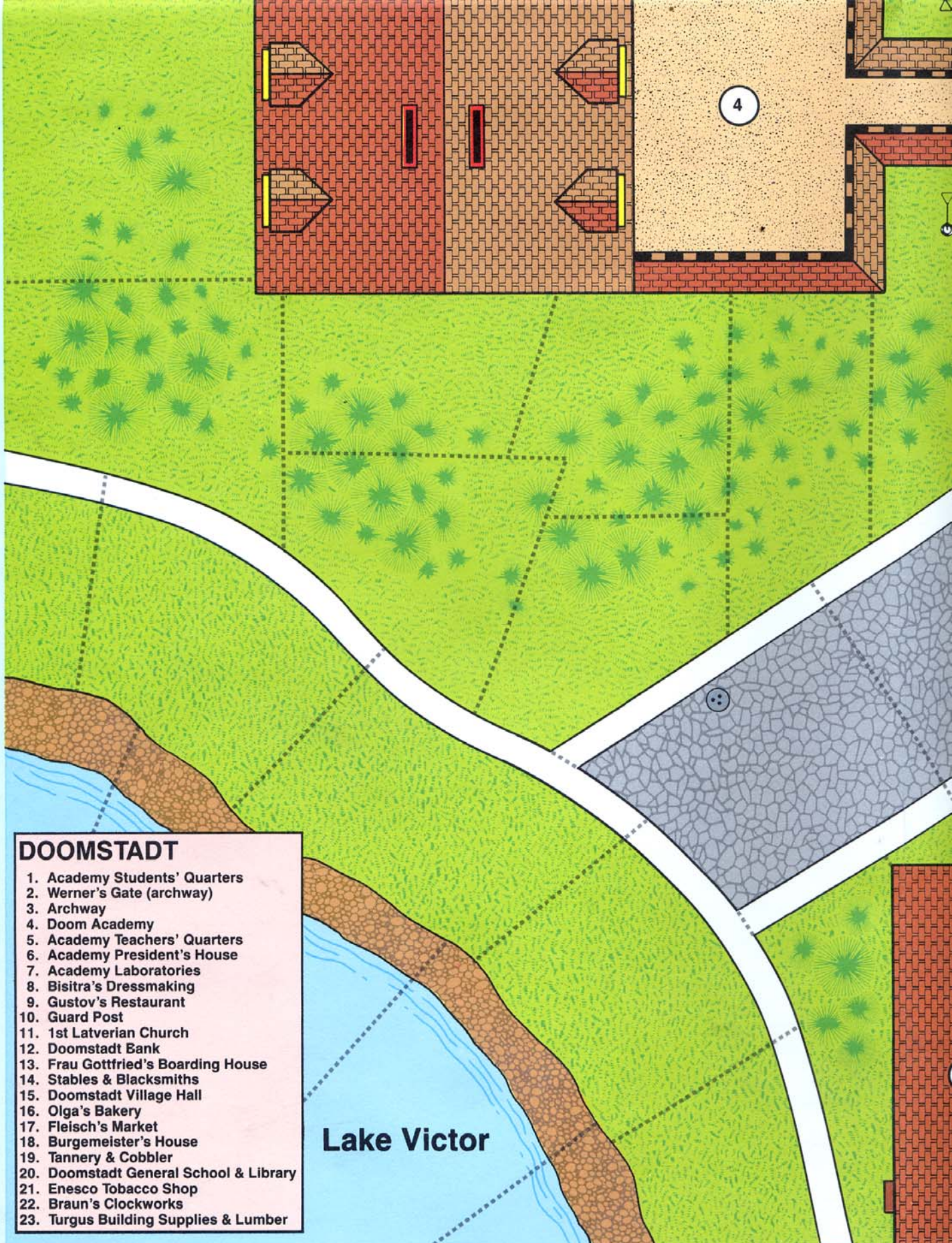

## DOOMSTADT

1. Academy Students' Quarters
2. Werner's Gate (archway)
3. Archway
4. Doom Academy
5. Academy Teachers' Quarters
6. Academy President's House
7. Academy Laboratories
8. Bisitra's Dressmaking
9. Gustov's Restaurant
10. Guard Post
11. 1st Latverian Church
12. Doomstadt Bank
13. Frau Gottfried's Boarding House
14. Stables & Blacksmiths
15. Doomstadt Village Hall
16. Olga's Bakery
17. Fleisch's Market
18. Burgemeister's House
19. Tannery & Cobbler
20. Doomstadt General School & Library
21. Enesco Tobacco Shop
22. Braun's Clockworks
23. Turgus Building Supplies & Lumber

Lake Victor







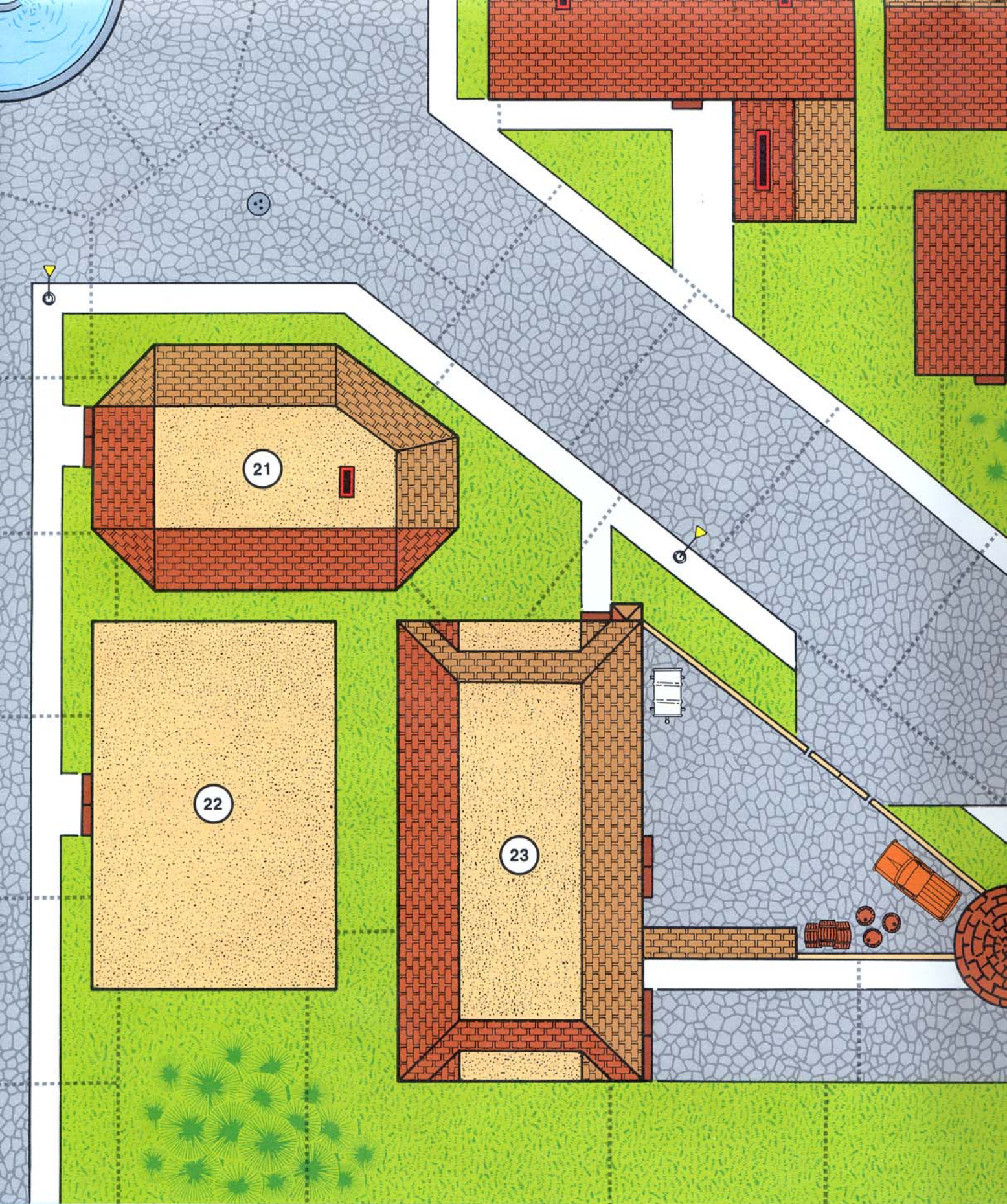

21

22

23



