

# MARVEL SUPER HEROES

Advanced Game Official Accessory

## The FANTASTIC FOUR™ Compendium

by David E. Martin



All Marvel characters and the distinctive likenesses thereof are trademarks of the Marvel Entertainment Group, Inc. MARVEL SUPER HEROES and MARVEL SUPER VILLAINS are trademarks of the Marvel Entertainment Group, Inc. ©Copyright 1987 Marvel Entertainment Group, Inc. All Rights Reserved. Printed in USA. PDF version 1.0, 2000.

The names of characters used herein are fictitious and do not refer to any person living or dead. Any descriptions including similarities to persons living or dead are merely coincidental. PRODUCTS OF YOUR IMAGINATION and the TSR logo are trademarks owned by TSR, Inc. Game Design ©1987 TSR, Inc. All Rights Reserved.





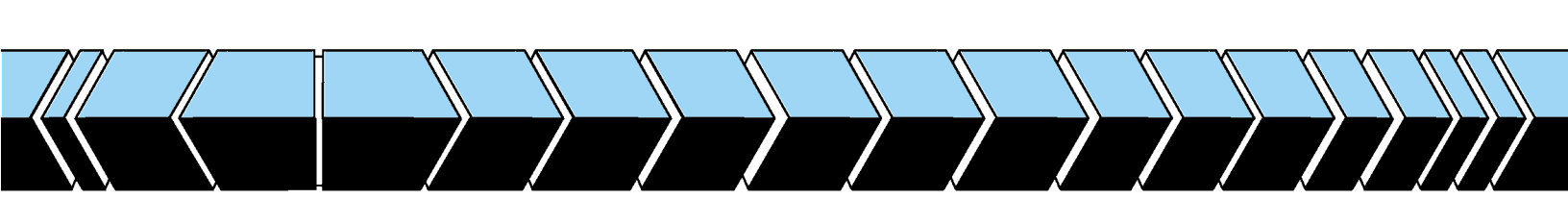

*This book is dedicated to Jack Kirby in appreciation of his unique contribution to the field of comic books.*

## INTRODUCTION

Welcome to the world of the Fantastic Four. The FF are a unique group unlike any other in the modern Marvel Universe. They were the first members of the class of modern superhumans. They were the first superheroic team to form since the disappearance of such groups in the early 1950s. The FF were the first superheroic team to be financially self-supporting. Most importantly, two and a half decades of printed adventures make the FF the stablest team in the history of the Marvel Universe.

The FF represent a curious blend of traditional superheroes and scientific adventurers. The FF have never been primarily a crime-fighting organization. Their primary efforts have instead involved discovery, investigation, and exploration of unknown or abnormal scientific phenomena. Through Reed Richards' leadership, the FF have introduced such things as Earth's first starship, the Negative Zone, the Microverse, alien races, new worlds, and a nearly infinite array of inventions including the superheroes' tailor's friend, Unstable Molecules.

Like any benevolent superheroic team, the FF possess a Rogues' Gallery of adversaries. The FF's annals have brought us such memorable villains as Dr. Doom, Galactus, the Skrulls, and the ne'er-do-wells of the Frightful Four.

This book is designed to serve as a guide to the world of the FF. It may be read as a comics reference book or as a sourcebook for gamers seeking to play out the FF's history. The first chapter covers the team itself in all its various incarnations. The second chapter deals with family and friends of the FF. The third section is an overview of various races and organizations closely tied to the FF, whether as allies or adversaries. Important individuals in each group are detailed as well their homelands and equipment. Fourth comes the Fiends and Foes, the listing of various of the FF's adversaries. In fifth place is the Travel Guide, a guide to places and buildings featured in the FF's history, including the Baxter Building and Four Freedoms Plaza. The book concludes with a section detailing the vehicles that have served the FF through its long history.

## A BRIEF HISTORY OF THE FANTASTIC FOUR

The Fantastic Four has its origins at Empire State University in New York state. There, two young geniuses and a rough-hewn athlete came together. Reed Richards, son of the billionaire inventor Nathaniel Richards, was roommates with football player Ben Grimm. Although they came from opposite backgrounds, Reed and Ben became close friends. They confessed their dreams to each other. Reed wanted to build a starship. Jokingly, Ben agreed to pilot the ship when it was built.

Reed also met the strange genius, Victor von Doom, from the eastern European country of Latveria. Reed recognized a genius equal to his own. He did not realize that Von Doom's ego far surpassed his intellect. Reed discovered von Doom was carrying on dangerous experiments and using flawed calculations to guide his efforts. When Reed attempted to correct von Doom's calculations, the latter saw it as interference and sabotage. Von Doom's experiments literally blew up in his face. He left the U.S. to pursue other studies that would eventually transform him into the dreaded Dr. Doom.

As Reed progressed in college, he met a young girl, Sue Storm, who would someday become his wife, and her precocious brother, Johnny.

Eventually Reed began to apply his skills to increase mankind's knowledge. His father had disappeared and left him two billion dollars. Reed decided to use the money to build his starship. He gathered additional funding from the U.S. government, which supplied him with a base of operations near Central City, California. Sue joined Reed there. While Reed's ship was still in the planning stage, the four met and defeated their first alien invader, Gormuu. This spurred Reed to double his efforts because he saw his inventions as a way of defending humanity from alien threats. Reed was soon to know how correct he was.

The government began to have second thoughts about their financial role in Reed's project. Reed feared they would soon withdraw their support. Since Reed had exhausted much of his own fortune, the project would come to a halt unless he took a drastic step. He reminded his old friend Ben, now an Air Force test pilot, of an old promise. Ben was to fly

the starship on a secret, unauthorized test flight. Reed would ride as co-pilot. Sue and Johnny Storm forced Reed to let them come along as observers.

The flight began smoothly; the four snuck into the launch site and blasted off before anyone noticed. The trouble came when the ship was in orbit. Reed had been forced to cut back on the radiation shielding of his prototype. It was safe enough for the normal hazards of space, but it was unprepared for the freak combination of sunspot activity and cosmic radiation that affected the ship and the foursome. The ship dove back to Earth.

The ship crashed near Ithaca, New York. Miraculously, the four had survived, but they had been changed. The weird energy had mutated their genes and given them super powers. In the middle of the crash site, they realized they now had a responsibility to use their powers to help humanity. Henceforth they would be known as the Fantastic Four.

Fortunately, Reed still had enough of his fortune left to bankroll what was to be the first new super-hero team since World War II. They left California to set up operations in New York City. In the years that followed, the Fantastic Four fulfilled Reed's dream of benefitting and protecting humanity. Reed's inventions made giant strides in technology. More importantly, the group fought the emerging string of self-proclaimed supervillains and the early wave of alien invasions. The FF's greatest feat was defending the Earth against Galactus, Devourer of Worlds, not once but three times.

Time changed the team. Reed and Sue married and had a son. Ben fell in love with Alicia Masters, a famous sculptor, then lost her to Johnny. Reed and Sue separated over Reed's drastic method of dampening their son's powers. Other members came and went. Their headquarters, the Baxter Building, was wrecked several times, then sliced from its foundation, and finally destroyed. Now they have a new headquarters and a new team roster. Reed, Sue, and Franklin have left the team for a life in the suburbs. Ben now leads the team. Life goes on, things change, and so it goes with the Fantastic Four.

# THE FANTASTIC FOUR

The Fantastic Four Inc. is one of the best known super-heroic organizations in the world. It makes its services available without charge anyplace in the world there is a threat beyond the capabilities of conventional forces. The group also does applied scientific research; revenues from patent leases makes the FF one of the most profitable groups around. Like most superheroic teams, the FF remain an independent organization free of government control. However, the FF do have a close working relationship with many national governments and organizations.

## TEAM ROSTERS

The term "Fantastic Four" has been used to refer to a variety of teams operating under the aegis of Fantastic Four, Inc. While the public perception of the team is of its founding members, the active membership has varied through the years, as new members are brought in to temporarily replace founding members. Unlike such teams as the Avengers and the X-Men, however, at least two of the founders have been members in each team calling itself the Fantastic Four. In order, the past teams rosters have been:

1. Mr. Fantastic, Thing, Human Torch, Invisible Girl (founders)
2. Mr. Fantastic, Thing, Human Torch, Crystal
3. Founders
4. Mr. Fantastic, Thing, Human Torch, Medusa
5. Founders
6. Mr. Fantastic, Human Torch, Invisible Girl, Power Man
7. Founders
8. Thing, Human Torch, Invisible Girl, Reed Richards of Earth-A (in disguise)
9. Founders
10. Founders and Frankie Raye
11. Founders
12. Mr. Fantastic, Human Torch, Invisible Woman, She-Hulk
13. Founders
14. Thing, Human Torch, Crystal, Ms. Marvel II



## MISTER FANTASTIC

Reed Richards

F	GD	(10)	Health: 42
A	TY	(6)	
S	TY	(6)	Karma: 100
E	EX	(20)	
R	AM	(50)	Resources: RM(30)
1	EX	(20)	
P	RM	(30)	Popularity: 50

### KNOWN POWERS:

*Elongation:* Reed can stretch or deform any part of his body with Monstrous rank. This enables him to elongate any part of his body any distance up to 1500 feet. He most often uses this to increase his reach and travel speed.

*Plasticity:* Reed can consciously distort any part of his body with Amazing rank. This enables him to perform a variety of Stunts that simulate other powers.

- Bouncing Ball—Reed can travel at Amazing speed by transforming himself into any of a number of resilient shapes, such as balls or springs.
- Gliding—Reed can transform himself into aerodynamic shapes such as parachutes or hang-gliders. In normal air, he only drops 15 ft for each turn he stays aloft. In this form he can support an additional 1000 pounds (enough to

hold the rest of Fantastic Four).

- Imitation—Reed can alter his basic features to resemble any other man with his hair and skin tone.
- Phasing—Reed can lower his body's cohesion to such an extent he can actually flow through minute openings.
- Shapeshifting—Reed can transform himself into any solid mass he can imagine. Normally he takes such forms as spheres, rectangular solids, pyramids, and so on, rather than complex shapes such as those of other life-forms.
- Two-Dimensionality—Reed can flatten himself to the thickness of a sheet of paper or narrow his body's width to pass through the eye of a needle.

*Body Armor:* Reed's malleable form gives him Remarkable protection against physical attacks and Good protection against energy attacks. By enveloping a bomb and then expanding along with the explosion, Reed can reduce the force of the blast by his Power rank number. Feats such as this physically exhaust Reed, though. He cannot do it often. In game terms, Reed must make a FEAT roll at his Power rank against the intensity of the explosion every time he tries to envelop explosions once he has absorbed 20 points of damage.

*Hyper-Intelligence:* Reed's Amazing Reason is one of the highest in the galaxy, insofar as engineering and laboratory work are concerned.

*Hyper-Invention:* Reed's Amazing rank makes him one of the leading inventors in the world today. He is not only able to formulate his theories but actually create practical devices utilizing them, often while the rest of the Fantastic Four stand around watching. He can operate or alter previously unknown alien devices within minutes of first encountering them.

**TALENTS:** Reed is one of the world's leading experts in Electronics, Physics, and Engineering. He is also one of the few people on Earth to be expert on other dimensions and the ways to travel to and through them. Reed's patents are so valuable that he is able to bankroll the Fantastic Four, Inc., without any undue financial stress.

**CONTACTS:** Reed is a founding member of the Fantastic Four and has all the group's affiliations. Due to his reputation and accomplishments in the scientific field, he can call upon the Physics or



Engineering departments of any university in the country.

**BACKGROUND:** Reed was born to Nathaniel and Evelyn Richards. His mother died when he was 7. Nathaniel was a brilliant scientist who fueled the young Reed's interest to uncover new knowledge. The two men's drives took them in different directions and Reed rarely saw his father in the decade before Nathaniel left Earth for a new dimension.

Reed was a brilliant scholar who attended several universities. While at Empire State University he met many of the people who would later affect his life— especially Ben Grimm and Victor von Doom. Later he attended The California Institute of Technology, Harvard, and Columbia University. While at Columbia he became friends with his landlady's niece, the 12-year-old Sue Storm. After graduation, Reed came into a two billion dollar inheritance from his now vanished father. He invested most of the money in the building of the ship that led to the creation of the Fantastic Four. Although his decision has frequently brought Reed near bankruptcy, he is the holder of so many profitable patents that he has always been able to regain his fortune. His financial wealth is so great that he was able to buy the Baxter Building outright, cover the losses of its tenants when, the building was later destroyed, and build the new Four Freedoms Plaza, the team's new headquarters.

Reed and Sue were married a few years after the FF's formation. The marriage has its rocky spots—Sue even left him Once—but is now stable. They have one child, Franklin; a second child was stillborn. Although Reed is a devoted father, he occasionally lapses into nearly neglecting Sue and Franklin's existence. The almost perpetual crises that involve the FF have had a detrimental effect on the Richards family. To counter this, Reed and Sue have moved away from the FF to gain a semblance of normalcy. At this time, they are retired and are concentrating on rearing Franklin.

The cosmic radiation increased Reed's already formidable intellect. This has enabled Reed to create leading edge developments that surpass most terrestrial and some alien technologies. The fruits of Reed's unceasing genius permeate Earth's culture: the results vary from pure theory to the most basic superhero

accessory, the unstable molecules. Only Tony Stark and Forge have had an equal impact on society in this regard. With a successful Reason FEAT, Reed is able to use any alien technology he encounters, often incorporating the new discoveries into his own work.

**RUNNING MR. FANTASTIC:**

Reed is an intellectual who prefers to examine foes and if possible negotiate with them before actually fighting them. He is often intrigued by the scientific implications of a problem, so much so that he almost forgets there is a problem in the first place. As Ben once put it, if an alien stubbed his toe, Reed would want to spend ten years studying it. Reed is an extremely likeable fellow who keeps a pleasant smile on his face. However, he does occasionally lapse into depression over long-standing unsolved problems, most notably Ben's inability to return to human form and Franklin's mysterious potential. Reed is a humanitarian who will try to prevent any intelligent being from suffering. This can lead him to do controversial things that fly in the face of all apparent logic, such as when he once revived Galactus.

**INVISIBLE WOMAN**

**Susan Storm Richards a.k.a. "Invisible Girl"**

F	GD	(10)	Health: 46
A	GD	(10)	
S	TY	(6)	Karma: 40
E	EX	(20)	
R	GD	(10)	Resources: RM(30)
I	EX	(20)	
P	GD	(10)	Popularity: 50

**KNOWN POWERS:**

*Invisibility (Physics type):* Sue possesses Excellent rank Invisibility. She can make herself transparent to visible light, but not infrared, ultra-violet, radiowaves, nor hard radiation. She can be harmed by attacks and detected by senses that use these forms of energy. She can project this power into an invisibility field that covers a single target site of up to 40,000 cubic feet in volume at a maximum range of six areas. She can use her power to make a target invisible while remaining visible herself. She has perfected this Stunt in ways such as "peeling away" visual barriers to reveal their hidden contents or the

everyday act of wearing her invisible costume under her street clothes. Sue has also developed the ability to use her power to negate another's use of physics-type Invisibility; this interference renders the target visible.

*Force Field:* Sue can generate a psionic energy field of Monstrous rank. This gives her rank protection against physical and energy attacks and extremes in her environment. The Force Field can be modified instantaneously to allow or block the passage of air. The Force Field can protect a single area at full strength. For each doubling of the area Sue protects with her field, the rank drops by -1CS. Thus Sue can cover up to 256 areas with only Feeble protection. The power is a function of Sue's conscious mind; as such, it cannot function if Sue is unconscious or if her higher reasoning is somehow controlled by another.

Sue has developed her power into a variety of stunts, any of which can be used without cost.

- Kinetic Bolt—Sue can channel her power into a surge that does Power rank damage. She can alter the k-bolt's shape at will to create wide, blunt cylinders, sharp needles, or a flurry of invisible spheres.
- Landing cushion—Sue can project her power to form a cushion that can absorb the inertia of falling targets and absorb up to Monstrous damage.
- Flight—Sue can lift herself up six stories onto her force field, then rapidly change its shape to carry her swiftly through the air. She can travel at 2 areas per round for a maximum of four hours before she needs rest. (To an onlooker, it appears that Sue has a low altitude form of True Flight.)
- Power Negation—By forming her field around a super-powered target, Sue can block the release of that target's powers. This in turn frees her victim's own targets from any continuing attacks they were suffering. This Stunt only works against physical, or energy powers whose ranks are less than Sue's Monstrous rank.
- Suffocation—The Invisible Woman can attempt an Amazing rank FEAT roll against a target's Agility to project her force field around his head (or whatever bodily part an alien might use to breathe), isolating the target from breathable air. Treat such victims as suffering the effects of suffocation.

**TALENTS:** Sue has Performer abilities, a reflection of her early career choice to be an actress. Although her fledgling acting career was derailed by her transformation into the Invisible Girl, Sue retains her thespian skills. She mostly uses them in the adoption of secret identities or When doing public relations work for the Fantastic Four. Sue also possesses Martial Arts E when using her powers.

**CONTACTS:** Sue is a founding member of the Fantastic Four and has all the group's contacts, such as the Avengers, the Inhumans, and the various mutant teams under Professor Xavier's guidance. In addition, she has much closer ties to Namor than any of the rest of the group.

**BACKGROUND:** Sue Storm was born in Glenville, New York to Dr. Franklin and Mary Storm where she lived a normal suburban childhood. The only dark spot was when her father was imprisoned for performing undisclosed, illegal medical procedures. At age 12 she met and befriended the 23-year-old Reed Richards when he lived in her aunt's NYC boarding house. As an adult, she became an actress and had a few small parts on television. Upon learning that Reed had moved to California, Sue followed, perhaps with the idea of conquering Hollywood. Instead she conquered Reed's heart. The two quickly became engaged. Sue was so devoted to Reed that when she learned of his and Ben's plan to take off in a prototype starship Reed had built, Sue offered herself and her brother as passengers to show her faith in his plans.

As both a striking woman and the first heroine in decades, Sue received a great deal of attention from would-be suitors. The most notable was the Sub-Mariner, Namor of Atlantis, who saw Sue as his ideal mate until persuaded otherwise. Sue and Namor later became steadfast friends, so much so that Namor was behind the plot to re-unite the separated Sue and Reed.

When Sue was transformed into the Invisible Girl, her reproductive system was altered as well. Her first child, Franklin, was born possessing as-yet-undefined powers of great strength. Her second child was stillborn. It is unknown whether Sue can bear other children, although her doctor has recommended against it. Sue wants Franklin to experi-

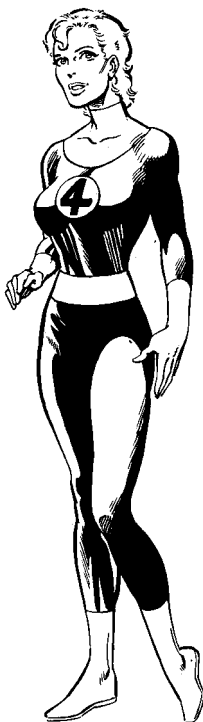

ence the same normal childhood she had. She has twice tried to create a suburban existence for her family, complete with secret identities. Unfortunately neither attempt was successful. Still game to try, Sue has once more set about to raise Franklin like a normal child.

**RUNNING THE INVISIBLE WOMAN:** In her early adventures, Sue was in love with Reed but could be confused by attractions to other powerful men such as Namor. Now she is a devoted wife and mother who can switch from being a kind, compassionate woman to a she-tiger if her husband, son, or extended family are threatened. However, as a mother, she can also identify similar behavior in others; she has stopped fights when she realized the FF's opponents were in fact driven by the same familial drives as she was. She is the soul of the Fantastic Four and its extended family. As such, if something were to separate her from the team for an extended time, the FF would lose its drive and stability.

**A NOTE ON THE SECOND CHILD:** Because Sue's second child didn't survive birth, there is little known about it. Some things can be surmised by Judges wanting to explore a parallel-Earth where the child survived. The child was exhibiting powers even while it was still in the womb (these uncontrolled experiments led to its death). Among the powers it exhibited were Radiation Emission and or Plasma Generation (with Radiation as a side effect). By using Franklin as an example, it can be extrapolated that this child might have possessed even greater powers and achieved them almost immediately upon birth. If the unborn Richards child possessed certain powers such as Free Spirit or Serial Immortality, it may even still be somewhere on Earth-Marvel.

## THE THING

Benjamin Jacob Grimm

F	IN	(40)	Health: 200
A	GD	(10)	
S	MN	(75)	Karma: 50
E	MN	(75)	
R	GD	(10)	Resources: RM
I	GD	(10)	
P	RM	(30)	Popularity: 80

### Ben (human form)

F	EX	(20)	Health: 50
A	GD	(10)	
S	GD	(10)	Karma: 50
E	GD	(10)	
R	GD	(10)	Resources: RM
I	GD	(10)	
P	RM	(30)	Popularity: 10

### KNOWN POWERS:

**Body Armor:** The Thing's epidermis mutated into an organic, rock-like material that gives him Incredible protection against physical and fire-based attacks. It is less effective against energy attacks and provides only Excellent protection. **Super-breath:** As a Power Stunt using his Monstrous strength, Ben can exhale a small windstorm of Excellent intensity. The range is limited to 20 feet, or 2 areas. **Alter Ego:** The Thing is the superhuman version of Ben Grimm and possesses all the powers listed above. If he returns to his normal body, Ben loses all his powers. During the Secret Wars, Ben discovered he had the ability to change back and forth between his two forms. However, after he "killed" his human self, he concluded he'd lost that ability

permanently. The validity of this assumption is as yet unknown.

**TALENTS:** In either form, Ben is a talented pilot who can operate any aircraft or spacecraft of terrestrial design. If he is required to fly an alien ship, he can figure out the controls with a Reason FEAT. His normal Reason rank increases to Incredible when it is applied to flying any air- or spacecraft, human or alien.

The Thing is also an expert brawler. He is skilled in both Martial Arts B and Wrestling.

**CONTACTS:** He has the same group contacts as the rest of the group. In addition, he is a former member of the Unlimited Class Wrestling Federation.

**BACKGROUND:** Ben Grimm was born in poverty in New York's Lower East Side. His alcoholic father, Daniel Grimm, was chronically unemployed. What money the family did have came from Ben's older brother's criminal activities. Daniel Jr. was leader of the Yancy Street Gang until his death in a gang war when Ben was eight. Ben decided it was now his turn to care for the family and joined the gang; he eventually became its leader. His later rejection of the Yancy Street Gang led to a long-standing grudge against him, but the gang's current members, despite many pranks, have come to Ben's aid when he really needs it. After his parents died, Ben was entrusted to his uncle. Dr. Jacob Grimm had lifted himself from the ghetto to become a successful physician. While Ben initially resented his uncle's success, he learned love from him in his first warm family relationship.

Ben was a football star and earned an athletic scholarship to Empire State University. His freshman roommate was a young Reed Richards. That was the start of a long-lasting friendship that forever altered Ben's life. Even then Reed had planned on building a starship; Ben jokingly promised to pilot it for him.

After graduation, Ben joined the U.S. Air Force and became a test pilot. When Reed told him he had finally built his starship, Ben upheld his old promise. He even agreed to take along Reed's girlfriend and her brother... After the crash, Ben was so appalled at his transformation that he chose the degrading name, the "Thing." As the Thing, Ben held a grudge against Reed and continually reminded him of what had hap-

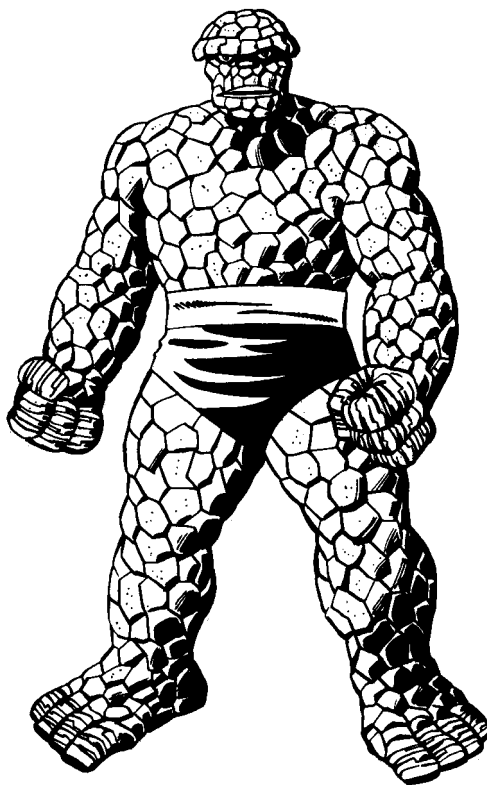

pened. Because of this, Reed spent years trying to reverse Ben's transformation. He completely succeeded once, though Ben was soon returned to his Thing-form as punishment by Galactus. A later attempt returned Ben to an earlier, lumpier Thing appearance. A temporarily adult Franklin Richards returned Ben to his well-known, rocky exterior. During this procedure, Franklin discovered that Ben had a psychological need to maintain his rocky form, knowledge Franklin passed on to his father, who finally felt released from his obligation to cure" Ben.

While on a trip of self-discovery on the battle world of the Secret Wars, Ben unknowingly split into two physically distinct beings, a completely human Ben Grimm and a Ben who could change into the Thing at will. A long duel followed between the two Ben Grimms, in the conclusion of which the Thing "killed" his human self. When he returned to Earth, he discovered that he had always had the ability to switch between his human and Thing selves. Now he believes that since he "killed" his human self, he no longer has that ability.

Although Ben sees himself as a misshapen freak unworthy of any woman's

love, the truth is quite the opposite. A number of women find Ben attractive, including She-Hulk, Tigra, and Thundra.

As leader of the latest Fantastic Four, Ben has matured into a capable, even ingenious hero.

**RUNNING THE THING:** In his early adventures, Ben was moody and quick to anger. He was morose about his condition and complained at the drop of an adamantium hat. After he and Alicia became lovers, Ben began to mellow, although he believed his condition was keeping him from attaining true happiness. With the birth of Franklin, Ben even became downright cheerful. Alicia and Johnny's marriage threatened to destroy Ben's newfound tranquility, but he has since found ways to deal with it.

In battle, the Thing is a relentless berserker who will face self-destruction if it means saving everyone else. His most common oaths are "By my sweet Aunt Petunia" and "It's Clobberin' Time!"

## HUMAN TORCH (II)

Johnny Lowell Storm

F	GD	(10)	Health: 60
A	EX	(20)	
S	GD	(10)	Karma: 26
E	EX	(20)	
R	GD	(10)	Resources: Rm(30)
I	GD	(10)	
P	TY	(6)	Popularity: 50

### KNOWN POWERS:

*Fire Generation:* Johnny's body can emit a fiery energy field of Unearthly rank that completely surrounds his body. He can also create additional blasts of fire from his hands that can hit a target up to 3 areas away. He has developed the power into a number of stunts that he can use effortlessly.

- Skywrite—Johnny can draw any shape in flame. The image lasts 4 turns.
- Nova Flame—Johnny can release his power in a single explosion of Shift-Z intensity. This does 500 points of damage to everything in the immediate area and 150 points worth of damage in each area up to five areas away. When computing damage, the 150 figure refers to the sum total damage done to all targets within the affected area, not to each target. The Nova Flame lasts a single turn, although the subsequent fires may last til they are



extinguished. Once Johnny has expended his flame, all his powers drop to Feeble rank for 1 -10 turns and, unless he makes a red Endurance FEAT, he loses consciousness during that time.

**Energy Sheath:** Johnny can surround any or all parts of his body with a fiery energy field of Unearthly intensity. This provides him with power rank resistance to physical or energy attacks, except for wind-, cold- or water-based attacks. The fiery sheath can be reshaped by his willpower to cover only the body areas Johnny wants covered. For example, in order to carry someone, he would leave his arms fire-free.

**Flame Control:** Johnny has Unearthly control over all forms of flame, whether natural or power-created. He can animate, extinguish, or amplify any fire within one area of his location. He can increase or decrease the Intensity of any flame or heat attack by his own Unearthly rank. He can do this even if he is not aflame at the time. He has developed his Power into a number of Power Stunts.

- **Self-Duplication**—Johnny can create up to 10 duplicates of himself by shaping his flames to resemble his Human Torch appearance. These duplicates last as long as he concentrates on maintaining them.
- Johnny can shape and maintain cages, barriers, and other restraining shapes out of his flames. They last for as long as he concentrates on them, and do Amazing damage to anyone who tries to pass through them.
- **Nova absorption**—If forced to, Johnny can absorb up to Shift-X Intensity heat and flame. He can maintain this extreme energy level for up to ten turns; then he must release it in a Nova Flame.
- **Self-ignition**—If Johnny is having trouble flaming on, he can absorb the heat in his immediate vicinity and use it to kindle his own flame. This drops the temperature in each adjacent area by 30 degrees.

**True Flight:** Johnny can fly with Excellent speed (150 mph). When he does so, he leaves a fiery trail that persists for an additional five turns. This power only functions when he is aflame.

**Specific Resistance (Flame, Heat):** Johnny has Class 1000 Resistance to heat and fire based attacks. This functions no matter which state he assumes.



If he was not aflame beforehand, resisting more than Monstrous heat causes him to flame on automatically.

**WEAKNESSES:** Most of Johnny's powers can be used only if he is aflame. Consequently, anything that inhibits combustion can knock out his powers. Such inhibitors include Cold-based attacks of Shift-X Intensity or removing the oxygen from his environment by immersing him, covering him with an extinguishing substance, or removing all the air from his vicinity.

Depending on the nature and Intensity of the fire-negating attack, Johnny may suffer additional damage as well.

However, wearing an "atmo-web" of Reed's design, Johnny can function in a vacuum or Under the water for several hours at a time.

The flames of the Human Torch can also be disrupted by other flames at precisely the right temperature. Any other character with Fire Generation can upset the Torch's flames (doing Remarkable Force damage) by making a Power FEAT at Unearthly intensity.

**TALENTS:** Johnny is an expert automobile mechanic, an authority on automo-

tive design, and a race car driver.

**CONTACTS:** Johnny Storm is a founding member of the Fantastic Four. He has all the group's affiliations. He counts Spider-man as a special friend, and he has several Contacts in the automobile racing profession.

**BACKGROUND:** Johnny Storm is the younger brother of Sue Storm and the only son of Dr. Franklin and Mary Storm. Despite Mary's death in a car crash when Johnny was very young, he developed a love of automobiles and racing. He spent most of his free time with mechanics and quickly learned to repair and rebuild cars. When he turned 16, his father gave him his first car. Shortly thereafter, when Doctor Storm was imprisoned for murder, Sue told Johnny that their father had died.

Johnny came out to Central City, California, to visit his sister. When he learned that Sue was planning on being a passenger on Reed's starship's maiden flight, Johnny insisted on coming along.

After the creation of the FF, Johnny and Sue returned to Long Island. There he managed to graduate from high school while simultaneously learning to be a super hero. After graduation, Johnny moved with Sue into the Baxter Building. He attended Metro College for a year before dropping out.

He has had a series of romantic flings with various women through the years. Former girlfriends include Dorrie Evans, Crystal, Lorrie Melton, Frankie Raye, Julie Angel, and Sharon Selleck. Although he has known Alicia for years, it was only during Ben's sojourn away from Earth that he and Alicia finally got to know each other. The romance flared quickly. When Ben first discovered what had happened, he almost killed Johnny. Since Johnny and Alicia have married, the Thing has calmed down, although Johnny suspects that Crystal's presence in the latest FF team is one of Ben's ploys to get revenge.

**RUNNING THE HUMAN TORCH:** Johnny Storm began as a brash, hot-headed teen. Now he is a brash, hot-headed adult. His power reflects his personality perfectly. He is prone to action without thought. It is only when he is alone with Alicia that the quiet, introspective side of his personality comes out.



## CRYSTAL

### Crystal Amaquelin Maximoff

F	GD	(10)	Health: 60
A	EX	(20)	
S	GD	(10)	Karma: 26
E	EX	(20)	
R	GD	(10)	Resources: EX(20)
I	GD	(10)	
P	TY	(6)	Popularity: 15 (80 among Inhumans)

#### KNOWN POWERS:

*Elemental Control:* Crystal can control the four classical “elements” of earth, air, water, and fire with Monstrous rank ability. She can maintain a specific effect for up to one hour before fatigue sets in. She has developed the following stunts that she can use without cost:

- Fire Generation of Excellent intensity within five areas.
- Negating fires with Remarkable intensity within five areas.
- Remarkable Weather Control.
- Water Animation—Crystal has the Monstrous ability to move water.,
- Earth Animation—Crystal has the Monstrous ability to move natural soil and rock, create tremors of Amazing intensity, and propel rocks as weapons that do Incredible damage up to 5 areas away.
- Whirlwind—Crystal can make the air transport her and anyone in the same area with Remarkable speed.

**WEAKNESS:** All Inhumans have a Molecular Allergy to compounds found in air pollution. The result is physical incapacitation as the Inhuman becomes extremely ill. Normally, Crystal would have to make a red Endurance FEAT each week she is on Earth. However, Mr. Fantastic has created an antidote which enables the Inhumans to breathe the air without harm.

**TALENTS:** Crystal possesses basic medical skills, primarily First Aid. She can also operate the medical equipment in the FF’s headquarters. As a member of the Inhumans’ Royal House, she possesses Political skills, which give her a +1CS in FEAT rolls dealing with politics.

**CONTACTS:** Crystal is a member of the Royal Family of the Inhumans and a member of the Fantastic Four. While she is technically married to Quicksilver and



therefore related to Scarlet Witch and Magneto, her relations with her husband and in-laws vary widely with time.

**BACKGROUND:** Crystal is the younger sister of Medusa. As a child, her exposure to Terrigen Mists brought forth her powers. When Maximus drove the Royal Family into exile, Crystal first encountered the outside world. There she met and fell in love with Johnny Storm. Crystal assumed Sue’s position in the FF when Sue was pregnant with Franklin. Later, her increasing allergy to New York’s air forced her to leave the group. While heading home, she met Quicksilver and brought him to Attilan. There they fell in love and eventually married.

Shortly after the Inhumans moved their city to the moon’s Blue Area, Crystal gave birth to Luna, a completely human child. Her marriage to Quicksilver disintegrated as he fell into madness. She has now left Attilan to return to the FF, along with her daughter and Luna’s nurse, Maya.

**RUNNING CRYSTAL:** In her early adventures, Crystal resembled a naive country girl just visiting the city for the first time. Even now, she is bound by the conven-

tions and laws of Inhuman society, even if this is to her detriment. While married to Quicksilver, she has changed from an adoring wife to stoic sufferer of his abuse. With her newly declared independence, her days of willing suffering are done.

## MEDUSA

### Medusalith Amaquelin Queen of Attilan

F	RM	(30)	Health: 110
A	RM	(30)	
S	EX	(20)	Karma: 70
E	RM	(30)	
R	GD	(10)	Resources: EX(20)
I	RM	(30)	
P	RM	(30)	Popularity: 15 (90 among Inhumans)

#### KNOWN POWERS:

*Prehensile Hair:* Medusa has the Remarkable rank ability to use her hair like a series of tiny tentacles. Her power is telekinetic in nature; despite its ability to move, her hair is almost identical to normal human hair. However, it is 12 feet long and more resilient than normal (Incredible material strength). Her power enables her to do the following stunts at no cost:

- Handle objects with Incredible Strength and Agility.
- Perform up to three actions simultaneously using her hair alone. However, this requires such concentration that Medusa is unable to perform any concurrent non-hair actions.
- Attack opponents up to one area away at Incredible rank, with Remarkable damage.
- Move along the ground 3 areas per round or Climb at a speed of 2 stories per round.
- Rotate her hair like a propeller to create Excellent intensity winds.

**WEAKNESS:** Like the rest of the Inhumans, Medusa has a Debilitating Molecular Allergy to the chemical pollutants of the industrialized world. She must make a green Endurance FEAT each week she is in the outside world; failure to do so renders her Incredibly ill. Reed has come up with a serum that negates this weakness.

**TALENTS:** Medusa has Martial Arts C when she uses her hair in combat. She is



the only person who can read Black Bolt's body language well enough to understand him; she thus acts as his interpreter to others. (in game terms, there is a one round delay when Black Bolt wants to speak through Medusa to another character.)

**CONTACTS:** Medusa is a member of the Royal Family of the Inhuman race and can call upon any of them for assistance. Since her marriage to Black Bolt, she has become that race's queen. In her earlier adventures, when she was an exile and suffering from amnesia, she became a member of the super-villain team, the Frightful Four. When she regained her memory and then later joined the FF, she and the remaining Frightful Four (er, Three) became foes.

**BACKGROUND:** Medusalith Amaquelin is the daughter of nutritionists Quelin and Amber, the older sister of Crystal, and the second cousin of Black Bolt. She was born into the Royal Family of Attilan. Her exposure to the Terrigen Mists as an infant gave her well-developed hair and the psionic skills to handle it. When she was young, she visited the confined Black Bolt and learned to understand

him. Since that time she has always served as the royal interpreter. Their constant companionship eventually turned into love and marriage.

When Maximus forced the Royal Family into exile, she lost her memory in an air crash that separated her from the rest of the group. She wandered Europe and used her power to commit petty theft to survive. In Paris she was found by the Wizard, who recruited her as "Madame Medusa" into his new supervillain team, the Frightful Four. Eventually the rest of the Royal Family found her and restored her memory. Since that time, she has always been at Black Bolt's side except for short journeys to the outside and for two extended periods. The first was when she replaced Sue in the Fantastic Four (Sue and Reed were separated at the time). The second was when she was kidnapped by the criminal organization, the Enclave.

**RUNNING MEDUSA:** Medusa is a fiercely loyal member of the Royal Family. She is a firm friend of the FF and will do anything to help them so long as it does not harm Attilan's interests. When she was a member of the Frightful Four, her motivations were gratitude to the Wizard for rescuing her and boredom from a lack of anything better to do. Following her return to the Royal Family, she now sees that team as an annoying embarrassment from her past.

## POWER MAN

**Luke Cage**

F	RM	(30)	Health: 130
A	GD	(10)	
S	IN	(40)	Karma: 36
E	AM	(50)	
R	GD	(10)	Resources: PR(4)
I	EX	(20)	
P	TY	(6)	Popularity: 18

### KNOWN POWERS:

**True Invulnerability:** The density of Cage's body tissue has been artificially amplified. The result is that Cage's body has the natural equivalent of Incredible rank armor plate, both inside and out. He can resist extremes in temperature from -100 to 2850 degrees Fahrenheit and electric shocks of 30,000 volts.

**Regeneration:** Cage has Poor rank self-healing ability and can heal three times as fast as a normal person.



**TALENTS:** Having experience on both sides of the law gives Cage both Law Enforcement and Criminology skills. His partnership with Iron Fist gave him the opportunity to learn Martial Arts A and E.

**CONTACTS:** As a temporary member of the Fantastic Four, Cage can call on the team anytime. He was partners with Iron Fist in a "hero-for-hire" agency, and still works closely with Nightwing Restorations, the detective agency run by Misty Knight and Colleen Wing.

**BACKGROUND:** "Luke Cage" experienced a deprived childhood in Harlem where he often committed petty crimes with his buddy Willy Stryker. As they grew up, they grew apart. Cage tried to find honest work while Stryker became a professional criminal. Their rivalry for the woman Reva Connors finally drove them apart. Stryker framed Cage for drug dealing. Reva was killed shortly afterward in a hit intended for Stryker. From Seagate Prison, Cage vowed revenge on Stryker. His anger grew; he frequently got into trouble for fights and escape attempts. Even his parole hearings tended to end in violence.

Dr. Noah Bernstein, a research physiologist with a grant from Stark International, came to Seagate to try a medical experiment on the inmates. He was developing a treatment that would increase cellular regeneration to fight aging and disease. Bernstein found Cage to be an ideal subject and even came to sympathize with his plight.

While Luke was undergoing treatment, a corrupt guard tampered with Bernstein's equipment in the hope of killing Cage. Instead he exceeded the experiment's limits and achieved undreamed of results. Now in possession of superhuman strength and invulnerability, Cage attacked his would-be killer and escaped the prison. The fugitive Cage made his way to NYC under a variety of assumed names. When he foiled a robbery attempt at a diner and received a cash reward from the owner, Cage decided to become a superhero mercenary. The business was slow at first and involved defending clients against a variety of mob low-lives. Eventually he hooked up with Nightwing Restorations and began to make decent wages. For a time, he was partners in the Heroes For Hire Agency with Iron Fist. Along the way, Cage was hired by Reed to substitute in the FF for a human Ben Grimm. Ben thought that Cage was his permanent replacement and was extremely hostile toward him. However, Ben later learned that Cage's tenure was only to last until Reed could finish building a Thing-exoskeleton that would enable Ben to resume his place with the FF

**RUNNING POWER MAN:** Cage is a large, dangerous-looking individual and knows it. He knows everyone else knows it too and thus he does not have to speak too much. He lets body language handle most of the talking. He favors the simple brute force approach to problems. If he is wronged, he has been known to hold a grudge and go to great lengths to exact justice.

## SHE-HULK

### Jennifer Walters

F	RM	(30)	Health: 175
A	EX	(20)	
S	MN	(75)	Karma: 36
E	AM	(50)	
R	TY	(6)	Popularity: 30
I	GD	(10)	
P	EX	(20)	Resources: Ex(20)

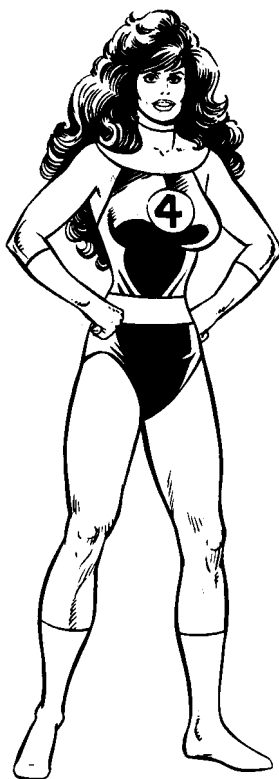

### KNOWN POWERS:

**Body Armor:** She-Hulk's emerald skin is the equivalent of Incredible Body Armor and provides her with Excellent protection from energy attacks.

**Hyper-Leaping:** Her increased leg muscles give She-Hulk Shift Z Leaping ability. She can cross four areas with a single bound.

**Alter Ego (lost):** The She-Hulk body is secondary to her original body of Jennifer Walters. Originally, she could return to her Jennifer-self whenever she chose to do so, and automatically reverted if she was exposed to a strong dose of gamma radiation. She-Hulk spent less and less time as Jennifer and finally chose to remain emerald green full time. In an adventure since making that decision, she has lost the ability to revert to her human form. Her stats as Jennifer were:

F	A	S	E	R	I	P
TY	TY	PR	GD	GD	GD	TY

**TALENTS:** Jennifer was a lawyer and a member of the California Bar. She still retains her full legal training although she rarely has a chance to employ it. She is also trained in Martial Arts C.

### CONTACTS:

Her major contacts are with the Fantastic Four, the Avengers (She-Hulk is the first person to hold concurrent memberships in both groups), and her cousin Bruce Banner. Her father is Sheriff of Los Angeles County.

**BACKGROUND:** Attorney Jennifer Walters was mortally wounded by mobsters. An emergency blood transfusion from her cousin Bruce Banner saved her life, but it also gave her a variation of his Hulk persona and powers. Fortunately, Jennifer retained her normal mind, even when she was in her own Hulk-body.

**RUNNING SHE-HULK:** She-Hulk is an easy-going, fun-seeking hero. She is completely at ease with her new condition. She acquires friends easily and remains devoted to them. In the case of Wyatt Wingfoot, the devotion is much stronger. She is also an implacable foe to anyone who harms her friends.

## MS. MARVEL II

Sharon Ventura

F	IN	(40)	Health: 140
A	EX	(20)	
S	IN	(40)	Karma: 18
E	IN	(40)	
R	TY	(6)	Resources: TY(6)
I	TY	(6)	
P	TY	(6)	Popularity: 10

### KNOWN POWERS:

**True Invulnerability:** Sharon has Incredible Resistance to any physical or energy attack.

**Regeneration:** With Poor Regeneration, Ms. Marvel heals three times as fast as a normal person.

**WEAKNESS:** Sharon has a pathological hatred and fear of men. This requires a Psyche FEAT roll whenever she fights a male. A green result (or a yellow result if Ben is threatened) indicates that she has gone into a berserk fury. A white result indicates that Sharon has collapsed into catatonia for 1 -10 rounds.

**TALENTS:** Sharon is trained in Martial Arts C and Wrestling.

**CONTACTS:** Sharon is a member of the Unlimited Class Wrestling Federation,



# FRIENDS OF THE FF



where she met Ben. She is the newest member of the FF.

**BACKGROUND:** Sharon Ventura was a tall, extremely athletic woman who decided to earn a living as a wrestler. While on the California wrestling circuit, she met Ben and immediately became attracted to him. She decided she needed super-powers to win him. She learned of the Power Broker's offer to augment people's strength for straight cash fees and accepted. Now super-strong, she felt so protective of Ben that she saw his old friends as potential adversaries. She even fought She-Hulk when Jennifer had located Ben at last. Ben quietly slipped away during the battle. Sharon was upset both at that and her discovery that the Power Broker's treatment had left her chemically and mentally dependent on him. She decided to destroy the Power Broker's operation. Instead, she was betrayed by her boyfriend, Lt. Mike Lynch, and captured. Power Broker's main scientist, Dr. Karl Malus, put Sharon in restraints and began a series of experiments to strip away her powers. During this time she was also subjected to brutal abuse by his assistants, with the result that she developed a severe ha-

tred toward men. After she and Captain America destroyed Malus' operation, she came to the East Coast to begin her life anew. When she defeated Diablo's latest attempt to slay the FF, Ben asked her to join his new FF team.

Ben has not told anyone that Sharon is a twin to Tarianna, his female self he encountered on the Secret Wars' battle-world. Ben's grief over his inability to save her has been transformed into the resolve to save Sharon.

**RUNNING MS. MARVEL:** Sharon is a pathetic, confused woman who wants to be strong and self-determined but does not know what to do. Her strongest conviction is her attraction to Ben.

Subconsciously, she does not see Ben as a man, at least not like other men "with their moustaches and brutal hands." It remains to be seen if Ben's guidance can heal her psychological scars.

## FRANKIE RAYE (pre-Nova)

F	GD	(10)	Health: 56
A	EX	(20)	
S	TY	(6)	Karma: 20
E	EX	(20)	
R	GD	(10)	Resources: TY(6)
I	PR	(4)	
P	TY	(6)	Popularity: 50

### KNOWN POWERS:

*Fire Generation:* Frankie can generate Monstrous rank flame from any part of her body. Her powers are similar to those of her tutor, the Human Torch, although she lacks his experience and imagination.

*Fire Control:* Frankie has Monstrous control over any flame, whether it was natural or power-created. She has no control over the Human Torch's flame and neither has he any power over hers.

*Energy Sheath (Fire):* Frankie can surround her body with a fiery sheath that gives her Monstrous rank resistance to physical attacks and high temperatures. Objects of less than Incredible material strength immediately melt or burn upon touching her. Living targets suffer Incredible damage if they are not somehow protected from her heat.

*True Flight:* Frankie can attain Excellent airspeed. Because her power is based on combustion, she cannot travel in an



oxygen-less environment.

**CONTACTS:** Frankie was a temporary member of the Fantastic Four during her short career. If the circumstances allow, she could call on her long-vanished stepfather Thomas Raye (Prof. Phineas Horton) or his creation, the original Human Torch, for help.

**BACKGROUND:** Frankie Raye was the stepdaughter of Thomas Raye, also known as Prof. Phineas Horton, the creator of the original Human Torch. When the FF appeared, Horton became angered that another should be using the identity of his creation. He took his stepdaughter to an abandoned warehouse where he had stored his chemicals and equipment. Presumably he intended to create a new android. Instead, a decaying barrel dumped its contents on Frankie. Within seconds the chemicals permeated and transformed her body. She turned into a living ball of flame. When Raye managed to calm Frankie down, she reverted to her normal appearance. Anguished over what he had done, Horton hypnotized her into forgetting her powers. He also gave her an aversion to flame and a series of post-

hypnotic suggestions that allowed him to secretly aid her later. He then abandoned her, naked except for his raincoat. Each month in the years that followed, Horton sent her an envelope with enough cash for her to get by on. He even sent her a costume that blended into her skin and would only appear if she was otherwise nude. Post-hypnotic suggestions made her forget the costume's existence and develop a dislike of seeing her own body.

The money stopped when Horton died. Frankie was now an adult who had begun to date Johnny. Her continual exposure to him destroyed the memory blocks and enabled her to finally use her powers, which were similar to his. She was a member of the FF until Galactus died and was revived by Reed. Although frightened by Galactus, she realized he would need a new Herald to find suitable worlds on which he could feed. Otherwise, he would be forced to feed on the Earth's life-force. Galactus accepted her offer and transformed her into Nova (see Galactus' Heralds).

**RUNNING FRANKIE RAYE:** Before she regained her memory and powers, Frankie was a strong-willed, somewhat short-tempered woman. Her powers only increased her tendency to overreact to a given situation. For example, she almost incinerated a young girl's abusive drunk of a father.

## WYATT WINGFOOT

F	GD	(10)	Health: 20
A	GD	(10)	
S	GD	(10)	Karma: 26
E	GD	(10)	
R	GD	(10)	Resources: GD(10)
I	GD	(10)	
P	TY	(6)	Popularity: 35

**KNOWN POWERS:** None.

**TALENTS:** Wyatt is a superb athlete, mechanic, and engineer. He shares responsibility with Johnny for maintenance and improvements done to the FF's vehicles. He is a natural expert on Amerindian culture and folklore, especially in regards to the Comanche and Keewazi tribes. Because of the time he has spent with the FF, he has become an expert in their various systems and devices.

**CONTACTS:** Wyatt is a longtime friend of the FF in general and Johnny Storm in particular. His relationship with She-Hulk is much closer. Wyatt is a former chief of the Keewazi Tribe and still commands their respect despite his abdication.

**BACKGROUND:** Wyatt Wingfoot was born on the Keewazi Indian Reservation in Oklahoma. The Keewazi are an offshoot of the Comanche people and represent a blend of tradition and modernity. While they still retain ancient cus-

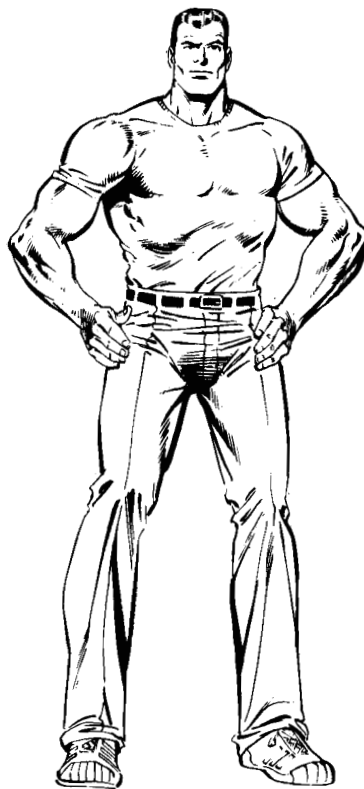

toms, they possess a wealth of modern technological devices. The tribe is fairly affluent due to the oil reserves found under their land.

Wyatt's father was Will Wingfoot, a famous athlete and decathlon champion, and his grandfather was Silent Fox, a tribal Chief and medicine man. Will died years before Wyatt came to NYC, but it was his influence that led Wyatt to attain a degree and wide knowledge of the outer world.

Wyatt entered the FF's lives when he was Johnny's college roommate during their freshman year at Metro University. The friendship between the young men inevitably drew Wyatt into the FF's adventures. He remained friends even after Johnny dropped out after his sole college year. Wyatt's brilliant mind and dedication to learning propelled him swiftly through academia; he received his Bachelor's degree in record time.

Wyatt got the FF to assist his tribe when it was attacked by a Roxxon robot masquerading as their tribal god Tomazooma. He reciprocated by helping Johnny search for the then-unknown location of Attilan, hidden in the Himalayas. Wyatt later helped the FF defeat the Miracle Man.

Years elapsed before Wyatt again rejoined the FF. He spent that period teaching tribal children and assuming more leadership responsibilities as Silent Fox grew frail. Silent Fox eventually died, forcing Wyatt to assume the duties of Chief. However, the day Wyatt

was to become chief was also the day Terminus arrived on Earth. In the following struggle, Wyatt realized he could not limit himself to life with the Keewazi.

Of course, he did gain the fringe benefit of being able to get close to She-Hulk on a regular basis. Their friendship began immediately and soon got much more intimate. In fact, Wyatt was soon spending more time with She-Hulk than with the rest of the FF combined. When She-Hulk eventually left the FF, Wyatt went with her.

**RUNNING WYATT WINGFOOT:** Wyatt is a strong, resourceful, and even-tempered person. He never displays anger or other negative emotions. On the other hand, he still possesses an active sense of wonder; he is thrilled at each new discovery he makes, especially when he is with the FF. While he is a physically powerful man, he rarely uses his strength if a mechanical solution is available.

## TATTLETALE

Franklin Benjamin Richards

F	PR	(4)	Health: 16
A	TY	(6)	
S	FE	(2)	Karma: 91
E	PR	(4)	
R	TY	(6)	Resources: FE(2)
I	GD	(10)	
P	MN	(75)	Popularity: 10

### KNOWN POWERS:

In the past, Franklin has exhibited powers that would make him a demigod. When he had temporarily transformed himself into an adult, Franklin decided that he should deny himself his powers until he was old enough to properly use them and placed them under a psychological block. However, some powers have emerged.

**Precognition:** Franklin has Amazing rank Precognition that operates only when he is asleep. He calls them "his funny dreams." Reed and Sue have learned to worry when the funny dreams appear, since they have the potential to come true.

**Self-Duplication (Illusory):** When Franklin is asleep he can release an intangible but visible copy of himself. He can also use this power when awake if he succeeds in a yellow Psyche FEAT roll. The "dream body" can go instantly to any location Franklin thinks about. The power has Class 5000 rank; this enables him to send his dream body up to 250 miles away.

Franklin can see and hear everything the Dream body experiences. When he uses the power, Franklin talks in his sleep; this allows anyone watching his sleeping form to somewhat monitor the situation. Franklin automatically uses Telelocation in conjunction with this power; this enables him to automatically locate anyone he's thinking about. Because of the power's high rank, the dream body is virtually

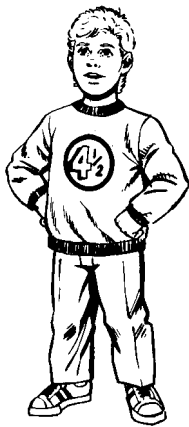

indestructible. Besides, the only powers that could even begin to affect it are those that affect psionic or magical powers.

**Telelocation:** Franklin has the Incredible rank ability to mentally locate anyone he thinks about. The maximum range for this is 250 miles, the same as his “dream body’s” range. This power is linked to his “dream body” and only functions when Franklin is using Self-Duplication.

**Biophysical Control (Disruption):** When freed of his psychological blocks, Franklin has demonstrated the Incredible rank power to cause a victim intense pain. The power is accompanied by a purple-white glow in his eyes. The pain is physically crippling during its effect. Victims can recover by making a yellow Psyche FEAT (try once per minute). If Franklin uses this against a cybernetic victim, the target may even explode (alas poor Herbie).

**TALENTS:** None.

**CONTACTS:** Franklin is the child of Reed and Sue Richards, founders of the Fantastic Four, and shares most of their Contacts. His best friends are the Powers children (a.k.a. the Power Pack), with whom he secretly goes on adventures. While she was alive, Franklin had close ties to his nanny, Agatha Harkness. Although she is currently dead, perhaps the tie extends beyond death.

**BACKGROUND:** Franklin’s troubles began in

the womb, when the combination of his parent’s mutated DNA gave Franklin the potential for tremendous power. It was a difficult pregnancy due to imbalances in Sue’s bloodstream; both mother and child almost died during the delivery. Franklin developed quickly from being a babe in arms to an independent preschooler. Franklin always behaved as a normal child; his exotic home life seemed perfectly normal to him. However, when Franklin was three, he started to exhibit previously unsuspected mutant powers. The first to appear was his ability to cause great pain in a target. Ben was the first to experience this when Franklin tried it as a way to wake him up. Franklin’s powers began to mushroom out of control, forcing Reed to take the drastic step of temporarily lobotomizing his son. Later Franklin returned to normalcy and, a bit after that, his powers began to reappear. In a burst of anger, Franklin restructured the puzzle he was working on, blew up Herbie II, and turned himself into an adult.

When Franklin returned to being a child, he no longer had his powers. However, the block that prevents his powers from manifesting themselves only functions when Franklin is in his real body. As Mephisto discovered, Franklin’s astral body has all of his powers. Franklin’s less destructive powers have recently begun to reappear. Reed has finally realized that continually destroying Franklin’s powers is not the solution; he has begun to teach his son the proper way to use his powers.

**RUNNING TATTLETALE:** Despite his exotic background, Franklin is pretty much an average kid. He likes to adventure and to be liked by adults, although he doesn’t understand most of them. He does have a lot of self control (probably learned from his parents who would have worried about him, say, accidentally opening the Negative Zone portal).

## ALICIA REISS MASTERS STORM

F	PR	(4)	Health: 18
A	TY	(6)	
S	PR	(4)	Karma: 40
E	PR	(4)	
R	GD	(10)	Resources: TY(6)
I	GD	(10)	
P	EX	(20)	Popularity: 20

**KNOWN POWERS:** None.

**TALENTS:** Alicia is one of the leading Neo-Realist sculptors in the world today. Her realistic yet romantic portrayals of the world’s superhumans have earned her household name status and great popularity.

**CONTACTS:** Alicia is an integral member of the Fantastic Four’s extended family, both



through her long courtship with Ben and her marriage to Johnny. Curiously, her art also gives her a tenuous link to Dr. Doom, who admired her skill enough to make her do a sculpture of him. She is the stepdaughter of the Puppet Master, who remains devoted to her (even if he does try periodically to kill her lovers).

**BACKGROUND:** Alicia was blinded when she was 15. Her stepfather, Philip Masters (the Puppet Master) blamed himself for her condition. She didn’t leave their apartment for the next three years, during which time she developed the Sculpting skills she learned from her stepfather. When a battle between the Puppet Master and the FF brought the Thing into her home, she immediately was drawn to Ben. The romance took form between the ill-educated, brutish Ben and the delicate, artistic Alicia, lasting for years. Unfortunately; Ben’s delusion that she loved only the Thing and not Ben himself kept him from fully loving her. Eventually he became so frustrated that he left Alicia and the Earth for several months. During that time, Alicia and Johnny fell in love. When Ben returned, Alicia convinced the angry Thing that they would always be friends. Although Ben still regrets losing her, he remains her friend.

**RUNNING ALICIA:** Alicia is a gentle woman who has never been known to hit anyone, even when she is being attacked. She knows



she is often the tool for foes wishing to strike at the FF, but she continues on with her life as best she can. She is devoted to Johnny, but always retains a special affection for Ben. As a side note, she apparently has memorized most of Manhattan and can get about the city as easily as can an out-of-town visitor.

## AGATHA HARKNESS

F	PR	(4)	Health: 20
A	TY	(6)	
S	PR	(4)	Karma: 116
E	TY	(6)	
R	EX	(20)	Resources: GD(10)
I	EX	(20)	
P	MN	(75)	Popularity: 10

### KNOWN POWERS:

*Ritual Magic:* By combining specific chants and gestures, Agatha can create magical effects of up to Monstrous power. These effects can simulate the effects of a number of powers; each power is treated as a Power Stunt that she can use easily:

- Force Field
- Force Field v. Hostiles
- Force Field v. Magic
- Reflection
- Resistance to Magic
- Extradimensional Detection
- Life Detection
- Magic Detection
- Power Detection
- Psionic Detection
- Biophysical Control (Healing)
- Biophysical Control (Disruption)
- Hypnotic Control
- Mind Control
- Neural Manipulation
- Shapechange Others
- Summoning
- Magic Control
- Magic Domination
- Sympathetic Magic
- Communicate with Animals
- Communicate with Plants
- Dreamtravel
- Empathy
- Free Spirit
- Sensory Link
- Telepathy
- Dimension Travel
- Gateway

**TALENTS:** Agatha is fully trained in the arcane arts due to her Mystical origin. She is an expert in Occult Lore and can identify any magical artifact with Monstrous ease (a green FEAT).

**CONTACTS:** Agatha was Franklin Richards' governess when he was an infant and toddler and therefore had strong bonds with the FF. Her background with the New Salem Witches was less firm. Although she was a leader of



their colony, she became estranged from them when she returned to the outside world.

**BACKGROUND:** Agatha Harkness was the greatest sorceress from the witch colony of New Salem, Colorado. She was the "Grande Dame" of the community for a long time, but eventually she grew restless and returned to the outside world. She built her home of Whisper Hill in the Adirondack Mts. of upstate New York. She became aware of the infant Franklin's existence and powers and decided that she should offer her services as his governess. When Reed and Sue learned of her powers, they agreed; they had been seeking someone who could fill the post of both nanny and protector. Agatha proved she could do both when she defeated the three members of the Frightful Four. Whisper Hill was later destroyed.

Agatha and Franklin were forcibly brought to New Salem by her son, Nicholas Scratch, who placed her on trial for consorting with the outside world. The FF came to her rescue and defeated Scratch and his villainous children the Salem's Seven. Agatha exiled Scratch to Limbo.

Later the Salem's Seven seized power in New Salem and executed Agatha by burning her at the stake. However, Agatha's spirit still lives on in disembodied form. She directed the Scarlet Witch to New Salem, where they fought the Salem's Seven and apparently destroyed the entire community.

In her final encounter with the Scarlet Witch, Agatha summoned her to the mystical dimension ruled by Samhain. There Agatha had been bound to an ethereal stake. The Scarlet Witch eventually freed her and permitted Agatha to claim her eternal rest.

**RUNNING AGATHA:** When Agatha was alive, her main concerns were countering the effects of evil magic on the world and properly rearing young Franklin. At times, her pursuit of these goals seemed to run contrary to the wishes of the FF. She was also concerned with the welfare of her student, the Scarlet Witch, and constantly strove to make things easier for her. Perhaps her hostile relationship with her own son, Nicholas Scratch, is the cause of her strong maternal feelings toward those she "adopted" as her children. This concern continued even when Agatha became a ghost.

## LUNA

### Luna Maximoff

F	FE	(2)	Health: 12
A	FE	(2)	
S	FE	(2)	Karma: 6
E	TY	(6)	
R	FE	(2)	Resources: Shift 0
I	FE	(2)	
P	FE	(2)	Popularity: 20

**KNOWN POWERS:** None.

**TALENTS:** None.

**CONTACTS:** Luna is the daughter of Pietro (Quicksilver) and Crystal, niece of the Scarlet Witch and Vision, and the granddaughter of Magneto. If she's in trouble, her relatives will come to her aid; these relatives include the Inhumans, the FF, the Avengers, and the various mutant groups under Charles Xavier and Magneto's guidance.

**BACKGROUND:** Luna is the first child born on the moon in mankind's history. She is the hybrid of a second-generation mutant (Quicksilver) and a chemically-mutated Inhuman (Crystal). Somehow the different natures of her parents' genes cancelled out whatever powers she might have otherwise inherited. Quicksilver anguished over having a "mere human" for a daughter and sought to expose her to the mutation-inducing Terrigen mists. Ben, Crystal and Lockjaw, stopped him and made him realize that Luna's composite DNA might go terribly awry if he had tried to mutate it. Since that time, Luna's parents have separated, although they remain technically married under Inhuman law. Crystal took her daughter with her to Earth. Luna and her mother now live in Four Freedoms Plaza.

**RUNNING LUNA:** Luna is a typical infant, her

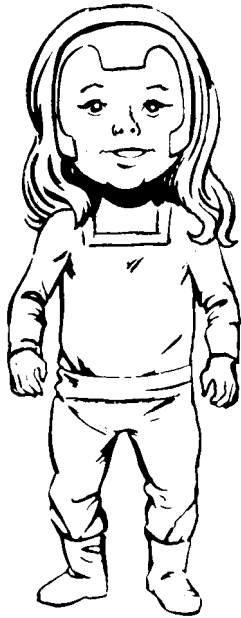

only difference being that she is unafraid of otherwise frightening sights, such as Lockjaw or the Thing.

## MAYA

F	TY	(6)	Health: 28
A	TY	(6)	
S	TY	(6)	Karma: 26
E	GD	(10)	
R	TY	(6)	Resources: GD(10)
I	GD	(10)	
P	GD	(10)	Popularity: 20

### KNOWN POWERS:

**Micro-Environment:** Maya has the Amazing rank ability to change the weather in a small area. When her power functions, the air's composition and temperature change to match that of Attilan. This makes Maya the ideal nanny for Luna, who might otherwise suffer the consequences of breathing New York's air.

**TALENTS:** As a nanny, Maya possesses basic medical skills (First Aid and simple diagnoses).

**CONTACTS:** Maya is an Inhuman in the employ of the Royal house and can call on the Inhumans for assistance, especially if Luna or Crystal are in trouble. Her current assignment makes her a part of the Fantastic Four's extended family as well.

**BACKGROUND:** Maya is a typical Inhuman. Her training as a nanny combined nicely with her power of Micro-Environment when Black Bolt sought someone to aid Crystal in rearing Luna on Earth. She is the first hired servant to live in the FF's headquarters.

**RUNNING MAYA:** Maya is on Earth for one reason: to care for the young Luna. She will not actively engage in any battles involving the FF unless Luna's safety is in question.

## H.E.R.B.I.E.

**Humanoid Experimental Robot, B-Type, Integrated Electronics**

F	GD	(10)	Health: 115
A	EX	(20)	
S	GD	(10)	Karma: 42
E	MN	(75)	
R	EX	(20)	Resources: Shift 0
I	EX	(20)	
P	FE	(2)	Popularity: 6

### KNOWN POWERS:

**Robot Body:** H.E.R.B.I.E. is the name for a series of robots built by Reed to assist him. The H.E.R.B.I.E. series has a Usufirm body; that is, one that is designed to meet its functional needs rather than to meet aesthetic ones. He possesses eight retractable tentacle-like probes and a variety of sensory and defensive devices. H.E.R.B.I.E. possesses human-like intelligence and communication skills.

**Communication with Cybernetics:** H.E.R.B.I.E. is programmed to communicate with any device of at least Feeble intelligence. His Monstrous ability even enables him to communicate with alien computers, such as the Living Computers of Xandar.

**Plasma Generation:** H.E.R.B.I.E. can emit a plasma blast of Monstrous intensity. The beam is a coherent field of glowing, highly-charged particles that possesses a terrific punch when it strikes a target. The beam can do Monstrous rank damage against a non-living target or Remarkable damage to a living target. It has the side effects of providing Incredible intensity illumination and electrical shock. The beam has a maximum range of only one area. **infravision:** H.E.R.B.I.E. can see Infrared light. **Levitation:** H.E.R.B.I.E.'s built-in anti-gravity drive gives him Feeble Levitation. He can hover in place or travel at 3 areas/stories per round. He can also lift an additional 50 pounds.

**Rocket:** H.E.R.B.I.E. has a set of external jets that permit him to fly at Typical speed. This permits him to fly at 6 areas/stories per round in an atmosphere or 75 areas per round in a vacuum. It also enables him to lift an additional mass of 200 pounds.

**TALENTS:** H.E.R.B.I.E.'s skills are limited to whatever programs Reed feeds into him. If the

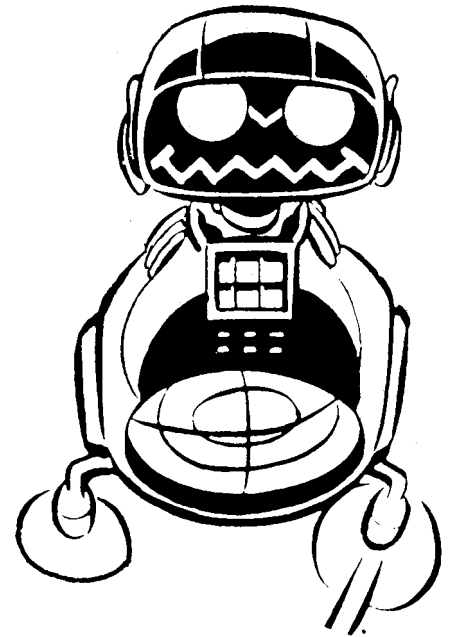

software is available, H.E.R.B.I.E. can function as an expert on any field Reed chooses. The original H.E.R.B.I.E. was primarily used as a scientific tool. The second H.E.R.B.I.E. acted as a sitter and power monitor for Franklin.

**CONTACTS:** H.E.R.B.I.E. is owned by the FF. During the brief time he was possessed by the mind of Dr. Sun, H.E.R.B.I.E. could presumably have commanded Dr. Sun's forces.

**BACKGROUND:** H.E.R.B.I.E. is a series of robots built by Reed to assist him in his scientific endeavors. The original H.E.R.B.I.E. mostly stayed in the Baxter Building's lab or accompanied the FF on space flights. While on a trip to Xandar, the FF were allowed to link H.E.R.B.I.E. with the Living Computers. Unfortunately, everyone was unaware that the disembodied mind of Dr. Sun was lurking in there. Dr. Sun invaded and overwhelmed H.E.R.B.I.E.'s personality. Once back on Earth, Dr. Sun/H.E.R.B.I.E. attempted to destroy the FF. H.E.R.B.I.E. regained its intelligence when Dr. Sun transferred his own mind into the FF's master computer. In order to save the FF and to prevent Dr. Sun from repossessing it, H.E.R.B.I.E. crashed into the Master Computer, destroying everything. When Franklin began to exhibit a resurgence of his powers, Reed built a second H.E.R.B.I.E. This one lacked the first's offensive powers and was programmed to assist Franklin's language development and to monitor Franklin's



powers. The second H.E.R.B.I.E. exploded when a sudden surge of Franklin's powers suddenly aged the boy into an adult. Reed has since built additional robots of this series and uses them throughout the FF's headquarters, where they perform routine monitoring and assistance duties.

**RUNNING H.E.R.B.I.E.:** H.E.R.B.I.E. is a robot and does whatever it is programmed to do. Its programming gives it some free will, though. Both versions of the robot developed an antagonistic relationship with Ben. It was only when H.E.R.B.I.E. was possessed by Dr. Sun that it actually harmed anyone.

## DR: JACOB GRIMM

F	FE	(2)	Health: 20
A	GD	(10)	
S	FE	(2)	Karma: 40
E	TY	(6)	
R	EX	(20)	Resources: EX(20)
I	GD	(10)	
P	GD	(10)	Popularity: 25

**KNOWN POWERS:**  
None.

**WEAKNESSES:** Dr. Grimm's legs are weak. He requires crutches to get around, and has Feeble Agility for purposes of attacking or dodging.

**TALENTS:** Jake is a licensed general practitioner and a former medical instructor. He has both Medicine and First Aid talents.

**CONTACTS:** He has strong ties to the FF, particularly the Thing, and to the people still in Benson, Arizona.

**BACKGROUND:** Jacob Grimm was born in poverty in NYC but used his intelligence to pull himself out of the ghetto. While he was unable to get his brother to do likewise, he at least

was able to watch out for his nephew, Ben. When Ben's parents died, Jacob and his wife Alyce adopted him and raised him through adulthood. Late in life, Jacob was partially crippled by a car crash that killed Alyce. While he was convalescing, he returned to teaching medicine. There he met Penny, the student who eventually became his wife and colleague. After the creation of the FF, he and Penny moved from NYC to Benson, AZ, where they established a general practice.

**RUNNING DR. GRIMM:** Jacob Grimm is a compassionate and extremely competent doctor.

## DR. PETUNIA "PENNY" GRIMM "Aunt Petunia"

F	TY	(6)	Health: 28
A	GD	(10)	
S	TY	(6)	Karma: 30
E	TY	(6)	
R	GD	(10)	Resources: GD(10)
I	GD	(10)	
P	GD	(10)	Popularity: 10

**KNOWN POWERS:**  
None.

**TALENTS:** Aunt Petunia is a licensed general practitioner. She has both Medicine and First Aid skills. She also knows Martial Arts B.

**CONTACTS:** She has a strong contact with the FF and the Thing in particular.

**BACKGROUND:** Penny Grimm is the second wife of Dr. Jacob Grimm, Ben's uncle. She and Ben have a fondness for each other, with the result that Ben uses her name as one of his milder oaths. Shortly after the creation of the she and Jake left NYC to set up a rural practice in Benson, Arizona.

**RUNNING AUNT PETUNIA:** Penny is a strong-willed woman who is fiercely protective of her husband, her adopted family, and her patients.

## DORRIE EVANS

PR	(4)	Health: 22
TY	(6)	
TY	(6)	Karma: 18
TY	(6)	
TY	(6)	Resources: TY(6)
TY	(6)	
TY	(6)	Popularity: 5

**CONTACTS:** Johnny Storm is her main contact.

**BACKGROUND:** Dorrie Evans was Johnny

Storm's first serious girlfriend. They began dating when he moved to Long Island and transferred to her high school. They continued to date when she went off to college. However, their lives were going in different directions and they split up.

**RUNNING DORRIE:** If an adventure is set during the time Dorrie and Johnny were still dating, treat her as a normal teenage girl from a decade ago.

## LORRIE MELTON

F	GD	(10)	Health: 32
A	TY	(6)	
S	GD	(10)	Karma: 26
E	TY	(6)	
R	GD	(10)	Resources: GD(10)
I	GD	(10)	
P	TY	(6)	Popularity: 7

**TALENTS:** Lorrie is a talented auto Mechanic and is knowledgeable in the field of auto racing (+1CS to Reason FEATS involving automotive engineering and any Resource FEATS for building race engines).

**CONTACTS:** Johnny Storm is an ex-boyfriend.

**BACKGROUND:** Lorrie followed her father's footsteps and became a racecar mechanic. When Johnny hired her father's team as his pit crew, he and Lorrie met. They had a brief romance until Lorrie decided that she didn't fit into the world of the FF.

**RUNNING LORRIE:** Lorrie is an adventurous woman who likes reasonably safe forms of adventure.

## JULIE ANGEL Juliette D'Angelo

F	TY	(6)	Health: 28
A	GD	(10)	
S	TY	(6)	Karma: 22
E	TY	(6)	
R	TY	(6)	Resources: TY(6)
I	TY	(6)	
P	GD	(10)	Popularity: 30

**TALENTS:** Julie is an actress and model.

**CONTACTS:** Julie is an ex-girlfriend of Johnny Storm. Their parting was amicable. She was originally roommates with Frankie Raye before that woman became Nova, Galactus' Herald.

**BACKGROUND:** Julie realized that her good looks, personality, and basic acting skills could be used to get her fame and fortune, so she moved to New York to be an actress or model (whichever would pay the better). She couldn't afford a place of her own so she shared an



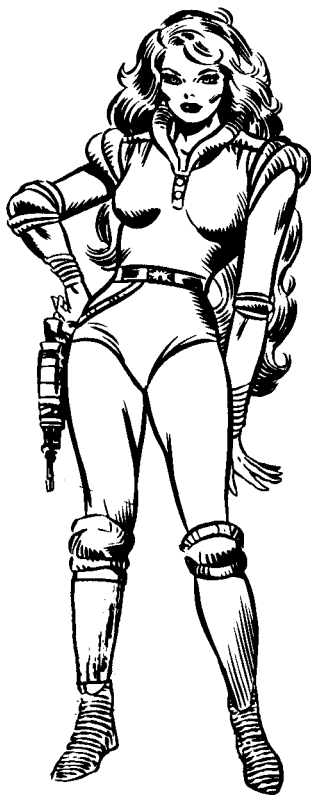

apartment with Frankie Raye. Through her she met Johnny Storm and the rest of the FF. When Frankie became Nova and left Earth, Julie moved in on the heartsick Johnny. Their relationship never developed seriously, though, and eventually she transferred her affections to Grey Landers, another actor. When Grey got a job in Hollywood, Julie followed him there.

**RUNNING JULIE:** Julie is an extremely pleasant airhead.

## SHARON SELLECK

F	TY	(6)	Health: 28
A	TY	(6)	
S	TY	(6)	Karma: 26
E	GD	(10)	
R	GD	(10)	Resources: PR(4)
I	TY	(6)	
P	GD	(10)	Popularity: 6

**WEAKNESSES:** Sharon is extremely allergic to milk and other dairy products. Ingestion of such products makes Sharon feel ill and requires a successful green Endurance FEAT to avoid incapacitating cramps for 1 -10 hours.

**CONTACTS:** Sharon knows the FF through Johnny, whom she dated a few times.

**BACKGROUND:** Sharon is a working woman

trying to find fortune and happiness in NYC. Currently she is working at TV City, a television studio. Like most people, she couldn't afford an apartment on her own and so went looking in the want ads. She found a place rooming with Julie Angel. Although she thought Julie's story that her previous roommate had left Earth with Galactus was a little weird, she realized it was the truth when she met Julie's then-boyfriend, Johnny. Sharon fell for Johnny at once. Sharon and Johnny didn't get to know each other until Sharon stumbled across the Pseudo-Skrull colony in King's Crossing, NY. They dated a bit after Julie left for Hollywood, but nothing ever came of it. She and Johnny remain friends.

**RUNNING SHARON:** She is an independent woman who doesn't concern herself with public attitudes or opinions. This carries over to her personal appearance, and reflects her casual nature. Her allergy to dairy products enabled her to uncover the "Skrull invasion" of King's Crossing, NY.

## TARIANNA

F	IN	(40)	Health: 120
A	EX	(20)	
S	RM	(30)	Karma: 50
E	RM	(30)	
R	GD	(10)	Resources: PR(4)
I	GD	(10)	
P	RM	(30)	Popularity: 20

**KNOWN POWERS:** None.

**TALENTS:** Tarianna was a superb warrior, possessing the talents of Martial Arts A, B, and E, as well as Acrobatics.

**CONTACTS:** Tarianna was the Thing's female alter ego.

**BACKGROUND:** During his sojourn on the Battle-planet following the Secret Wars, the Thing befriended the swordswoman Tarianna. They journeyed across that world together and eventually fell in love. The relationship was doomed when Ben discovered that Tarianna was his own anima, or female alter ego, given life by the peculiar properties of the Battle-planet. During this time, the Thing had also generated a living copy of his human self. The Thing was about to be killed by the human Ben when Tarianna killed the human Ben. This death triggered Tarianna's own death and the final destruction of the Battle-World. Even though the Thing realizes Tarianna was a construction drawn from his own mind, he still mourns her loss. Shortly after his return to Earth, the Thing discovered Sharon Ventura, a lookalike for the lost Tarianna (see Ms. Marvel II).

**RUNNING TARIANNA:** Tarianna is a valiant fighter and the Thing's devoted companion.

## PHINEAS HORTON

aka Thomas Raye

F	TY	(6)	Health: 32
A	TY	(6)	
S	GD	(10)	Karma: 54
E	GD	(10)	
R	IN	(40)	Resources: EX (20)
I	GD	(10)	
P	PR	(4)	Popularity: 5

**TALENTS:** Professor Horton is a brilliant scientist working in the fields of Genetics and Biochemistry. He is also trained in Hypnosis.

**CONTACTS:** He is the creator of the original Human Torch and the stepfather of Frankie Raye.

**BACKGROUND:** Prof. Horton was a biotechnology pioneer in the late 1930s. His crowning achievement was the creation of the first android, the original Human Torch. Unfortunately, Horton had not foreseen his creation's incendiary powers. Horton was believed killed in the resulting fire. In later years, he changed his name to Thomas Raye, became a repairman, and married a woman with a daughter, Frankie, from a previous marriage. Frankie was 14 when "Thomas" read about the new group, the FF. He flew into a rage and took his daughter to a long abandoned chemical warehouse in NYC. His intention had been to revive or recreate the original Human Torch. However, an accident resulted in Frankie receiving the Torch's powers.

Distraught by what he had done, "Thomas" hypnotized Frankie into forgetting her powers and her life up till then.

He left Frankie but he sent her enough money each month that she could survive. Years later the money stopped when Horton was killed in a battle with supervillains.

**RUNNING DR. HORTON:** Horton was a driven man. He was obsessed with gaining the glory he felt he deserved as the creator of the first android. He was also obsessed with his creation, the original Human Torch.

## IMPOSSIBLE MAN

F	RM	(30)	Health: 170
A	RM	(30)	
S	GD	(10)	Karma: 42
E	UN	(100)	
R	TY	(6)	Resources: N/A
I	TY	(6)	
P	RM	(30)	Popularity: 3



**KNOWN POWERS:**

*Shapeshifting:* The Impossible Man has the Shift-Z ability to transform himself into anything he dang well wants. His only limitation is that he cannot change color; whatever he turns into must be green and purple. Impy has developed his power into Stunts that simulate other powers.

- **Lifeform Creation**—Impy is able to asexually reproduce by dissolving his body into a green and purple cloud, then re-coalescing into two or more distinct beings.
- **True Invulnerability**—Due to his malleable structure, Impy has Unearthly resistance to physical damage. He is subject to Slam results but cannot be Stunned.
- **Power Duplication**—Impy can duplicate the powers of anything he is mimicking (dragon's flame, Thor's hammer, stardrive, etc.). Such mimicked Powers are of Good rank if he is using his own power and Amazing rank if he is being stimulated by his ship.
- **Self Sustenance**—Impy does not need to consume air, food, or whatever for extended periods of time, such as when he is in deep space.
- **True Flight**—Impy can travel independently through space at CL3000 speed.

*Mass Mind:* Impy has absorbed the minds of all the Poppupian race.

**TALENTS:** Impy must be an expert on Astro-Navigation, otherwise he wouldn't have been able to find Earth so many times.

**CONTACTS:** The FF are on uneasy terms with Impy but he did offer his planet to Galactus in place of Counter-Earth, so they probably owe him one. Lately, Impy discovered the shapeshifting Warlock and through him has be-

come friends with the New Mutants.

**BACKGROUND:** Impy is a native of Poppup, a world dominated by fierce and dangerous monsters. To survive, the local humanoids developed the power of Shapeshifting to protect their bodies and a mass mind to protect their individual minds in case the Shapeshifting didn't work. Unlike the universe's other shapeshifting race, the Skrulls, the Poppupians used their powers to have fun.

Impy was born with a genetic flaw that gave him a free will and independent decision-making capabilities. He decided he was bored with Poppup and left for deep space. Eventually he discovered (in order) the Earth, television, and the FF. He wanted to be entertained and couldn't understand why the Earth people resented his attempts to enliven the scene. Reed convinced the entire east coast of the U.S. to simply ignore Impy, no matter what he did. Impy swiftly got bored and left Earth for deep space.

**RUNNING THE IMPOSSIBLE MAN:** Impy is a bored, hyper-active, mischievous kid. He is a wide-eyed innocent who really doesn't understand the harm he is capable of doing. Fortunately, he is at heart a benevolent soul who would never harm anyone intentionally. One final note: he cries A LOT if he can't get his way.

**STINGRAY**

**Dr. Walter Newell**

F	GD	(10)	Health:	130
A	RE	(30)		
S	AM	(50)	Karma:	40
E	IN	(40)		
R	EX	(20)	Resources:	RM(30)
I	GD	(10)		
P	GD	(10)	Popularity:	20

**KNOWN POWERS:**

*Exoskeleton:* What powers Dr. Newell has are derived from his use of the Stingray armor. Without the armor his ranks are:

F	A	S	E	R	I	P
GD	GD	TY	GD	EX	GD	GD

*Body Armor:* The Stingray armor gives Newell Remarkable protection from physical attacks (including pressure from the ocean's depths), Excellent protection from energy attacks, and Amazing protection from heat, cold, and electricity.

*Self Sustenance:* Artificial gills within the armor provide him with unlimited oxygen. Note that the system cannot provide him with oxygen where none is present, such as outer space.

*Hyper-Swimming:* Propulsion systems give him Good waterspeed.

*Gliding:* After launching himself from the water, Stingray can attain Poor airspeed (60 mph) and a maximum altitude of 100 feet.

*Electrical Generation:* Stingray can release a

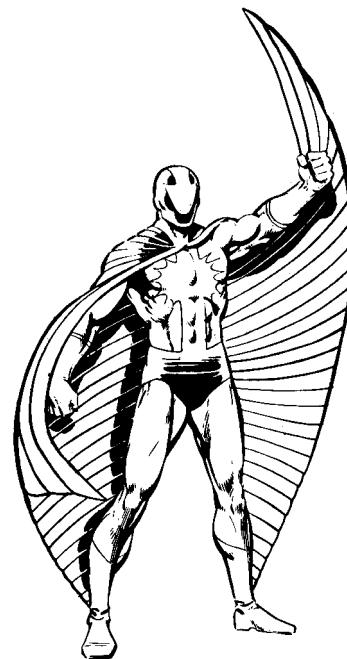

blast of Incredible Intensity electricity at a range of up to 1 area. Targets of the blast must make an Endurance FEAT or fall unconscious for 1-10 rounds.

**TALENTS:** Dr. Newell is a master of several disciplines related to the oceans. He is an oceanographer, ocean archeologist, ichthyologist, and cetologist. He has made a special study of methods for adapting surface humans to an aquatic existence.

**CONTACTS:** Dr. Newell has been employed by the Navy and FBI. He is a friend of Namor and the Thing and positively adored by Dr. Henry Croft and the other people he helped restore to normal.

**BACKGROUND:** Dr. Newell was an oceanographer employed by the government when he oversaw construction of an experimental domed undersea city (later destroyed by the Plunderer). Newell befriended Namor during this period. Later he was ordered to capture Namor, who had been accused of some crime. To enable himself to do this, Newell constructed the Stingray armor. After clearing Namor's name, Newell resumed his research. He met the FF when he was helping a group of people regain their humanity after Dr. Hydro had transformed them into amphibians resembling Triton of the Inhumans.

**RUNNING STINGRAY:** Dr. Newell's life is devoted to exploring the ocean's secrets. The Stingray armor helps him out immeasurably. He is driven to correct any injustice or fight any calamity that is related to the ocean. The thrill of adventuring as Stingray is gradually winning over the urge for scholarly research.

## CRUSADER

Robert Grayson a.k.a. **Marvel Boy**

F	IN	(40)	Health: 120
A	GD	(10)	
S	IN	(40)	Karma: 18
E	RM	(30)	
R	TY	(6)	Resources: PR(4)
I	TY	(6)	
P	TY	(6)	Popularity: 0

### KNOWN POWERS:

**Power Source (Wristbands):** All of Grayson's powers are derived from his special wristbands. The bands absorb solar radiation and transform it into powers and enhanced Abilities for the wearer. If Grayson loses the bands all his Abilities drop to Typical rank.

**Gravity Manipulation:** The bands can lessen the gravity of heavier planets to that of Earth. In areas of lighter gravity, the power can be developed to enable him to fly at Typical speed.

**Light Control:** The bands have the Excellent ability to magnify low light levels to a point where normal daylight vision is possible. In daylight, the bands can create blinding bursts of light. (Anyone within two areas of the bands when they use this power must make an Intuition FEAT against Amazing Intensity or suffer 1-5 rounds of blindness.)

**Light Emission:** The bands can emit any frequency of light with Excellent intensity.

**Gateway:** The bands can create warps into the "Quantum Zone," a realm of unknown subatomic particles. These particles can form into a blast that does Amazing damage.

**True Invulnerability:** The bands give the wearer Monstrous resistance to physical and heat attacks.

**TALENTS:** Grayson was trained in branches of the Uranian sciences that are unknown on Earth.

**CONTACTS:** None.

**BACKGROUND:** Grayson is the son of Dr. Horace Grayson, a German Jew who fled Germany before WWII. Fearing the war he knew was about to erupt, he designed a rocketship that would carry him and his infant son safely away from Earth. He made radio contact with the Uranians, a colony of the Eternals who had left Earth millennia before. The Uranians gave Dr. Grayson the help he needed to leave Earth for their world.

Robert Grayson grew up in the small dome that housed the colony. He was given the training of a young Eternal and taught to use the powers supplied him by the bands. When he was 17, he convinced his father to let him return to Earth and to fight evil. During the 50s he became a popular crimefighter known as **Marvel Boy**. After three years, he was recalled to Uranus to care for his ailing father. He



Quasar by Art Adams  
Courtesy of www.quantumzone.org

returned again to Earth to acquire the supplies he needed. Tragically, when he finally returned, he discovered the Uranian dome shattered and everyone dead. He vowed to avenge his father and the Uranians by destroying the New York bank which had hindered his efforts to return to Uranus.

En route again to Earth, his ship was caught in the tail of a mysterious comet. Grayson was placed into suspended animation. His voyage was extended from days to decades. When he finally returned to Earth, he was an adult, and insane. He nearly killed the banker who had caused him so much trouble and destroyed some branches of the Grover Cleveland Bank. When the FF attempted to halt the rampage he tried to increase the power given him by the bands. The power level was too high; Grayson was disintegrated in a burst of light.

The bands survived and Reed gave them to SHIELD. They were in turn given to Dr. Gilbert Vaughn for study, who then gave them to his son to use as the super-hero Quasar.

**RUNNING CRUSADER:** In the 1950s, **Marvel Boy** was a bright, friendly teen who was out to stop all crime and bring about world peace. If the adventure is set later in Robert's career; Crusader was a rampaging psychotic who would stop at nothing to destroy the Grover Cleveland Bank.

## QUASAR

Wendell Vaughn

F	EX	(20)	Health: 50
A	GD	(10)	
S	GD	(10)	Karma: 22
E	GD	(10)	
R	GD	(10)	Resources: GD(10)
I	TY	(6)	
P	TY	(6)	Popularity: 10

### KNOWN POWERS:

**Power Source (Wristbands):** All of Quasar's powers are derived from the Uranian wristbands formerly used by the late Crusader. The bands tap available solar energy and convert it into powers Quasar can use.

**Energy Solidification:** The bands can emit objects of "solid" light. The objects are shaped by Quasar's imagination and can be used to create a variety of useful shapes, such as weapons, shields, cages, and aerodynamic designs. The objects have Monstrous Material strength and do Monstrous damage if used as weapons. If the force is used as shields, Quasar can block up to three separate attacks at Monstrous power level and will automatically win initiative against any such attacker the next round.

**Light Generation:** The bands can create Monstrous bursts of light.

**True Flight:** Quasar can fly at Shift-Y speed (Mach 2) in the atmosphere, and presumably even faster in interplanetary space.

**TALENTS:** Vaughn is a veteran of the U.S. army and a SHIELD trainee. He possesses Law Enforcement and Espionage skills. He is trained in Martial Arts A and B, as well as handgun use.

**CONTACTS:** Vaughn has contacts with SHIELD, Project Pegasus, Bill Foster, and the FF through his buddy the Thing.

**BACKGROUND:** Wendell Vaughn was a SHIELD trainee when his father acquired the Uranian wristbands used by the late Crusader. Wendell was supposed to use the bands so his father could study their effects. Unfortunately, the bands grafted themselves onto his wrists. Wendell then volunteered for SHIELD's "Super-agent" program, where he was code-named **Marvel Man**. When the program was discontinued, he changed his name to Quasar and got the job of security chief for Project Pegasus. There he met Ben. He served during the Project's most violent period. After the Serpent Crown temporarily took control of his mind, Quasar felt so disgraced that he resigned and disappeared without revealing his plans. Rumors suggest he is now making his way to Uranus.

**RUNNING QUASAR:** Quasar is aware that, while he has the potential for great powers, his control over them is not that fine. He's still a bit insecure about his role as a superhero, although he hides it well.



## GUARDSMAN

Michael O'Brien

F	EX	(20)	Health: 90
A	EX	(20)	
S	IN	(40)	Karma: 30
E	AM	(50)	
R	GD	(10)	Resources: GD(10)
I	GD	(10)	
P	GD	(10)	Popularity: 20

### KNOWN POWERS:

*Exoskeleton:* O'Brien receives his powers from the use of the Guardsman armor. Without the suit, his physical Abilities are:

F	A	S	E
GD	GD	TY	GD

*Body Armor:* The Guardsman armor gives him Incredible protection from physical attacks, Excellent protection from most energy attacks, and Monstrous protection from radiation.

*Rocket:* Internal systems give him Remarkable airspeed (250 mph) and a maximum flying time of two hours.

*Fire Generation (feet):* His rocket boots enable him to do Excellent damage to any target within 2 areas.

*Plasma Generation (Repulsors):* Gauntlet mounted Repulsor projectors emit blasts that can do Incredible damage at a range of up to 5 areas.

*Self Sustenance:* The armor contains an internal air supply sufficient for 30 minutes' use.

**TALENTS:** Michael O'Brien is a policeman and has the Law Enforcement talent, as well as Martial Arts E.

**CONTACTS:** Michael was originally a sergeant in the NYPD. Later he replaced Quasar as Security chief for Project Pegasus. He is an acquaintance of the Thing.

**BACKGROUND:** The Guardsman armor was designed by Tony Stark to serve as an emergency backup system. He gave it to a friend and employee, Kevin O'Brien. Unfortunately, an emergency caused O'Brien to don the armor before a fatal flaw was detected; mental feedback affected the Guardsman's mind and drove O'Brien into a jealous rage directed at Iron Man. In the ensuing battle, O'Brien was killed.

Months later, Michael O'Brien acquired the armor while investigating his brother's death. The flaw induced Michael to baffle Iron Man as well. Afterwards, Stark fixed the error and gave the suit to Michael.

Michael eventually quit the NYPD and replaced Quasar as head of Project Pegasus security. When his armor was damaged during a battle with the Lava Men (see Subterraneans), the suit was rebuilt and duplicated by Stane Industries. Michael was later transferred to be security chief for the Vault, where all the staff now wear copies of the Guardsman armor.

**RUNNING GUARDSMAN:** Michael O'Brien is a diligent policeman who believes in honorably fulfilling his duties.



## THUNDRA

F	AM	(50)	Health: 140
A	EX	(20)	
S	AM	(50)	Karma: 22
E	EX	(20)	
R	TY	(6)	Resources: EX(20)
I	GD	(10)	
P	TY	(6)	Popularity: 8(76)

### KNOWN POWERS:

*True Invulnerability:* Thundra has Typical resistance to physical, attacks.

*Hyper-Leaping:* Thundra can make Remarkable leaps (45 ft. up or across, 60 ft. down).

*Hyper-running:* Thundra can run at Typical groundspeed (45 mph).

**TALENTS:** Thundra has the Weapons Master talent, and is also proficient in all Fighting Skills. She is a skilled Military and Political leader, as befits her station as head of the U.S.R.

**CONTACTS:** Thundra is a long-time associate of the FF. She is leader of the U.S.R. in her home time period.

**BACKGROUND:** Thundra is a citizen of the United Sisterhood Republic, a country in an

alternate 23rd century Earth, Fernizonia. Thundra was born in a government-run birth lab, where she was genetically engineered for greater strength, endurance, and resistance. She began to study military skills at age 8; by the time she was 18, she was the U.S.R.'s finest warrior. When her world was invaded by soldiers from another alternate timeline, Macchus, Thundra acted to prevent Macchus from ever existing. She stole the Macchians' time machine and traveled to 20th century Earth. Her plan required her to defeat Earth's finest warrior, the Thing. When the Wizard learned of her intentions, he recruited her for the Frightful Four. From there she fought the Thing on several occasions and even beat him once. However, she eventually realized that her actions would not affect the creation of Macchus. She turned against the Frightful Four. Afterwards, she became friends with the FF and began to develop a liking for Ben. Thundra was instrumental in merging the alternate timelines of Fernizonia and Macchus. For a time, she stayed in the 20th century because he felt her world no longer existed. She wandered around and got further involved in Ben's life. She aided him in stopping Roxxon Oil's attempt to plunder the resources of other dimensions. She used the Nth Projector to return to her world and time. There she became Empress of the renamed United Sisterhood Empire. Her people wanted her to establish a dynasty. She decided that, since Ben was the only male she respected, he should marry her. When an emergency prompted her to call Ben to her time, she took the opportunity to propose. Because acceptance meant Ben would be forever unable to return to his time, he declined. As a favor, Thundra first returned Ben to an alternate timeline where he could propose to Alicia (Ben left her at the altar), then finally returned him to his own timeline. Since that time, Thundra has remained in her world, leading the expansion of the U.S.E.

**RUNNING THUNDRA:** Thundra is an aggressive fighter with a near-total disdain for men. She is a brilliant tactician and an honor-bound fighter. She is also prone to fits of rash behavior and may act before the time is right. She has a soft spot for Ben, but her personality won't let her admit it's something more than simple respect.



## AQUARIAN Wundarr

F	PR	(4)	Health: 94
A	GD	(10)	
S	RM	(30)	Karma: 76
E	AM	(50)	
R	TY	(6)	Resources: PR(4)
I	IN	(40)	
P	RM	(30)	Popularity: 10

### KNOWN POWERS:

*Enhanced Attributes:* The statistics for the Aquarian consider only his career after being affected by the Cosmic Cube. Previous to this, his abilities were:

F	A	S	E	R	I	P
EX	GD	AM	AM	FB	TY	PR

*Hyper-Leaping:* Wundarr could attain Class 5000 leaps (2 miles straight up, 3 miles horizontally).

*Body Resistance:* As Wundarr, he had Uearthly resistance to brute force attacks. The intended damage from such attacks was converted into energy for Wundarr's use, so that he accumulated a reservoir of power equal to one fourth the force used against him. For example, an Amazing intensity attack would not only leave Wundarr unharmed, but would also give his reservoir 12 points. Every round of inactivity also added one point of stored energy. Every time he used his Strength or his Leaping ability, Wundarr expended 20 points. If he let it build, he could release the stored

energy in a Force Blast of Intensity equal to the number of stored points. After 100 points, such a release (at Uearthly intensity) was involuntary.

*Force Field v. Energy:* As the Aquarian, he has the Uearthly ability to project a spherical field that dampens certain energy forms, applying -10CS to any effects. Such forms include electricity, gravity, light, magnetism, radiation, and sonics. The field can have a radius from 5 inches to 10 areas. He can alter the effect, size, and intensity of the field at will but he can never completely shut it down. This field prevents his Hyper-Leaping power from functioning. However, it can be used to create a variety of new Power Stunts, such as:

- Skywalking—Aquarian can travel at Good landspeed even when he is walking through the air.

*Animal Empathy:* Aquarian possesses the ability to understand animals at Poor rank. It is against his ethics to use this power to control any creature.

**TALENTS:** The Aquarian has First Aid skill.

**CONTACTS:** Wundarr was originally Ben Grimm's ward and a patient at Project Pegasus. He was also "adopted" by Namorita. As the Aquarian, he assisted the Cosmic Cube to attain its next state of being; perhaps that being will return the favor someday.

**BACKGROUND:** Wundarr is a native of the planet Dakkam. As an infant, he was shot into space after his father incorrectly predicted Dakkam's imminent explosion. Wundarr spent the voyage in partially-suspended animation; he physically matured but his mind remained arrested in infancy. Cosmic energy endowed the sleeper with his original powers.

When Wundarr arrived on Earth, he crashed into a Florida swamp where he was released by the Man-Thing. He was given briefly into the custody of the Thing, Namorita, and finally Project Pegasus. Following experiments that used him to probe the Cosmic Cube, he attained a psionic link with the being within. The communion eventually transformed him into the Aquarian and gave him a sense of purpose at last. He has since used his powers to help the Cosmic Cube pass on to its next level of existence.

**RUNNING AQUARIAN:** As Wundarr, he is an infant in an adult body. As the Aquarian, he is a would-be messiah out to lead humanity into a higher consciousness.

## WATCHER

### Uatu

F	AM	(50)	Health: 250
A	AM	(50)	
S	AM	(50)	Karma: 300
E	UN	(100)	
R	UN	(100)	Resources: UN(100)
I	UN	(100)	
P	UN	(100)	Popularity: 0

### KNOWN POWERS:

*Clairaudience:* He has Uearthly range (2.5 billion miles).

*Clairvoyance:* Uearthly range.

*Communicate With Animals:* Uearthly ability to speak with animals.

*Communicate with Cybernetics:* Uearthly ability to speak with intelligent machines or to take readings from non-self-aware devices.

*Communicate with Plants:* Uearthly ability to speak with the higher forms of plant life.

*Cosmic Awareness:* C1000 awareness of this universe and several others that exist as alternates of this one.

*Empathy:* Uearthly ability to read emotions.

*Force Field Generation:* a protective field of C1000 rank.

*Force Field v. Psionics:* a protective field of C1000 rank that can be extended to include anyone he chooses.

*Gateway:* He has a C5000 range that can reach distances up to 500 light years at a jump.

*Immortality:* Uatu may be several million years old.

*Kinetic Bolt:* Uatu can fire bolts of Uearthly Intensity.

*Linguistics:* Uatu has C1000 ability to understand any language.

*Mental Invisibility:* He has the C1000 ability to render himself and anyone he chooses undetectable by psionic means.

*Mind Probe:* Uearthly rank probes of minds and psionic phenomena. Curiously, his use of this or Telepathy gives his target Uearthly protection against any other entity's attempt to do likewise.

*Remote Sensing:* Uearthly ability to extend the range of his senses (excluding those as above).

*Self-Sustenance:* Uatu has never been known to eat, drink, or be required to breathe. However, all members of his race must occasionally bathe in particular radiations.

*Shapeshifting:* To aid their covert surveillance of the universe, all Watchers have the Uearthly ability to transform themselves to mimic whatever lifeform they are observing.

*Telekinesis:* He has Uearthly abilities, mostly used to operate machinery and fetch items.

*Telelocation:* He has the C5000 ability to locate anyone in the universe.

*Telepathy:* C5000 communication with other Watchers and Entities. Otherwise Uatu decreases his rank to Uearthly when dealing with mortals.



*Teleportation:* C5000 range (500 light years).  
*Total Memory:* Uatu has C5000 recall of everything he has ever experienced.  
*Levitation:* Uatu has Uearthly rank.  
*True Invulnerability:* Uatu has C1 000 resistance to all attacks.

**TALENTS:** You name it, he can probably do it or can refer to something that tells him how to do it.

**CONTACTS:** Because Watchers typically never help anyone, no one ever helps them. However, Uatu's peculiar behavior has given him Contacts with the FF, his neighbors the Inhumans, Asgard, and Galactus.

**BACKGROUND:** The Watchers are one of the first races to evolve in our Universe. Originally the Watchers decided to assist the races around them to attain high levels of technology and (they hoped) civilization. Unfortunately, their good intentions were lost on some of their charges. One race to whom they gave nuclear technology created genocidal weapons, destroying two civilizations. Shocked by the results of their interference, the Watchers decided that they would only observe the universe and never again interfere. They hold to this pledge even when they are aware that incredible disaster results from their inactivity. For example, a Watcher had the chance to destroy a still-forming Galactus. Adult Watchers are assigned a star system to monitor for

developing life.

Uatu is considered the Watcher's equivalent of a juvenile delinquent. Uatu developed a fascination for the boisterous human race and has decided to aid its development. Rather than overt help, though, he tends to warn humans of impending danger or to indirectly suggest solutions to their problems. He will ignore direct appeals for help.

**RUNNING THE WATCHER:** Uatu has a special fondness for humans, especially the FF. While he will never directly aid them, he will suggest where they might find solutions among his possessions or powers. Occasionally he will add himself to a party as "an observer." Although he will not directly participate in the adventure, his Karma is added to the group's Karma Pool.

## HIGH EVOLUTIONARY

Herbert Edgar Wyndham

F	RM	(30)	Health: 3080
A	RM	(30)	
S	EX	(20)	Karma: 5000
E	C3000		
R	C1000		Resources: C1000
I	C1000		
P	C3000		Popularity: 0 (100 from his creations)

### KNOWN POWERS:

*Cyborg Exoskeleton:* The High Evolutionary is almost always in his armor, which contains internal computers that supply him with most of his powers and Abilities. Note that the suit will always return to Wyndham in 1-100 weeks if he is separated from it. He cannot voluntarily remove more than his helmet.

*Body Armor:* His suit provides Uearthly protection against physical attack and Shift-Z protection against energy, psionic, and magical attacks.

*Clairaudience:* C1000 range.

*Clairvoyance:* C1000 range.

*Communicate with Animals:* C1000 ability.

*Communicate with Cybernetics:* His suit gives the High Evolutionary this power at C1000 rank.

*Cosmic Awareness:* C1000 rank.

*Danger Sense:* At C1000 rank, he is also aware of danger threatening his creations.

*Induced Evolution:* With his exoskeleton's equipment, he can transform a animal into an evolved demihuman.

*Free Spirit:* Wyndham can leave his body for extended periods and roam the cosmos. If his body is destroyed, Wyndham's armor can sustain his lifeforce indefinitely.

*Growth (Atomic Growth):* He can enlarge the size of his own atoms so that he may become as large as Galactus. His basic stats do not change while he is in this state.

*Levitation:* C1000 rank.

*Linguistics:* C1000 rank.



*Mental Invisibility:* At C1000 rank, this power also extends to his creations if they are within range.

*Mental Probe:* C1000 rank.

*Mind Blast:* Another power from his suit, with C1000 rank.

*Matter Creation:* With his armor, the High Evolutionary has six forms of this Power, each with C1000 rank:

- **Artifact Creation**—He can instantly create complex shapes.
- **Elemental Creation**—He can create any element he needs.
- **Lifeform Creation**—He can create permanent, living beings of any type.
- **Mechanical Creation**—He can create complex mechanical devices.
- **Missile Creation**—He can use his creations to do up to Uearthly damage.
- **Spray Creation**—He can create sudden torrents that do up to Uearthly damage.

*Reality Alteration (Future):* The Suit automatically expends up to 150 Karma to prevent anything catastrophic from happening to the High Evolutionary.

*Regeneration:* The armor contains a complete record of Wyndham's body, personality, memories, and powers. If his body is destroyed but the suit remains functional, it can eventually recreate Wyndham and return him to life.

*Self-Sustenance:* The suit automatically recycles bodily wastes, thus freeing him from the need to breathe and so on.

*Speechthrowing:* He can make himself heard



at C1000 range.  
*Telepathy:* C1000 rank.  
*Total Memory:* C1000 rank.

**TALENTS:** Wyndham was originally a leading expert on Genetics and Engineering. These abilities, and a host of new skills, were raised to provide +3CS to any Reason FEAT when he was transformed into the High Evolutionary.

**CONTACTS:** The High Evolutionary has had a host of Contacts, including the Avengers, the FF, the Knights of Wundagore, the populace of Counter-Earth (now destroyed), and Adam Warlock (no longer on this plane of existence).

**BACKGROUND:** Wyndham was a pioneer of genetics at Oxford when he created his first evolutionary accelerator. Hostility from the scientific community prompted Wyndham and his partner Jonathan Drew to build a lab on Wundagore Mountain in Transia. When uranium was discovered under Wundagore, Wyndham gained a fortune that enabled him to create his scientific citadel and achieve greatness. Wyndham used his evolutionary accelerator on himself and gained his present abilities. When he realized that the Transia countryside was a focal point for much of the magic in Europe and that such forces could threaten him, he created his suit of armor. He then created the Knights of Wundagore, demi-human "New Men" astride robotic mounts, to defend him against the demon Chthon who dwelled in the earth below. When he decided to leave Earth, he transformed his citadel into a starship. His "New Men" colonized a world orbiting Sirius It. The new world of Wundagore

is a curious blend of medieval knighthood and high technology.

Next, he created a full-scale copy of the Earth. Counter-Earth was located on the far side of Earth's orbit. It was populated by the "New Men," animals who had been accelerated to resemble human. Many of the New Men were patterned after existing Earth humans, such as Reed Richards and Doctor Doom. In a strange twist, the President was a werewolf-like berserker.

Counter-Earth was stolen by a group of beings called Beyonders. At first Wyndham rushed to rescue his planet, but when he learned the Beyonders were interested in his work, he felt flattered. He encountered a traumatic shock when Counter-Earth was dismissed as "local talent." His ego crushed by a sudden rush of inferiority, Wyndham went quietly mad and tried to commit suicide. Fortunately, his suit wouldn't let him succeed. He tried to get the Hulk to demolish his suit. While the Hulk damaged enough of the suit that Wyndham was able to devolve into a mass of one-celled organisms, the suit retained its self-repair ability. The suit is now quietly rebuilding itself; when it's done, the High Evolutionary will live again (whether he wants to or not).

**RUNNING THE HIGH EVOLUTIONARY:** The High Evolutionary is a firm believer in the obligations of noble, higher-powered beings to protect lesser beings. He sees himself as Galactus' natural enemy and yet he would not allow Galactus to die. Rather, he temporarily accelerated Galactus' evolution to the point where Galactus would no longer need to devour worlds.



## ADAM WARLOCK

Him

F	IN	(40)	Health: 160
A	IN	(40)	
S	RM	(30)	Karma: 60
E	AM	(50)	
R	GD	(10)	Resources: FB(2)
I	EX	(20)	
P	RM	(30)	Popularity: 10

### KNOWN POWERS:

**Absorption Power:** Warlock automatically absorbs available Cosmic energy and transforms it into useful powers and personal energy. Through a Power Stunt he could raise either his Strength or Endurance rank +2CS for 5 turns. He could do this a total of once per day.

**Armor Skin:** Warlock could generate a protective cocoon of Incredible Material strength.

**Flight:** Warlock could attain Shift-X velocity (770 mph airspeed; 80,000 mph in space).

**Dimension Travel:** Warlock could travel into other dimensions with Amazing ease. This includes the ability to travel instantly through hyperspace to distant points in space.

**Light Generation:** During Him's formative period, he possessed an uncontrollable power that destroyed mechanical recording devices and temporarily blinded living beings. This power vanished when Him left his cocoon.

**Healing:** When in the Cocoon, Warlock possesses Monstrous self-healing.

**Self Sustenance:** Warlock can survive indefinitely without air, water, or food.

**True Invulnerability:** Warlock possesses Good resistance to physical and energy attacks, including the rigors of deep space.

**SOUL GEM:** The Soul Gem is one of six magical gems scattered throughout the universe. Together the six could shatter the fabric of reality itself. The other five gems were dispersed when Thanos attempted to do just that. The Gem is intelligent and malevolent:

R I P  
 IN MN LIN

The Gem may substitute one of its attributes for that of Warlock. The gem possesses several powers which Warlock could use as if his own.

**Devolution:** This Amazing power can negate induced evolution and return the targeted being to its original state.

**Linguistics:** The Gem has the Monstrous ability to instantly translate any being's language.

**Kinetic Bolt:** Warlock could fire Incredible beams of pure force through the Soul Gem.

**Spirit Storage:** The Soul Gem has the Unearthly ability to forcibly remove a person's spirit and trap it within.

**Internal Limbo:** The Gem acts as a gateway to a pocket dimension populated by the spirits drawn into the Gem. This limbo appears to be a pleasant park where everyone enjoys tranquility.



He also began to evolve toward "godhood." He first acted as a messiah on Counter-Earth but was later executed by the authorities there. He returned to deep space. There he discovered that he was caught in a timeloop. One version of Warlock had become a totalitarian god named Magus. Warlock joined Thanos in battling and eventually destroying Magus. As he died Magus told Warlock he was supposed to be the champion of life and nemesis of Thanos, Death's champion. Later Warlock led the Avengers against Thanos. As a result of the timeloop, a younger Warlock appeared and absorbed Warlock's soul into the Soul Gem.

His body was later resurrected by Her, but she returned it to death when she realized his soul was elsewhere. At the present time, no one knows Warlock's spirit is a content resident of the internal limbo within the Soul Gem.

**RUNNING WARLOCK:** Warlock was concerned with finding a reason for his existence. While he was looking for It, he acted as the champion of all threatened beings. Whether the drive for godhood was a sidetrack or an inkling of his destiny has not yet been determined.



**Mental Duplication (Merger):** This Monstrous power gives the host of the soul gem a duplicate set of memories of each person drawn in by the Spirit Storage power.

**TALENTS:** Warlock initially possessed no talents at all. However, he gained the talents of everyone drawn into the Soul Gem. These skills include all Martial Arts, Weapons Master, Astro-navigation, and Piloting.

**CONTACTS:** As Him, Warlock was the tool of the Enclave; they are no longer enemies. Although the FF were originally Him's enemies, they later became allies. As Warlock, his friends included some of the Avengers, the High Evolutionary, and the people of Counter-Earth.

**BACKGROUND:** Him began as a living weapon created by the Enclave, a scientific-criminal organization. During his formative period, he emitted rays that disrupted recording equipment and prevented anyone from seeing Him without harm. The Enclave lured Alicia to their base to do a sculpture of Him (this was the only way of "seeing" Him at the time). When the FF came to rescue Alicia, the cocoon hatched. Him and the FF clashed until he realized that it was the Enclave who were the villains. Warlock destroyed the Enclave's headquarters as he fled into space.

Later Him went through a lengthy period of personal growth and physical transformation.

## HER Paragon

F	RM	(30)	Health: 210
A	RM	(30)	
S	MN	(75)	Karma: 50
E	MN	(75)	
R	GD	(10)	Resources: FB(2)
I	GD	(10)	
P	RM	(30)	Popularity: 0

### KNOWN POWERS:

**Absorption Power:** Her automatically absorbs available Cosmic energy and transforms it into useful powers and personal energy. By a Power Stunt she can raise either her Strength or Endurance rank + 2CS for 5 turns. She can do this once per day.

**Armor Skin:** Her can generate a protective cocoon of Incredible Material strength.

**Flight:** Her can attain Shift-Z velocity (7800 mph airspeed; 600,000 mph in space).

**Healing:** While in the Cocoon, Her possesses Monstrous self-healing.

**Kinetic Bolt:** Her can fire Incredible beams of pure force.

**Self Sustenance:** Her can survive indefinitely without air, water, or food.

**True Invulnerability:** Her possesses Good resistance to physical and energy attacks, including the rigors of deep space.

**TALENTS:** Her initially possessed no Talents at all. She has since gained medical and astro-navigational skills.

**CONTACTS:** As Paragon, Her was the tool of the Enclave; they are now enemies. Her later made friends with the Thing and Moondragon.

**BACKGROUND:** Her was the Enclave's second attempt to create a superbeing under their control. They modified the original design to create a theoretically more responsive being; they also intended to have Dr. Strange perform a delicate brain operation they hoped would remove their creature's ability to rebel. They were wrong. History repeated itself as Paragon destroyed the Enclave's citadel and fled into space, where it drifted within a protective cocoon. Although Paragon was designed as a neuter, it was capable of significantly altering its form. Contact with the Enclave's computers had informed Paragon of Him's existence (see Warlock). Paragon decided to reform itself as Him's perfect mate, Her. Her went in search of Him and learned that, as Adam Warlock, he had perished battling Thanos. With the help of the Thing and Moondragon, Her located Warlock's body. She managed to force new life into it; however, the newly risen body lacked Warlock's spirit and mind. She returned the body to its grave, then went off in search of a mate elsewhere in space. Recently she was seen heading back toward Earth.

**RUNNING HER:** Her is concerned with finding her ideal mate. She believes she is to be the mother to a new race of superbeings. After her disappointment at failing to resurrect Warlock, she has set her sights elsewhere. She will willingly assist other beings if she thinks they can help her in the quest.

# RACES AND ORGANIZATIONS

## THE CHOSEN

F	GD	(10)	Health: 50
A	GD	(10)	
S	GD	(10)	Karma: 30
E	EX	(20)	
R	GD	(10)	Resources:EX(20)
I	GD	(10)	
P	GD	(10)	Popularity: 0

### KNOWN POWERS:

None.

**TALENTS:** The Chosen are trained in the design, construction, and operation of high tech items.

**CONTACTS:** The Chosen can call on the FF for help.

**BACKGROUND:** The Chosen were originally a tribe of yetis living in the Himalayas. Several centuries ago, they came under the leadership of a Tibetan monk known only as the Master who decided his mission was to lead them to enlightenment. Under his guidance, the Chosen flourished and quickly developed a technical culture that surpassed that of the outside world. As a sideline of their research, they discovered a treatment that greatly extended the Master's lifespan. However, as the Master grew older he maintained less direct control over the Chosen. In time, renegade elements seized control of the Chosen. They were preparing to conquer the world when the FF discovered the Chosen's existence. The FF aided the Master in transforming the Chosen from yetis to humans. With the transformation the Chosen lost their urge to conquer. The Master and his Chosen then retired to their hidden city.

**RUNNING THE CHOSEN:** When they were still yetis, some of the Chosen saw humans as inferior animals to be conquered or destroyed. The rest of the Chosen remained serene seekers of tranquility and enlightenment. The Master sees his purpose as leading at least a small part of humanity, the yetis, into spiritual enlightenment and better domestic conditions.

## QUON

F	EX	(20)	Health: 70
A	EX	(20)	
S	EX	(20)	Karma: 30
E	GD	(10)	
R	EX	(20)	Resources: FE(2)
I	PR	(4)	
P	TY	(6)	Popularity: 0

### KNOWN POWERS:

*Water Freedom:* The Quon are an aquatic race.

*Water-Breathing:* The Quon are amphibious.

*Hyper-Swimming:* Quon can attain Poor



speeds (30 mph).

*Communicate With Animals (Sea Life):* The Quon have the Excellent ability to command the higher forms of sea life.

**TALENTS:** The Quon male encountered by the FF was skilled in Astro-Navigation, Starship Piloting, and Biochemistry.

**CONTACTS:** The Quon male was befriended by the FF.

**BACKGROUND:** The Quon race is native to Quon, third planet from Byjak, a star in our galaxy. They are extremely strong, amphibious humanoids who have developed a star-traveling culture. A pair of Quons crashed in Lost Lagoon, coincidentally a spot where the FF were vacationing. The male went in search of materials to repair his ship and medical help for his mate. Through a series of misunderstandings he and the FF fought until Reed finally realized what the Quon was actually up to. After waving the FF away, the Quons took their ship into deeper water to continue repairs. Several months later, when the female became ill, the male invaded East Side Medical Pavilion in search of drugs. Coincidentally (again), the FF were present. The Quon kidnapped Sue because he needed someone who could administer the drugs he'd taken. After another battle, everything was cleared up. With his ship repaired and his mate well again, the Quon took his ship into space.

**RUNNING QUON:** The Quon do not speak or make any recognizable attempt at communication aside from the most basic gestures. The Quon male is devoted to his mate and, when things go awry, he tends to act recklessly. Because of his appearance and the lack of communication, he tends to be mistaken for a rampaging monster.



## SPINNERETTE Solon Stabilizer

F	TY	(6)	Health: 42
A	TY	(6)	
S	EX	(20)	Karma: 22
E	GD	(10)	
R	GD	(10)	Resources: none
I	GD	(10)	
P	FE	(2)	Popularity: 5

### KNOWN POWERS:

*Biophysical Control (Control Vertigo):* In a weightless environment, she can prevent the natural feelings of vertigo caused by the absence of gravity disturbing the delicate sense of balance. Unfortunately, in a natural gravity field, the power reverses itself, with the result that she has the Amazing ability to induce vertigo. Her power does rank level damage to a victim's Endurance. When the Endurance drops to zero, the person falls unconscious. The damage is not permanent and is quickly recovered once the victim regains consciousness.

**TALENTS:** She is skilled in basic Solonian medicine.

**CONTACTS:** Spinnerette has contacts with the FF and her home ship.

**BACKGROUND:** Spinnerette is one of a race of psionic clones, the Solons. All of her shipmates bear the group name of Solon, followed by their ship task (Solon Stabilizer, Solon Pilot, etc.). When her ship was forced to crash in Long Island Sound, Stabilizer volunteered to purchase the Indium they needed for repairs. Unfortunately, she became intoxicated in the oxygen-rich air, then fell in with a band of hoboes. In her confused state, she mistook silver for indium and began to loot jewelry stores. She did try to pay in Solonian coins, though no one recognized them as such. When Sue threw an air-tight field around Stabilizer's head, Spinnerette finally regained her composure. Reed gave her the needed Indium and she left with her ship.

**RUNNING SOLON:** Stabilizer is ordinarily a shy person but she's a mean drunk.



## INHUMANS

The Inhumans are the descendants of the results of a long-ago Kree experiment. 25,000 years ago, the Kree attempted to create a breed of superhuman earthling warriors to fight in the Kree's wars. Their scientists succeeded in creating a small tribe of superhumans but then abandoned the experiment. The tribe wandered Europe and Asia before they settled on a small Atlantic island, Attilan. During the millennia that followed, the tribe developed advanced technology and culture. They encountered the young Atlantean Empire but maintained their independence.

The Inhuman culture was devoted to scientific exploration, especially in the field of genetics. They set up a genocracy, a government controlled by the genetically fittest. Early in the Inhumans' history, they discovered the Terrigen Mists, a substance that interacts with human DNA to create superhuman mutations. The first user of the Terrigen Mists was its discoverer, Randac, who developed psionic powers. He instituted the program whereby all Inhumans could be exposed to the Mists. Unfortunately, half of the test subjects developed non-human appearances and the program was halted. The induced mutations passed into Attilan's gene pool. In the centuries that passed, discrimination against non-human Attilaneans was so pronounced that it prompted a revolt. The revolt's leader, Gal, forced everyone to be exposed to the Terrigen Mists. 75% of Attilaneans developed non-human appearances. Successive exposure to the Mists by their descendants only widened the genetic diversity of the Attilaneans. The culture stagnated as people were divided by appearance into "Mutation Camps." This program was discontinued when Gal was deposed by Auran. It was Auran who taught the people to celebrate their diversity and renamed the Attilaneans the Inhuman Race.

Attilan's geneticists created vigorous breeding programs designed to re-stabilize their race. Today, less than half of the Inhumans have a non-human appearance. The Inhumans also developed a cloned race of menial laborers, the Alpha Primitives.

The government of Attilan is divided into two arms. The Genetic Council's twelve members represent the legislative and judicial branches. The Council elects one of its members to be "king" of the Inhumans. He forms the Royal Family, which serves as the executive branch. 110 years ago, the scientist Agon was elected king. He was an extremely popular leader and possessed a brilliant understanding of Terrigen's effects on Inhuman genetics. He convinced his wife, Rynda, to undergo exposure while she was pregnant with their first child. The result was the birth of Blackagar (see Black Bolt), the most powerful Inhuman ever. Agon and Rynda persuaded their siblings to expose their unborn children to the Mists as well, resulting in the creation of the unique,

high-powered Royal Family.

Twenty years ago the Kree rediscovered their long forgotten experiment and attempted to reassert their control with the help of Maximus, Blackagar's younger brother. Blackagar exposed Maximus' plot and destroyed the Kree. Auran and Rynda were killed when the Kree ship crashed on their lab; Blackagar was elected to replace them as the new king.

Blackagar's reign has seen the most rapid change the race has ever undergone. The outside world had finally developed to the point where it could be a threat. Under Blackagar's guidance, the Inhumans developed the technology to move their city intact to the Himalayas. Maximus temporarily overthrew Blackagar and drove the Royal Family into exile on several occasions. The greatest change came when the Inhumans discovered they had a severe allergy to the pollutants created by modern industry. With the FF's help, the Inhumans moved their city to the Blue Area of the Moon.

The current culture is vital and thriving again: Genetics dominates its every aspect. The Inhumans practice strict population control that has kept their numbers around 1230 for millennia. Their religion involves ancestor worship rather than deity worship. Their main professions are science-related. There is a small militia of 50 people, but in a war the entire population is mobilized. Inhumans speak their native language, Tilan, and some of the more popular languages, including English, Russian, and Chinese.

## INHUMAN

F	GD	(10)	Health: 80
A	EX	(20)	
S	EX	(20)	Karma: 30
E	RM	(30)	
R	GD	(10)	Resources: varies
I	GD	(10)	
P	GD	(10)	Popularity: varies

### KNOWN POWERS:

Each Inhuman has a single power of Feeble to Remarkable rank. When creating an Inhuman, any resultant non-human appearance may take the place of any actual power.

The Inhumans are considered to be Mutants of the Induced or Breed types. Their actual appearance may be Human, Humanoid, Modified Human with extra parts, Demihuman, or Animal/Alien.

**CONTACTS:** The Inhumans are known in the outside world. Good Inhumans have contacts with the FF and the Avengers. Evil Inhumans may have contacts with the Kree or various human super-criminal organizations.

**RUNNING AN INHUMAN:** Inhumans are an extremely close tribal family. Their devotion to their city and race is unshakable. Those who turn against Attilan are therefore extremely evil, corrupt individuals.



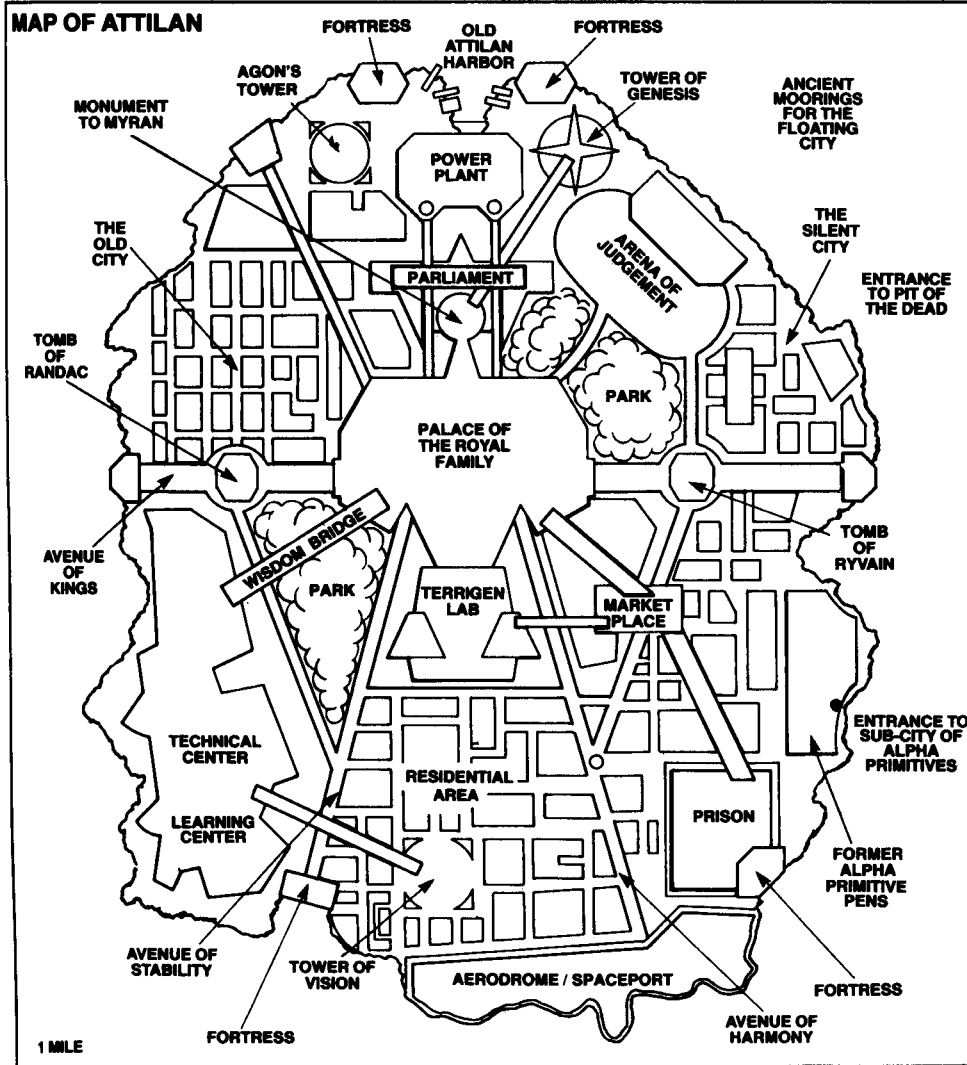

## ATILAN

Attilan is the ancestral city of the Inhumans and their servant race, the Alpha Primitives.

It was originally an island 200 miles southwest of Iceland. At that time the island was a part of the continent of Atlantis. The Inhumans managed to retain both their political and physical independence from the Atlantean Empire. The physical independence was achieved by cutting Attilan free of its bedrock and converting it into a natural barge. Thus when Atlantis sank, the tiny island remained on the surface. Over the millennia, the Inhumans added propulsion units to drive their island through the ocean. One hundred years ago, they even added anti-gravity drives powerful enough to move the island through air or space.

Attilan is a roughly circular city one mile in diameter resting on a hemispherical chunk of volcanic rock. It contains a series of large

chambers that have been modified to serve various purposes. The surface city has been demolished twice and rebuilt. In its current form it is an interlocking series of towers. Most buildings have Amazing material strength; the fortresses have Monstrous material strength.

When Attilan was moved to the Himalayas, it sat in an artificial valley three miles above sea level. During this period it was known as "The Great Refuge."

Attilan currently rests in the hospitable Blue Area of the Moon. Its landing crushed many of the ancient Kree ruins, including the site where the X-Man Phoenix destroyed herself. However, most of the Blue Area remains. Thus the Inhumans now have room to grow. Whether they do so remains to be seen.

## BLACK BOLT

Blackagar Boltagon

F	EX	(20)	Health: 130
A	IN	(40)	Karma: 60
S	RM	(30)	Resources: MN(75)
E	IN	(40)	Popularity: 15
R	EX	(20)	(95 among the Inhumans)
I	EX	(20)	
P	EX	(20)	

### KNOWN POWERS:

**Energy Conversion:** Black Bolt can harness electrical energy and transform it into energy for his other powers. He possesses this at Unearthly rank. This power functions automatically, gradually accumulating a "charge" that he can release at will. Black Bolt can absorb electrical attacks of up to Unearthly intensity but he must release that energy within ten turns.

**Hyper-Strength:** Black Bolt can channel his powers into himself and temporarily raise his Strength to Monstrous rank (+3CS for 1-5 rounds).

**Electrical Generation:** Black Bolt can release electrical blasts of Monstrous damage and range.

**Vibration:** He has the ability to cause C1000 damage at power rank range by simply speaking. The effects vary from Excellent rank (the area quakes) to full strength (the target explodes).

If Black Bolt whispers, he causes Shift-Y brute force damage to everything within 10 areas. Conversational speaking causes Shift-Z damage within 20 areas. Shouting causes full, C 1000 damage to everything within 50 areas. This is sufficient to completely destroy Attilan.

**Force Field Generation:** He can create a force field of 1 area in size with Monstrous rank protection.

**Magnetism:** He can create a shockwave of electromagnetic force that has Monstrous range and damage against electronic devices.

**Energy Solidification:** He can create masses of "solid" energy that have Monstrous material strength and last for 1-10 turns. Use of this power exhausts Black Bolt for an additional 1-10 turns.

**True Flight:** He can fly at Monstrous speed (450 mph).

**Energy Detection:** He can detect electrical or magnetic signals with Monstrous ability.

**WEAKNESS:** Black Bolt's power is primarily controlled by the same area of the brain that controls speech. Because of this, Black Bolt cannot speak without automatically releasing his most destructive powers. If Black Bolt is muzzled, his Vibration power is reduced to Remarkable.

The fork-like antenna on his forehead enables Black Bolt to use his other powers. If the fork is damaged or missing, he cannot use any



power except Vibration.

**TALENTS:** Black Bolt is a born Leader.

**CONTACTS:** Black Bolt is the leader of the Inhumans. He is an ally of the FF and the Avengers.

**BACKGROUND:** Blackagar Boltagon is the oldest son of Agon and Rynda, the former rulers of Attilan. He acquired his power when the pregnant Rynda exposed herself to the Terrigen Mists. This gave him greater powers than any previously possessed by an Inhuman. Unfortunately, the powers were beyond young Boltagon's control. He was isolated until he was 19. Soon after his release, he foiled his brother's plot to betray the Inhumans to the Kree. Unfortunately, he also accidentally killed his parents. Despite his protest, he was elected the new king.

Black Bolt fell in love with his cousin, Medusa, and joined her in the traditional lengthy engagement. They married a short time ago and are currently expecting their first child.

**RUNNING BLACK BOLT:** Black Bolt has complete self-control and never acts rashly or in anger because he knows the dreadful consequences of such an act. He is a firm believer in honor and personal integrity. Occasionally he does like to get away from the pressures of leadership; at such times he will don a disguise and journey to Earth.

## MAXIMUS

F	GD	(10)	Health: 70
A	GD	(10)	
S	EX	(20)	Karma: 80
E	RM	(30)	
R	IN	(40)	Resources: IN(40)
I	GD	(10)	
P	R M	(30)	Popularity: -30

### KNOWN POWERS:

*Mind Control:* Maximus has the Incredible ability to psionically control the minds of others. He can control their thoughts and actions by overriding their own conscious minds. Although he can affect everyone within his range, he can only induce a single effect at a time. The effects last until the victim is freed from his influence. He has developed his power into these stunts:

- Possession—the victim obeys Maximus' every thought.
- Induced Amnesia—By concentrating on a single victim, he can cause total amnesia (a red FEAT).
- Mind Transferral—He may switch his mind with another person's. That other person is then trapped comatose in Maximus' body. It is unknown if Maximus could use this power to survive the death of his own body.
- Invisibility (Telepathic)—Maximus can alter the minds of people in the area so that, although they can see him, they immediately forget his presence.

**TALENTS:** Maximus is a genius in the fields of genetics, engineering, and physics. He has created a number of useful, albeit nasty, inventions and beings.

**CONTACTS:** Maximus is willing to sell the Inhumans to his contacts the Kree and the Enclave.

**BACKGROUND:** Maximus is the younger son of Agon and Rynda. He received his powers when he was exposed to the Terrigen Mists as an infant, but the powers did not emerge until he was an adolescent. When Black Bolt accidentally killed his parents, a side-effect caused Maximus to lose his sanity and powers. Over the years, Maximus had to invent devices that would enable him to seize control. By mutating three Alpha Primitives into the Trikon, he seized control and drove the Royal Family into exile. When Black Bolt returned several years later, a battle between the brothers demolished Attilan's ancient buildings. Maximus' second coup lasted only a few hours. When Maximus' long-dormant psionic powers began to appear, Black Bolt recognized them and immediately acted. He placed Maximus in suspended animation. He did not explain why. Gorgon was offended by this and freed Maximus, who immediately destroyed Black Bolt's memory. Eventually Black Bolt's memory was restored and Maximus again imprisoned.

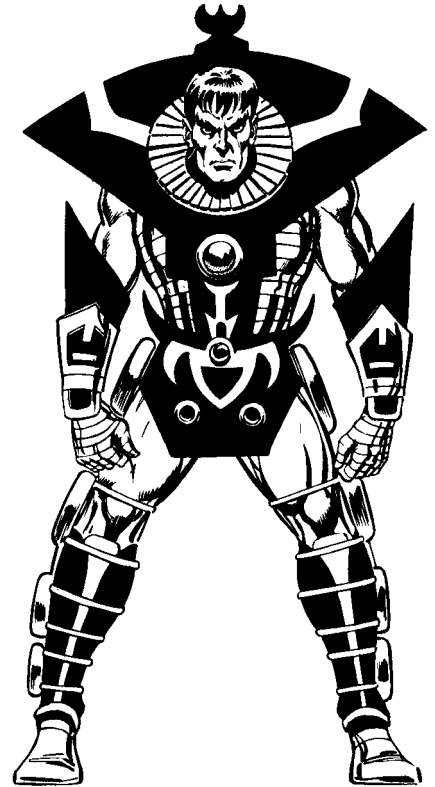

Maximus pulled his fourth coup when most of the Royal Family were away on business; this time he was defeated by his cousins Triton and Karnak, but not before Black Bolt again demolished the city.

Maximus next sought the aid of the Enclave to overthrow Attilan. Unfortunately, his unrequited passion for Medusa made him stop the coup himself. As a side effect, Maximus was thrown into a death-like trance and placed in a tomb beneath Attilan. When the Inhumans relocated to the Moon, Maximus came into contact with a Kree power crystal. This enabled him to transfer his mind and Black Bolt's. This secret coup lasted for months until it was discovered. Maximus is back in his body and still in solitary confinement.

**RUNNING MAXIMUS:** Maximus is obsessed with becoming king of the Inhumans. He will try anything short of the complete destruction of the race to get his way (destroying half of the race is acceptable, though). Maximus will gleefully ally himself with anyone who can help him achieve his goal.





## GORGON

F	RM	(30)	Health: 120
A	GD	(10)	
S	RM	(30)	Karma: 26
E	AM	(50)	
R	TY	(6)	Resources:EX (20)
I	GD	(10)	
P	GD	(10)	Popularity: 6 (80 among Inhumans)

### KNOWN POWERS:

**Vibration:** Gorgon has the Amazing ability to create tremor-like damage. The power is emitted by his highly developed legs and feet either stomping nearby or kicking a target. He has a maximum range of 20 areas.

**Modified Human (Muscular/Skeletal):** Gorgon has extremely well-developed legs and feet. His legs' muscles and bones are stronger than normal, even for an Inhuman. His feet resemble hooves. These unique modifications give Gorgon useful Power Stunts.

- Gorgon has Monstrous Endurance when determining the effects of slams, stuns, or being knocked off his feet while in combat.
- Gorgon's legs give him Amazing body armor in resisting the harmful effects of a fall. This protection applies to anyone Gorgon is carrying as well. Because of his low center of gravity, Gorgon always lands on his feet unless he is tied up.

**TALENTS:** Gorgon is the City Administrator of

Attilan. He has Good Reason when dealing with the bureaucratic mind. He is trained to pilot Attilanean aircraft.

**CONTACTS:** Gorgon is a member of the Royal Family of the Inhumans. He is an ally of the FF and the Avengers.

**BACKGROUND:** Gorgon is the only son of Korath and Milena and nephew to King Agon of the Inhumans. Like most of the current Royal Family, Gorgon was exposed to the Terrigen Mists prenatally. Korath and Milena were killed during Maximus' first coup. Gorgon joined the Royal Family in exile. Together they searched for the missing Medusa. Gorgon was the first to find her. Since she was suffering from amnesia, she mistook him for an enemy and he was forced to battle her and the FF before the mistake could be corrected.

After Maximus was deposed, Gorgon became Attilan's staunchest defender. Despite his friendship with his cousin, Black Bolt, Gorgon always watched him for signs that he too might go mad and betray Attilan. When Black Bolt inexplicably placed Maximus in suspended animation, Gorgon worried that this might be happening. In his quest to understand why Black Bolt had acted as he did, Gorgon released Maximus and accidentally set the stage for Maximus' next coup. Since that time, Gorgon has ceased to question Black Bolt's actions.

**RUNNING GORGON:** Gorgon is a short-spoken, quick-acting man who readily uses his power at the first provocation.

## TRITON

F	GD	(10)	Health: 110
A	RM	(30)	
S	RM	(30)	Karma: 40
E	IN	(40)	
R	GD	(10)	Resources: EX(20)
I	GD	(10)	
P	EX	(20)	Popularity: 6 (80 among Inhumans)

### KNOWN POWERS:

**Demihuman body (Piscean):** The Terrigen Mists gave Triton's body a fish-like appearance. Although his overall body shape remains human, his epidermis is covered in fine, green scales and his internal organs are modified to meet the needs of an aquatic existence. This new body also gives Triton his powers.

**Water Freedom:** Triton's body is perfectly adapted for life at any depth of the ocean. He can move through the water as effortlessly as a surface-dweller can move through the air. His body can alter its own pressure to match that of whatever depth Triton is in. He has Good resistance to cold. His eyes are adapted



to focus either in the air or underwater. **Hyper-Swimming:** Triton can swim with Typical speed.

**Water-Breathing:** Triton primarily is a water-breather, although he can act as an amphibian for extremely short durations.

**WEAKNESS:** Since Triton is a water-breather, he must have a fresh water supply in order to leave the water. Normally his needs are supplied by the magenta tubes that line his body. These tubes refilter the water, spread it across his torso, and supply it directly to his neck gills. If this device is damaged or missing, Triton begins to suffocate. After 15 turns, and at each turn thereafter, he must make an Endurance FEAT to retain consciousness. Normally a yellow FEAT is required. Humid conditions lessen it to a green FEAT while and conditions raise it to a red FEAT. In addition, Triton loses one point of health per turn he is out of the water. This damage is automatically healed as soon as he immerses himself. (Note that these effects are quite different from those suffered by the Sub-mariner)

**TALENTS:** Triton is a master of underwater combat. When fighting underwater, his Fighting rank increases to Excellent.

**CONTACTS:** Triton is a member of the Inhuman Royal Family. He is an ally of the FF, the Avengers, the Sub-mariner, and Stingray.

**BACKGROUND:** Triton is the oldest son of Mander and Azur. His exposure to the Terrigen Mists on his first birthday transformed him into his present aquatic form. Azur raised him in a special aquatic alcove on Attilan's shore. As he became older, he created his own position of undersea scout. It was his capture by fishermen that prompted Attilan's removal to the Himalayas. There he had to trade an ocean for a pool. With Attilan's move to the Moon, Triton's aquatic realm increased in size when he discovered the remains of the Kree's culvert system. He also discovered and destroyed a Kree artifact that caused everyone to experience extremely realistic and deadly fantasies.

**RUNNING TRITON:** Triton is torn between his love of the ocean and of Attilan. Although he is a loyal protector of his home on the moon, he finds every possible reason to return to Earth's oceans.

## KARNAK

F	AM	(50)	Health: 130
A	EX	(20)	
S	RM	(30)	Karma: 60
E	RM	(30)	
R	GD	(10)	Resources: EX (20)
I	AM	(50)	
P	EX	(20)	Popularity: 9 (80 among Inhumans)

### KNOWN POWERS:

**Martial Arts Supremacy:** Karnak does Amazing damage when using the unarmed Martial Arts. He can use this powerful skill to do power rank damage to any target he strikes.

**Weakness Detection:** Karnak has the Good ability to locate the weakest points in bodies or physical structures. This combines with his Martial Arts Supremacy to give him the following Power Stunts:

- Karnak may inflict Unearthly damage if he makes a successful Psyche FEAT after studying the target for one turn.
- Karnak may slam or stun opponents whose Endurance is greater than his Strength. He may ignore the effects of the opponent's armor, resistance, or invulnerability if he makes a Psyche FEAT.

**Iron Will:** Karnak has Amazing control over his own body. He can control his body autonomic functions of breathing, reflexes, heartbeat, and even its reaction to pain or injury. Karnak can halt any of these processes indefinitely. He gains a + 1 CS in all Endurance FEATS involving poisons or knock-out gases.

**TALENTS:** Karnak is a philosopher and a scholar specializing in the study of martial arts. He possesses Martial Arts A, D, and E, as well as Wrestling and Acrobatics.

**CONTACTS:** Karnak is a member of the Inhuman Royal Family. He is an ally of the FF and



the Avengers.

**BACKGROUND:** Karnak is the younger son of the Inhuman priest-philosopher Mander and the biologist Azur. When Karnak's older brother Triton developed a reptilian skin after exposure to the Terrigen Mists, his parents decided not to expose young Karnak to it. Zmak was trained in various mental and physical disciplines, with the result that he attained formidable powers of a sort.

**RUNNING KARNAK:** Karnak is a quiet, soft-spoken man who always studies everything in his vicinity. He never acts rashly.

## LOCKJAW

F	RM	(30)	Health: 132
A	FE	(2)	
S	AM	(50)	Karma: 32
E	AM	(50)	
R	TY	(6)	Resources: EX(20)
I	TY	(6)	
P	EX	(20)	Popularity: 10 (70 among the Inhumans)

### KNOWN POWERS:

**Gateway:** Lockjaw has the Unearthly ability to create dimensional shortcuts that can span 2.5 billion miles. These gateways can instantly teleport Lockjaw and anyone in contact with him. He locates his target sites by using his

Tele-Location power (below). In an emergency, Lockjaw can instinctively jump to the location of either Attilan, the FF's headquarters, or the Thing himself.

**Telelocation:** Lockjaw has the Shift-Y ability to psionically locate anyone within his range (250,000 miles). If the person is well-known to him, the range extends to near-infinity. Such cases are limited to the Royal Family and the Thing.

**Animal Body:** Lockjaw resembles an elephantine bulldog. Because of this, most people assume he is merely an animal. Lockjaw's hands are useless for handling objects. Instead, he used his immense mouth as a manipulative organ.

**TALENTS:** Lockjaw is a born explorer and has an excellent knowledge of Earth's geography. He also has psychiatric skill concerning the psychology of the severely deformed.

**CONTACTS:** Lockjaw is a member of the Inhuman Royal Family, an ally of the FF, and a special friend of the Thing.

**BACKGROUND:** Lockjaw is very tightlipped about his past. He acquired his powers and animal-like appearance when he was exposed to the Terrigen Mists as a child. He developed a special friendship for Crystal and was usually in her company, so much so that he was often referred to as "Crystal's dog." When the Royal Family was driven into exile, Lockjaw joined them. His power enabled them to carry out the long search for Medusa.

Lockjaw's human birth was a secret kept from all outsiders until Lockjaw himself revealed it to the Thing and Quicksilver. Quicksilver had been about to expose his daughter Luna to the Mists when Lockjaw spoke and asked Quicksilver if he wanted to risk his daughter's looking like Lockjaw. Quicksilver understood and agreed not to risk Luna's future. After that, Lockjaw began to hang around with the Thing; they see each other as fellow spirits.

**RUNNING LOCKJAW:** Lockjaw maintains the public misconception about him and usually often acts like an extremely intelligent animal. Although he can speak, he rarely does so. He explains his silence with, "I didn't have anything to say." Lockjaw feels sympathy for anyone with a grotesque appearance and will do whatever he can to make that person's life easier, even if this means taking the person

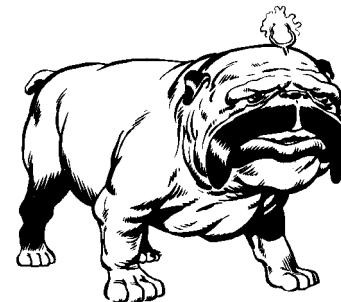

back to Attilan.

## ALPHA PRIMITIVES

F	TY	(6)	Health: 66
A	TY	(6)	
S	RM	(30)	Karma: 6
E	RM	(30)	
R	FE	(2)	Resources: FE(2)
I	FE	(2)	
P	FE	(2)	Popularity: 1

**BACKGROUND:** The Alpha Primitives are a cloned race of menial laborers. They were created by the Inhuman scientist Avadar to serve as brute laborers to handle the necessary but odious duties of sanitation, food production, manufacturing, and so on. They were intended to be docile creatures with simple thoughts. They are all sexless and identical (5'7", green eyes, and completely hairless).

Maximus has twice used the Alpha Primitives as a tool in his quest for power. In his first attempt, Maximus used a concentrated form of the Terrigen Mists to transform three A-Ps into the Trikon. In his second attempt, Maximus used the collective guilt felt by the Inhumans towards the Alpha Primitives. He constructed the android Omega to feed on that guilt. Omega was defeated when the Inhumans finally released the Alpha Primitives from servitude.

Since that time, the Inhumans have ceased to create new Alpha Primitives and have begun to take responsibility for their own manual labor. The Alpha Primitives were released into a separate city beneath Attilan where they are slowly dying out.

**RUNNING ALPHA PRIMITIVES:** Alpha Primitives are simple-minded and obedient. They can only deal with a single command at a time.

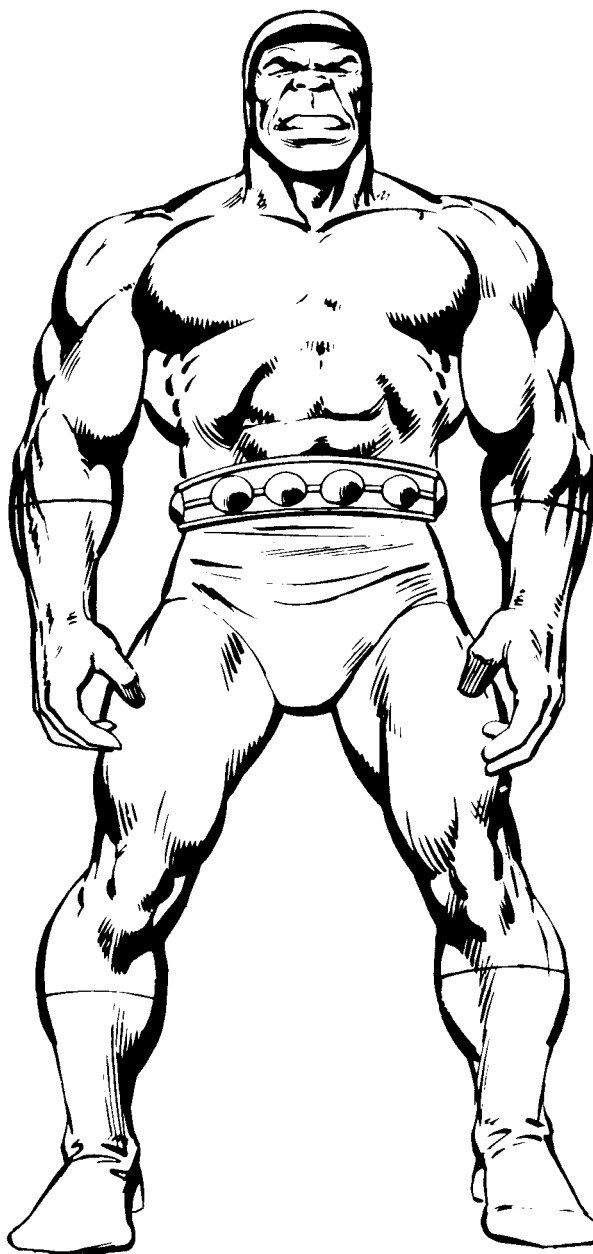



## ATLANTIS

The term "Atlantis" refers to a series of city-states that existed on Earth's surface or at various locations beneath the Atlantic Ocean. In the Marvel Universe, Atlantis was the earliest human civilization. It was located on a continent that filled most of the present-day North Atlantic. It was settled in 19,000 B.C., four thousand years after the last Ice Age. Although they came to the land as barbarians, the Atlanteans soon developed a high level of culture and science.

Among their neighbors were the reclusive race of Inhumans on nearby Attilan and the Lemurians on their island-continent in the Pacific. The Atlanteans and the Lemurians fought a war that eventually resulted in the decimation of both lands. The Atlanteans accidentally destroyed their own land through the misuse of the volcanic pits that heated the land. The Lemurians were destroyed immediately thereafter by the alien race, the Celestials.

There were survivors of the Great Cataclysm. The island of Attilan had already be-

come free floating and thus remained afloat as the surrounding land sank. The southern city of Netheria had been covered by a watertight plastic dome by far-thinking city leaders. Many groups survived on the remaining islands or managed to sail to the other continents.

Ten thousand years ago, the new race of Homo Merminus appeared. The origins of the race are unknown. While individual members of human-derived races (such as the Eternals, Deviants, and Inhumans) possessed forms of water-breathing, an entire race of such beings was completely new. Possible explanations range from the Atlanteans' own myth that Poseidon created their race to the anthropological theory that the new race was a product of genetic experimentation by a more advanced race like the Celestials, Deviants, Eternals, or Inhumans.

The original people were nomads who walked along the ocean floor carrying giant shells for protection from sea monsters. In 6000 B.C. the nomads settled in the ruins of Atlantis' lost capital (due west of England and south of Iceland). A series of new cities rose and fell by disaster and invasion. A group of

the new Atlanteans left for the hopefully more peaceful Pacific and settled in the ruins of Lemuria.

Little is known of the millennia that followed. It is believed that Poseidon dwelled among them in mortal form, both protecting his "children" and promoting the Poseidon worship that continues today. In the 18th century, the Atlanteans discovered the Deviants and their technology. Around 1800 the entire city moved to a new site under the Ross Ice Shelf bordering Antarctica.

Throughout the ages, the Atlanteans had only fleeting knowledge of the surface-dwellers. The two races met in the 1920s when an American icebreaker accidentally damaged sections of Atlantis. In the confused period that followed, Namor was conceived. (See Sub-mariner, below).

In the late 1940s, Atlantis was destroyed by the super-villain Destiny. The people dispersed through the sea for decades until they were reunited by Namor. The next years were tumultuous. The Atlanteans waged war three times on the surface-dwellers. Because of their belligerence, Atlantis was repeatedly

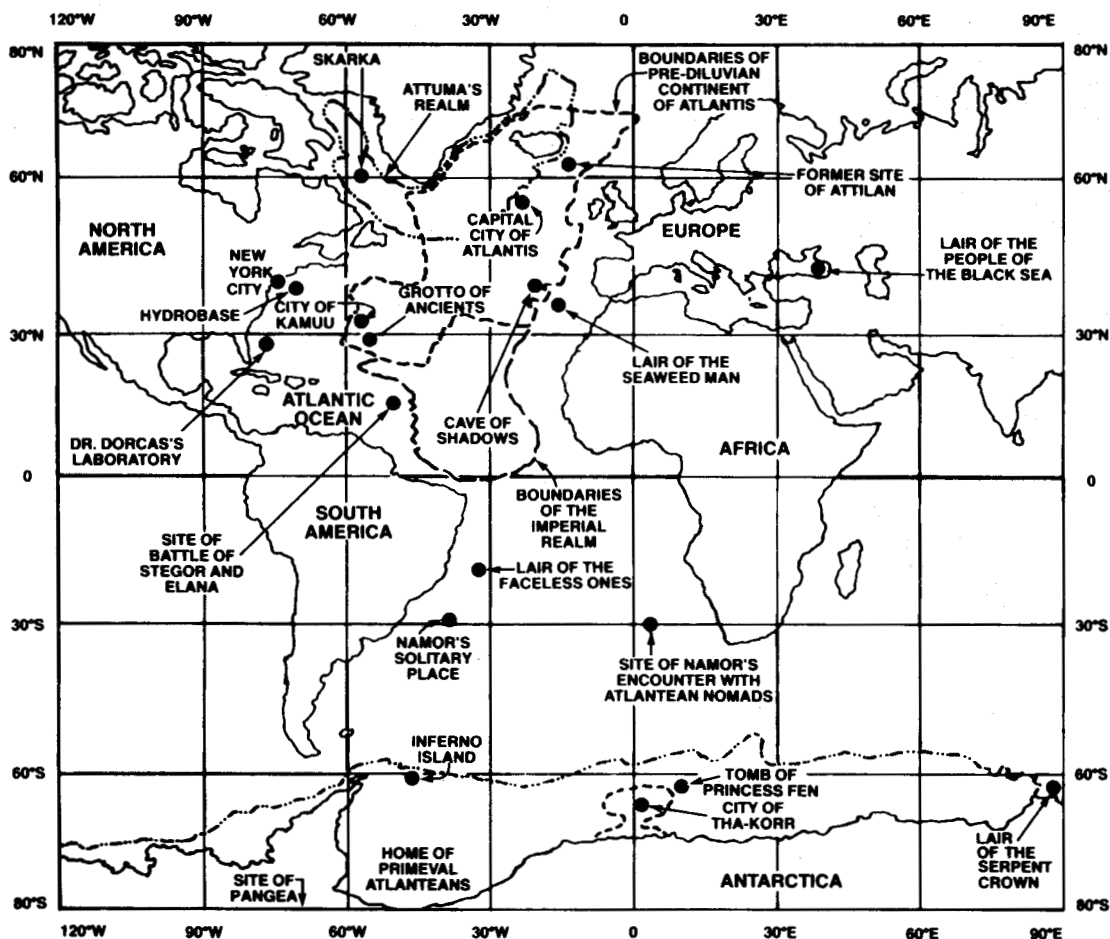

denied membership in the United Nations. Disaster from a new quarter struck when an accidental nerve-gassing threw the citizens into suspended animation. They were later revived by Namor and Dr. Doom. This last disaster led to the people petitioning Namor to relinquish the crown, which he did. Atlantis is currently ruled by Namor's former vizier, Lord Vashti.

## CITY OF TOADS

An air-filled, subterranean city located between Hawaii and Australia. It is home to the Deviants.

## HYDRO-BASE

This artificial island was the headquarters of Dr. Hydro and later the temporary home of the Hydro-Men. It is now the home and headquarters of Stingray. The Avengers and FF house their long-range vehicles here. A shuttle tube connects Hydro-base with Manhattan.

## KAMUU

This is the original capital city of the surface continent of Atlantis. Later it was rebuilt by Homo Mermanus to become the first aquatic city to be called Atlantis.

## MARITANIS

The second most populated modern Atlantean city. Home to Namora and birthplace of Namorita. It was destroyed by a nuclear weapons test conducted by surface humans.

## NAGA'S CITY

This is the capital city of the Lemurian branch of Homo Mermanus. It is located a few hundred miles southwest of Hawaii.

## NAMOR'S SOLITARY PALACE

In the period between Namor's recovery of his memory and the reunification of the Atlanteans, Namor established a retreat off the coast of Brazil.

## SKARKA

This underwater realm is located in the depths of Baffin Bay between Greenland and Canada. It is home to the nomadic warrior tribe ruled by Attuma.

## THA-KORR

This is the city built by the Atlanteans after they left the North Atlantic. Namor was born here. Tha-Korr was destroyed by Paul Destine.

## ATLANTEANS

### Homo Mermanus

F	GD	(10)	Health: 100
A	GD	(10)	
S	IN	(40)	Karma: 40
E	IN	(40)	
R	GD	(10)	
I	GD	(10)	
P	EX	(20)	

### KNOWN POWERS:

*Humanoid Race:* Homo Mermanus is an early off-shoot of the Human Race. They have pointed ears, angled eyebrows, and blue skin.  
*Water Freedom:* All Atlanteans are adapted for life in any section of the oceans.  
*Water-Breathing:* All Atlanteans breathe water; salt water is preferred. Most can only breathe water and suffocate if they are exposed to air. There are a few amphibious Atlanteans who usually also possess Caucasian rather than blue skin.  
*Hyper-Swimming:* Atlanteans can attain Poor speeds (30 mph).

**BACKGROUND:** The term "Atlanteans" refers to Homo Mermanus, the water-breathing branch of humanity that suddenly appeared ten thousand years ago. Atlanteans are nearly identical to surface-dwelling humans. Their anatomy and physiology have been modified to enable them to thrive in the frigid ocean depths. They possess gills located on the neck just above the clavicle. Their eyes are sensitive to blue-green light and can correct the natural refraction of light underwater; these adaptations enable them to see easily underwater. Their mostly vestigial lungs contain small air sacs that give them enough buoyancy to swim; the air can be released or reabsorbed by the lungs to enable the Atlanteans to swim at any depth.

Despite the differences, their genes remain close enough to surface humans to allow fertile interbreeding. The result is a pink-skinned, amphibious hybrid. Due to an unknown factor in King Thakorr's DNA, if any of his descendants mates with a surface-dweller, the resultant hybrid also possesses small wings on the ankles that enable that person to fly.

The Atlantean social and technological levels are roughly equal to that of Caesar's Rome. They are primarily a hunter-gatherer culture with limited technology and science. What high technology they possess was developed with the assistance of knowledge learned from the Deviants.

**RUNNING ATLANTEANS:** Atlanteans are generally loyal to their tribe or city. They have a slight hostility towards other, more distant branches of Homo Mermanus, and extreme xenophobia in regards to the surface dwellers.

## PROMINENT ATLANTEANS

**ANDROMEDA** a warrior and adventurer who died valiantly with the Defenders.

**ARKUS** a military officer.

**BYRRAH** Namor's cousin and a renegade.

Byrrah aided Llyra in attempting to overthrow Namor and was a party to Dorma's death.

**CORAL** an Atlantean citizen.

**DARA** Namor's male cousin.

**DORMA** Namor's Royal Consort and fiancée.

She was the peacekeeper between Namor and the FF. She was killed by her kidnapper, the Lemurian villainess Llyra.

**DRAGONRIDER** a masked outlaw.

**FEN** King Thakorr's daughter and Namor's mother. She died when Destiny destroyed Atlantis.

**IKTHON** An Atlantean scientist who later joined Byrrah and Krang in an attempt to seize power in Atlantis.

**KORMOK** High Priest of the Temple of Neptune.

**KRANG** Warlord of Atlantis. He was leader of the Atlantean militia and protected the people



from the hostile nomads that roamed the ocean depths. He became engaged to Dorma while Namor was an amnesiac. When Namor returned and reclaimed Dorma, Krang became his enemy. He once overthrew Namor in a military coup and later allied himself with other renegade Atlanteans like Byrrah or with surface-dwelling super-villains like the Puppet Master and the Frightful Four. For a time, Krang possessed the Serpent Crown.

**LORVEX** A barbarian warrior.

**MADONN** an elder statesman.

**MERANNO** (a.k.a. *U-MAN*) an Atlantean who aided the Nazis during WWII.

**NAMORA** Namor's cousin and an amphibious hybrid, although she lacked the characteristic winged ankles. She was Namor's childhood companion. She was later killed by Llyra, a Lemurian.

**NAMORITA** Namora's daughter. She resembles her mother but possesses the rare ankle wings.

**ORKA** Renegade turned supervillain.

**PROTEUS** a renegade Atlantean who also possessed Shape-Shifting, not to be confused with a similar X-Man villain of the same name.

**RAMAN** The official gatekeeper for Atlantis.

**SETH** Namor's advisor, now deceased.

**THAKORR** Former King of Atlantis; Namor's grandfather and Namorita's great-grandfather. He was killed when Destiny destroyed Atlantis.

**THAKOS** Krang's replacement as Atlantean Warlord.

**TYRAK** Krang's lieutenant.

**VASHTI** Former Grand Vizier and current King of Atlantis.

**VOLPAN** a technician.

## ATLANTEAN EQUIPMENT

The devices used by Atlanteans fall into three categories-scavenged material recovered from sunken wrecks, high tech items derived from Deviant science, and bio-genetic tools created by long centuries of controlled breeding.

Since the Atlanteans had access to the ruins of the original Atlantis and to everything that ever sank in the Atlantic, they were able to acquire a variety of useful materials, especially forged metals and ceramics. Although they manufacture their own clothing from sea-based sources, they frequently pattern it after whatever they found in the wrecks.

Deviant science was primarily interested in warfare and genetic manipulation. Consequently, the knowledge the Atlanteans acquired was all somehow war-related. They acquired the ability to forge weapons-grade metals under water, to design and build energy weapons, and to create watercraft that could also function on the surface. The sciences of medicine and pharmacology are unknown except for the discovery of a variety of serums that enable an Atlantean to breathe air safely.

The Atlanteans were able to control the monsters found in the depths and to further

breed them for specific purposes. These animals came to serve as living equivalents for manufactured items from the surface (for example, tanks and landing craft). This breeding program has been going on for millennia.

## SPECIFIC ITEMS

**WATER-BREATHING SYSTEM:** When a non-amphibious Atlantean ventures into the surface world, he needs this system: A sealed bubble helmet that covers the head and neck-gills. The helmet is designed to enable the wearer to see normally. A small cylindrical backpack recycles and renews the water. The system enables the wearer to stay away from the water for days before they suffer ill effects.

**ONE-MAN PROPULSION SYSTEM:** This is a small cylindrical platform that clamps to the user's feet. It is steered by flexing the feet and legs. It can maintain Excellent speed (75 mph) for two thousand miles in -the water. Its usefulness in the air is limited to a short hop of ten to twenty feet (enough to get onto a dock or the shore).

**PROTEUS HORN:** This large horn is the only recorded way to summon and control the larger sea monsters such as Giganto. All that is known of the Horn's origin is that it was a gift of the early Atlanteans. The Horn resembles a three-foot long spiral shell. It has Amazing Material Strength.

**TURTLE TRANSPORTS:** These gigantic turtles are bred to carry troops on their back across great distances. The turtles are amphibious and can function equally well in or out of the water. Movement is Good in the water, Feeble out of it. Their shells have Incredible Material Strength. Their stats are:

F	GD	(10)	Health: 102
A	FE	(2)	
S	IN	(40)	Karma: 2
E	AM	(50)	
R	Shift 0		
I	FE	(2)	
P	Shift 0		

## GIGANTO

F	TY	(6)	Health: 408
A	FE	(2)	
S	Y	(200)	Karma: 50
E	Y	(200)	
R	Shift 0		
I	GD	(10)	
P	IN	(40)	

### KNOWN POWERS:

**Armor Skin:** Giganto's leathery hide gives him C1000 resistance to external attacks. Unfortunately, his interior flesh has normal, Typical material strength.

**BACKGROUND:** This is a gigantic behemoth used by the Atlanteans as a biological equivalent of a doomsday weapon. Giganto is two thousand feet in length; when walking it

stands 1000 feet tall. Its weight is unguessable; in game terms a Strength FEAT of Shift-Z is needed to lift it. It resembles an anthropoid version of a sperm whale. Namor called Giganto "the largest living thing in all the world" (no one contests the claim). Giganto normally stays in hibernation in a cave on the ocean floor. Once summoned, Giganto can be directed to attack any region until Giganto pounds it flat.

Giganto has one fatal problem, its need for rest. Giganto can only function for one hour on the surface before he must sleep for another 23 hours. He sleeps with his mouth open, thus exposing his vulnerable interior. The first Giganto was destroyed when the Thing carried an atomic bomb into Giganto's stomach. The blast vaporized Giganto's internal organs though it did not penetrate his armored hide.

Creatures like Giganto take centuries to reach maturity. They are slow to reproduce. Several immature young Gigantoes remain hidden somewhere in the ocean. They are smaller (500 feet long) and less powerful than their parent (Strength and Endurance are Unearthly).

## SUB-MARINER

### Namor of Atlantis

F	IN	(40)	Health: 185
A	RM	(30)	
S	MN	(75)	Karma: 76
E	IN	(40)	
R	TY	(6)	Resources: MN(75)
I	RM	(30)	
P	IN	(40)	Popularity: 5 (80 to Atlanteans)

### KNOWN POWERS:

**Humanoid Race:** Namor is a human-Atlantean hybrid. His mother was a member of the Homo Mermanus race. As such, Namor has certain inherited powers.

**Water Freedom:** Namor is completely adapted for life in any section or depth of the sea. He has Excellent resistance to Cold.

**True Invulnerability:** To better withstand the pressures of the oceans' depths, Namor's flesh provides Good protection against physical attacks.

**Water-Breathing:** Like all Atlanteans, Namor can breathe water. However, he retains the ability to breathe air as well.

**Hyper Swimming:** Namor can attain Typical speed (45 mph).

**Winged Flight (Modified Human/Extra Body Parts):** Namor has a pair of small wings growing from each of his ankles. Despite their small size, they give him Poor Flight (40 mph). As a Power stunt, he can lend his Strength to the wings' lift, enabling him to lift about two tons.

**Electrical Generation:** The Sub-mariner is capable of generating electrical energies much the same as electric eels. He can cause Remarkable damage to targets up to one area



away.

**WEAKNESS:** Finite Limit: Namor is amphibious. If he is removed from the water for an extended period, he begins to suffer ill effects. For every hour he is away from the water, or each turn he takes heat or fire damage, his Fighting, Strength, and Endurance ranks drop -1CS, until they all reach Typical rank. This decrease does not affect his Health. However, he suffers 30 points of damage to his Health for each day he is not totally immersed in water; he also cannot normally recover Health lost through other means.

**TALENTS:** As sovereign of Atlantis and its successor city-states, Namor has the Political skills of a king. He is an expert on Oceanography, Ichthyology, and the Atlantean sciences.

**CONTACTS:** Namor was king of the Atlantic branch of Homo Mermanus. He has been both an enemy and ally of the surface-dwelling humans. In the 1940s, he was a member of the All-Winners Squad and the Invaders superhero teams. In the modern world he is a founding member of the Defenders and a current Avenger. He has been both an enemy and ally of the FF. He and Sue have a special relationship that is usually described as platonic love but has occasionally been much more amorous. Through his wife Marrina he has contact with Alpha Flight.

**BACKGROUND:** Namor was born to the Atlantean woman, Princess Fen, and an American sea captain, Roger Mackenzie, in the 1920s. During the next two decades, Namor grew in the Antarctic Ocean, exploring both its depths and the few surface relics of the then-rare explorers. During one of his exploratory trips with his cousin Namora, he suddenly sprouted wings on his feet and discovered he could fly. Namor took to heart the Atlanteans' natural hostility to surface dwellers. When, he finally attained adulthood, he traveled to America to attack "the enemy" in its home ground. He was considered one of the first super-criminals and frequently fought the original Human Torch. However, Namor soon lost his hostility towards most air-breathing humans and directed his aggression against the Axis powers during WWII. He was romantically linked to the NYC policewoman, Betty Dean.

After the war, Namor encountered the Destiny, then the wearer of the Serpent Crown. Destiny used the Serpent Crown to destroy the Atlantean capital and to give Namor amnesia. Namor was sent to wander America's east coast as a vagabond and eventually settled in a skid row flophouse in NYC.

Namor was found by Johnny Storm, who reminded Namor of his old acquaintance, the original Torch. The rest of the FF helped Namor fully regain his memory. Unfortunately, soon thereafter, Namor returned to the Antarctic and discovered his home in ruins. He

declared war anew on the surface dwellers and the FF in particular. Oddly, this was also the time during which he and Sue fell in love. Eventually Namor reunited the Atlanteans, claimed the throne, and rebuilt Atlantis. In time, Namor again lost his hostility to the surface-dwellers. Until he recently joined the Avengers, he concentrated on protecting his people from outside threats and only occasionally dabbled in surface affairs.

Namor was engaged to the Atlantean noblewoman Dorma for a number of years. Following her death, Namor remained celibate until he met Marrina, another amphibious hybrid like himself. Their swift courtship resulted in marriage.

**RUNNING THE SUB-MARINER:** Namor is a complex individual. He will fight any war, no matter how lopsided, in the defense of Atlantis. When he was on his initial, youthful rampage against the surface dwellers, no atrocity seemed beyond him. However, in his later rampages in the modern era, Namor followed strict rules that could put him at odds to his ally of the moment. He is a firm believer in honor. If that erstwhile ally broke Namor's code of honor, Namor would switch sides and aid his former victim's escape.

Namor is a tempestuous man who will often act without considering the consequences. On the other hand, he retains a firm loyalty to past friends. When Reed and Sue were estranged, Namor covertly arranged to reunite them.

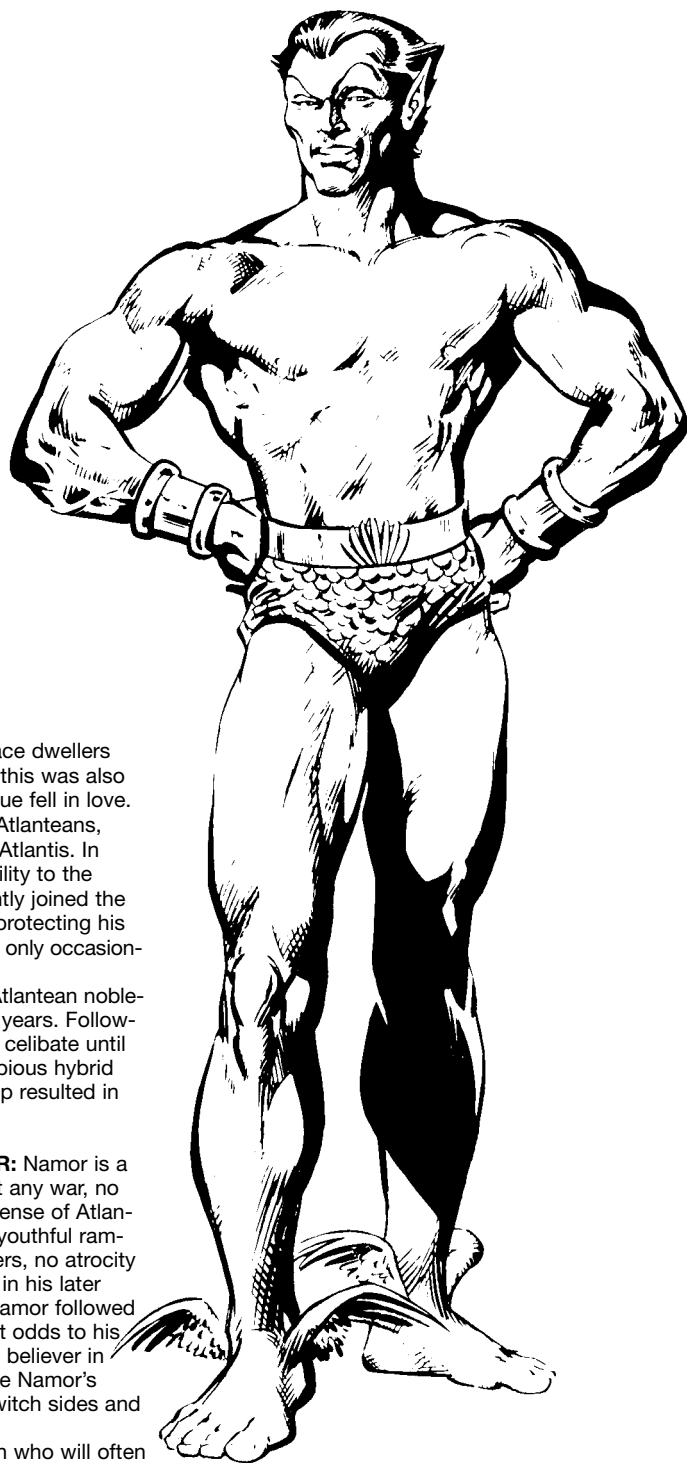



## LADY DORMA

F	GD	(10)	Health: 76
A	TY	(6)	
S	RM	(30)	Karma: 30
E	RM	(30)	
R	GD	(10)	Resources: GD(10)
I	GD	(10)	
P	GD	(10)	Popularity: 8

### KNOWN POWERS:

Dorma has the normal Atlantean powers and abilities.

**TALENTS:** Dorma is a skilled politician.

**CONTACTS:** Dorma was Namor's first fiancée. She could exploit his Contacts with the FF and Avengers.

**BACKGROUND:** The Lady Dorma was a member of the Atlantean aristocracy. She was born in the Atlantean city of Tha-Korr, under the Antarctic ice. She fell in love with the young Namor, but since his affections were tied to the NYC policewoman, Betty Dean, the love was unrequited. Dorma survived Destiny's destruction of Tha-Korr and roamed the ocean floor for decades. During that time she became engaged to Warlord Krang. When Namor returned, Dorma broke the engagement. Her love for Namor continued to go unrequited, as Namor was now obsessed with Sue Storm. Dorma was originally jealous of this relationship and she tried to drown Sue when the latter woman was an Atlantean captive.

It was a long time before Namor finally recognized Dorma's love and devotion. He finally realized this when Dorma was injured

helping him regain the Atlantean throne after Krang had seized it. From then on they were devoted to each other. Even when Dorma fell under the influence of the Serpent Crown, her love remained.

Tragically the consummation of that love resulted in Dorma's death. Shortly before they were to be married, Dorma was kidnapped by Llyra. It was Llyra who impersonated Dorma in the wedding ceremony in the hopes of laying claim to the Atlantean throne. When Llyra's identity was exposed, the Atlanteans decided that under their law, Dorma was now Namor's wife, even though she herself had not been at her own wedding. Llyra escaped Atlantis and returned to where she held Dorma. She smashed Dorma's water-filled cell and doomed her to suffocation. Namor arrived too late to rescue her.

**RUNNING DORMA:** Dorma was madly in love with Namor. She would do anything for him, even if he didn't realize at the time that her actions were in his best interests. In the early days of their relationship, Dorma stoically endured Namor's lack of affection. While she was originally jealous of Sue, she later became friends with her.

## NAMORITA

### Namorita Prentiss

F	EX	(20)	Health: 110
A	RM	(30)	
S	IN	(40)	Karma: 46
E	EX	(20)	
R	TY	(6)	Resources:GD(10)
I	EX	(20)	
P	EX	(20)	Popularity: 10

### KNOWN POWERS:

*Humanoid Race:* Like Namor and Namora, she is a hybrid of human and Atlantean descent.

*Water Freedom:* Namorita is perfectly adapted for life in any depth of the sea. She has Excellent Resistance to cold.

*True Invulnerability:* Namorita enjoys Good protection against physical attacks.

*Water-Breathing:* As an Atlantean-human hybrid, she is amphibious and can breathe either water or air indefinitely.

*Hyper-Swimming:* Namorita can attain Poor waterspeed (30 mph) for a period of several hours.

*Winged Flight:* Like her uncle Namor, the combination of human and Atlantean genes produced the strange side effect of giving her ankle-wings and the ability to fly. She can attain Poor airspeed (35 mph). While in flight she can carry a load of 300 pounds.

*Electrical Generation:* Although she has never displayed this power, there is no reason she should not share it with her uncle. With it, she can generate electricity enough to cause Remarkable damage to targets up to one area away.



**TALENTS:** Namorita has a natural familiarity with Oceanography.

**CONTACTS:** She is Namor's niece. She is currently a follower of Aquarian.

**BACKGROUND:** Namorita is the daughter of Namora and Talan. Since Namora was the daughter of a human mother and Atlantean father, she possessed hybrid characteristics that passed on to her daughter. These included blond hair, pink skin, and certain powers. When Namorita was three, Talan was killed by the suboceanic nuclear tests that destroyed the city of Maritanis. Namora and other Atlanteans fled to the Pacific realm of the Lemurians. Namora attracted the attention of the local ruler, Prince Marro, and the jealousy of Merro's would-be fiancée, Llyra. Namora and Merro soon met mysterious deaths. Llyra spared the young Namorita. Llyra and Byrrah later used Namorita as a pawn in a bid to conquer Atlantis. Namor defeated the plot and freed Namorita.

Namor sent Namorita to the surface world for her education. He entrusted her to the care of his former girlfriend, Betty Dean Prentiss. Namorita attended high school during this period. However, her plans to enter college were interrupted when Lemuel Dorcas murdered Prentiss. At present, Namorita is one of Aquarian's followers.

**RUNNING NAMORITA:** Namorita is trying to be a typical American teenager despite her eccentric background and powers.

## ATTUMA

F	IN	(40)	Health: 175
A	GD	(10)	
S	MN	(75)	Karma: 32
E	AM	(50)	
R	TY	(6)	Resources: EX(20)
I	TY	(6)	
P	EX	(20)	Popularity: -10

### KNOWN POWERS:

*Humanoid Race:* Attuma is a member of the Homo Mermanus race.

*Water Freedom:* Attuma is perfectly adapted for aquatic life and can survive in any section of the ocean.

*True Invulnerability:* Attuma's skin is inured to the pressures of the deepest ocean. He has Excellent armor against physical attacks.

*Water-Breathing:* Attuma breathes water instead of air.

*Hyper-Swimming:* Attuma can attain Good velocities underwater (60 mph).

**WEAKNESS:** Finite Limit: As a water-breather, Attuma suffers damage after extended periods away from the water. After 10 minutes, he begins to "drown." On the surface, his Strength drops to Incredible and his Health drops to 140.

**TALENTS:** As a warrior, Attuma is skilled in Martial Arts C and E. He is a Specialist in the use of his chosen weapons, a triple-bladed sword and a war hammer. He is an expert in the cartography of the ocean floor.

**WEAPONS:** Attuma's sword is capable of doing Amazing damage against living targets. His war hammer can do Incredible damage against anything. Both weapons have Amazing Material Strength.

**CONTACTS:** Attuma is the chief of a barbarian Skarka tribe. He is a former ally of the Red Ghost and the renegade Atlanteans Krang, Byrrah, and Ikthou.

**BACKGROUND:** Attuma was born into a nomadic tribe of Atlantean derivation. When he came of age, he learned of a prophecy of a conqueror who would take Atlantis by force. Attuma decided he was that conqueror and immediately set off to fulfill the prophecy. Attuma and his tribe nearly conquered Atlantis but were defeated when Lady Dorma summoned the FF. Attuma has attacked Atlantis several times since then, only to be defeated at each turn. He has sought various allies to assist his conquests. In an attempt to breed a son who could defeat Namor, Attuma kidnapped what he thought was Jean Grey; unfortunately he kidnapped Phoenix instead. Attuma's sole victory over Namor was his part in the death of Lady Dorma.

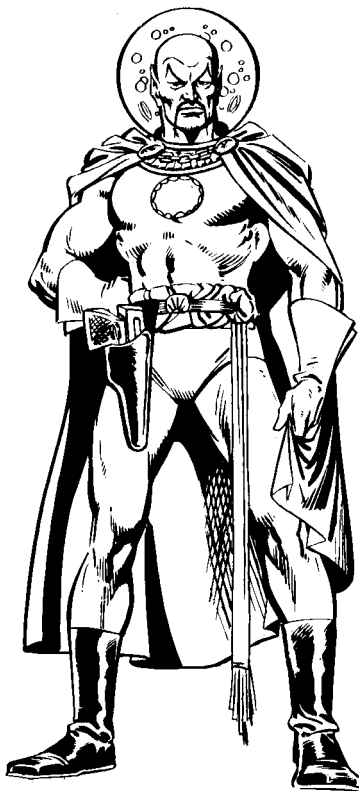

**RUNNING ATTUMA:** Attuma is a ruthless, battle-hungry conqueror. People are either his tools, conquests, or foes.

## WARLORD KRANG

F	IN	(40)	Health: 130
A	EX	(20)	
S	IN	(40)	Karma: 40
E	RM	(30)	
R	EX	(20)	Resources: EX(20)
I	GD	(10)	
P	GD	(10)	Popularity: -5

### KNOWN POWERS:

*Humanoid Race:* Krang is member of Homo Mermanus.

*Hyper-Swimming:* Krang can attain Poor water-speed (30 mph).

*Water Freedom:* Krang is perfectly adapted for aquatic life in any section of the ocean.

*Water-Breathing:* Krang requires a supply of sea water.

**WEAKNESS:** Finite Limit: As a water-breather, Krang suffers if he is away from water or his amphibian serum. After ten minutes, his gills dry up and he begins to "drown." On land, his Strength drops to Excellent and his Health decreases to 110; if he uses his amphibian serum, the losses do not occur.

### EQUIPMENT:

*AMPHIBIAN SERUM:* This Atlantean chemical transforms a blue-skinned, water-breathing Atlantean into a pink-skinned air-breather. The serum's effects last for one day.

*BODY ARMOR:* Krang wears a chainmail bodysuit that gives him Remarkable protection from physical and energy attacks. The suit is topped by a clear helmet with a internal water-purification system.

*PISTOL:* Krang carries a modified Atlantean energy pistol. The weapon emits a plasma beam with Remarkable intensity and a range of 7 areas.

**TALENTS:** Krang is an expert in military tactics, especially those involving aquatic warfare. He is an expert on Atlantean equipment.

**CONTACTS:** In his early days, Krang was warlord of the Atlantean forces and Namor's right-hand man; those ties are permanently lost. Krang has been allied with such renegade Atlanteans and supervillains as Attuma, Byrrah, Dr. Dorcas, and the Puppet Master. He was a member of the original Serpent Squad.

**BACKGROUND:** Krang arose to prominence during the period of the Atlanteans' wandering across the sea floor. By the time Namor led the exiles back to Atlantis, Krang was the supreme military commander. With Namor's return, Krang lost both his bid to gain the Atlantean throne and his fiancée, Lady Dorma. Krang began a series of covert, then open actions against Namor. Krang eventually fled Atlantis and became a supervillain. He later gained vengeance on Namor and Dorma when he contributed to her death.

**RUNNING WARLORD KRANG:** Krang is a cunning strategist. He prefers to ally himself with others powerful enough yet subservient enough to accomplish his goals. He has a monomaniacal hatred of Namor. To this end he will seek out and try to destroy anything Namor holds dear. Krang is aware of Namor's affection for Sue and may attempt to harm her as a way of striking at Namor.



# FIENDS AND FOES

## DOCTOR DOOM

Victor von Doom

F	RM	(30)	Health: 120
A	EX	(20)	
S	RM	(30)	Karma: 140
E	IN	(40)	
R	AM	(50)	Resources: AM(50)
I	IN	(40)	
P	AM	(50)	Popularity: 40

### KNOWN POWERS:

*Hyper-Invention:* He has Monstrous Reason when it comes to devising or building new devices.

*Mind Transferral:* The Ovoids taught Doom the Monstrous ability to transfer his mind to another body. He can either dominate the victim's mind or transfer that mind into Doom's own body.

*Ritual Magic:* Doom has a variety of spells he learned from his mother's notes. These spells all have Typical rank:

- *Mystic Bolt*—He can conjure bolts of Amazing intensity.
- *Dimension Travel*—He can make the journey to Mephisto's realm and back.
- *Summoning*—Doom has the Good ability to Summon supernatural beings. This power is rarely used except when he is practicing the magic learned from his mother's notes.
- *Sympathetic Magic*—Doom has the Feeble ability to use voodoo-like techniques to control people. Because this ability is so weak it is almost never used.

*Cyborg (Exoskeleton):* Most of Doom's powers are derived from equipment in his grey armor. Although he could voluntarily leave the armor at any time, he never does so.

This is a suit of steel armor enhanced with various devices of Doom's design. The armor has Incredible Material Strength and gives Doom Incredible protection from physical and energy attacks. Internal computers and motors increase Doom's physical abilities; without his Armor, Doom's physical abilities drop to Excellent, his Health failing to 80 if it is not already below that.

*Force Field:* The armor generates a Monstrous field against physical and energy attacks.

*Kinetic Bolt:* The gauntlets and face plate can fire bolts of Amazing Intensity and Remarkable range.

*Electricity:* As a defensive action, the armor can release a blast of Unearthly intensity. This does power rank damage

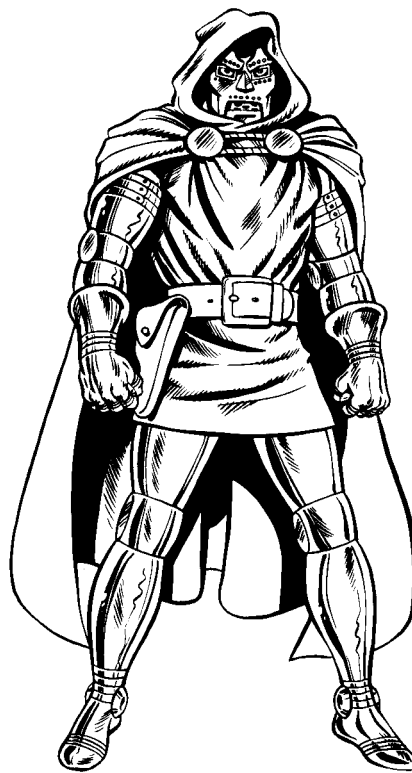

against anyone in contact with Doom and Incredible damage against anyone within 10 feet (the same area) of him.

*Rocket:* Twin jets on the armor's waist give him Excellent airspeed.

*Self-Sustenance:* The armor can provide him with air, food, and water for a period of several weeks.

**TALENTS:** Doom is a dangerous combination of scientific genius and budding sorcerer. His inventions rival and possibly exceed those of Reed Richards. He has invented time machines, self-aware robots, mind-control devices, and more types of super-weapons than anyone else on the planet. As leader of Latveria, he has political skills.

**CONTACTS:** He is an occasional ally of the Sub-Mariner, but the only beings Doom can actually count on are his staff of robots at Castle Doom.

**BACKGROUND:** Victor Von Doom was the child of gypsies living in the Balkan country of Latveria. His father Werner was a local healer and his mother Cynthia was a sorceress. She died when Mephisto seized her soul and took it to his realm. Werner died when he was

killed by the King's troops for failing to cure the dying queen. Afterwards, Victor was raised by another gypsy family and fell in love with their daughter Valeria.

Victor had an incredible thirst for new knowledge. First he explored magic through the books left him by his mother. Then he traveled to the U.S. in search of scientific knowledge. There he met Reed Richards when they were students in Empire State University's Physics department. Doom tried to combine his magical and scientific talents into a device that would enable him to communicate with the dead. When he first used the device, it exploded and gave him a small scar along his jaw. Doom was convinced he was hideously maimed and left the U.S.

He continued his quest for knowledge in Tibet. He joined an order of monks to learn their skills and knowledge. They helped him build his first armor. Doom insisted on donning the mask while it was still red-hot, thus further scarring his face.

Doom returned to Latveria and overthrew its monarch, King Rudolpho. He established a scientific citadel where he worked on weapons for world conquest. When the FF came into existence, Doom recognized Reed and felt the urge to destroy this rival. This began the long running war that has plagued the FF ever since.

Doom has been seemingly killed on various occasions. The most recent time was when his body was vaporized by Terrax. In this case, he transferred his mind into the body of a hapless bystander. The Beyonder later recreated Doom's original body and returned him to it. Unfortunately, prior programming caused his robots to transform Doom's chosen heir, Kristoff, into another "Dr. Doom." Both Drs. Doom are currently trying to destroy "the imposter."

**RUNNING DR. DOOM:** At the core of Doom's mind is a strong Oedipal Complex. He wants to rescue his mother from Mephisto. To this end he has learned every magical or technological trick that could help him in his quest. Doom is also an incredible egotist. He believes he is the greatest, smartest man in the world or perhaps even in the galaxy. When someone comes along who challenges that belief (such as Reed), Doom swears a vendetta against that rival.

As a peculiar side-effect of his ego, Doom possesses a much-vaunted sense

of honor. He considers it demeaning to break a promise once he has made it. However, Doom will happily lie to potential allies and turn on them when the time is ripe, should he not consider them his peers.

## DOOMSMAN

F	RM	(30)	Health: 120
A	EX	(20)	
S	RM	(30)	Karma: 32
E	IN	(40)	
R	EX	(20)	Resources: AM(50)
I	TY	(6)	
P	TY	(6)	Popularity: 40

### KNOWN POWERS:

**Robotic Body:** The Doomsmen are robotic replicas of Doom when he's wearing his armor. They are programmed to imitate Doctor Doom when he is not present, and are sophisticated enough to fool even psionic scans.

The Doomsmen have all of the powers possessed by Doom's Armor.

**TALENTS:** The Doomsmen are programmed to simulate Doom's scientific talents. They possess none of his magical skills.

**CONTACTS:** The other Doomsmen robots.

**BACKGROUND:** The Doomsmen were created to serve as agents and decoys for Dr. Doom. They are his most dependable robots and are entrusted with his most valuable programs. The most important task they have is maintaining Dr. Doom's existence. If he is imprisoned, the robots will rescue him. If he is seemingly killed, they will try anything to find or revive him. Finally, if he is irrevocably dead, the Doomsmen will recreate his mind in a new body. This they recently did to young Kristoff, with the result that the boy now thinks he is Dr. Doom. The Doomsmen are currently debating the idea that the real Dr. Doom is alive.

**RUNNING A DOOMSMAN:** The Doomsmen are programmed to act as if they were Dr. Doom. They only admit their robotic status when they are in the presence of Dr. Doom or other Doomsmen.

## GUARDIAN ROBOTS

F	GD	(10)	Health: 80
A	GD	(10)	
S	RM	(30)	Karma: 10
E	RM	(30)	
R	TY	(6)	
I	FE	(2)	
P	FE	(2)	

**KNOWN POWERS:** *Robotic Body:* The Guardsmen are humanshape robots intended to function as police and soldiers.

*Body Armor:* They have Remarkable Material Strength armor against all physical and energy attacks.

**BLASTER PISTOL:** *Plasma Generation:* Excellent intensity blast with side-effects of Good intensity Heat and Neural Disruption.

**BACKGROUND:** The Guardian Robots were built by Doom as a police and defense force for Latveria. Their outer shell is designed to resemble the battle armor worn by Doom's human troops. However, their faces are distinctly robotic. Although these robots are self-aware, they are controlled from Castle Doom. Consequently, whoever holds the castle can reprogram the Guardians to serve him.

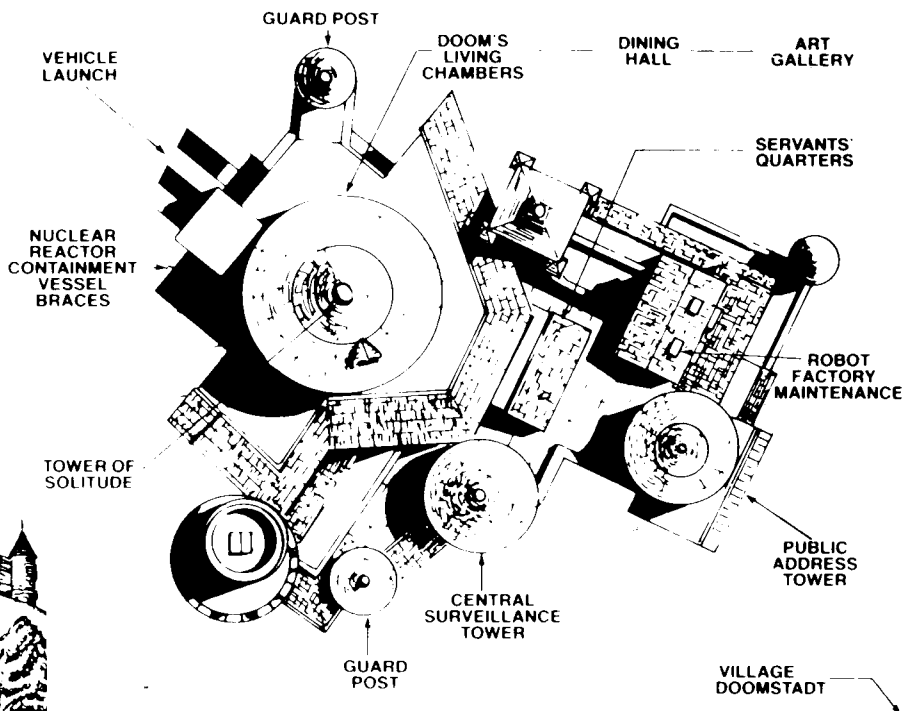
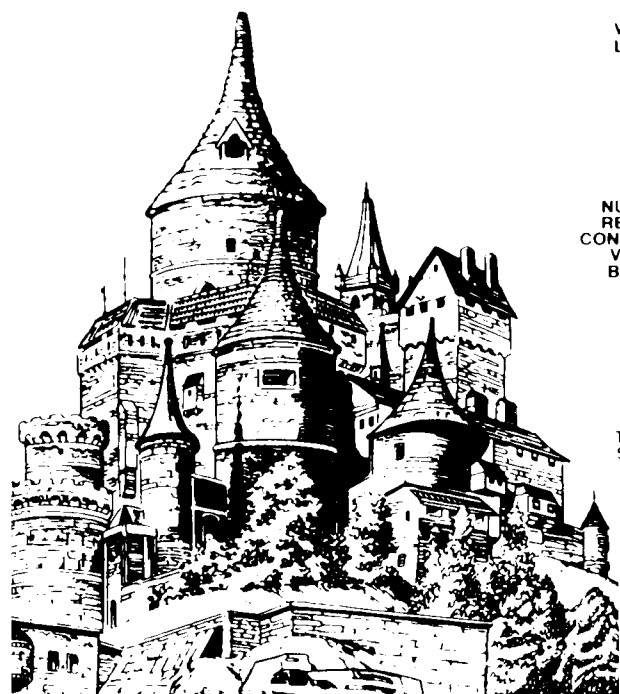

**RUNNING A GUARDIAN:** The Guardians follow orders blindly and explicitly. They are normally found only around Doomstadt.

## GUARDBOTS

F	GD	(10)	Health: 70
A	EX	(20)	
S	GD	(10)	Karma: 6
E	RM	(30)	
R	FE	(2)	
I	FE	(2)	
P	FE	(2)	

### KNOWN POWERS:

*Body Armor:* Their outer shells have Excellent Material strength.

*Plasma Generation:* Each Guardbot is equipped with an internally-mounted Ionic Laser which does Remarkable damage. This is mounted in the Guardbot's "face." Consequently, the robot must face its target (in game terms, must roll a successful Intuition FEAT against a target's Agility) to use this power.

*Hyper-Running:* The Guardbots are equipped with a tricycle pedestal that gives them Remarkable landspeed (90 mph).

*Explosive:* The Guardbots are equipped with a self-destruct device that demolishes the Guardbot and does Remarkable damage to anything with 20 feet (2 areas) of it.

**BACKGROUND:** The Guardbot series are usuforn robots designed to assist the Guardian series in defending against invaders. Their tricycle base enables them to rapidly cover large areas (Remarkable landspeed, 90 mph). Because of their harshly mechanical appearance, they are assigned to areas away from normal human habitation. However, a strike force of ten is kept in Doomstadt to handle superpowered invaders.

**RUNNING A GUARDBOT:** The Guardbots are mindless automatons with limited programming. They are directly controlled from the castle. They are programmed to concentrate their attacks on whoever tries to directly interfere with their programming or functioning. If they are being disabled they are programmed to self-destruct.

## KILLER ROBOTS

F	EX	(20)	Health: 165
A	EX	(20)	
S	AM	(50)	Karma: 6
E	MN	(75)	
R	FE	(2)	
I	FE	(2)	
P	FE	(2)	

### KNOWN POWERS:

*Body Armor:* Their outer shells have Amazing Material strength.

**BACKGROUND:** The Killer Robot series was built for one purpose, to destroy everything in their path. Doom intended them to be a Doomsday weapon not to be used unless he was no longer in control of Latveria. Unlike the Guardian Robots, they cannot be controlled and reprogrammed from Castle Doom.

**RUNNING A KILLER ROBOT:** They are relentless, mindless killing machines. Once activated, they cannot be stopped except through their total annihilation.

## VICTOR VON DOOM II

F	GD	(10)	Health:36
A	TY	(6)	
S	GD	(10)	Karma: 140
E	GD	(10)	
R	AM	(50)	Resources: AM(50)
I	IN	(40)	
P	AM	(50)	Popularity: 5

### KNOWN POWERS:

Although Victor II originally was a relatively normal human, an experiment by Doom later gave him powers equal to the FF's.

*Hyper-Strength:* Amazing rank. His Health likewise rises to 76.

*Armor Skin:* Orange, rocky plates similar to the Thing's gives him Remarkable protection against physical and energy attacks.

*Elongation:* Monstrous rank with a maximum bodylength of 100 ft.

*Fire Generation:* Amazing rank.

*Force Field:* Amazing rank.

*Invisibility (Physics-type):* Excellent ability to be invisible to light or radar-based senses.

*True Flight:* Good airspeed (120 mph).

**TALENTS:** Victor II had a basic knowledge of all of Dr. Doom's talents and skills.



**CONTACTS:** Victor II is Dr. Doom's clone. He was also head of Cynthan Associates, a scientific organization secretly organized by Dr. Doom.

**BACKGROUND:** A few years ago Dr. Doom decided that Latveria needed a leader whom the rest of the world would find acceptable. However, he still wanted to retain actual control of Latveria. He decided to create a clone of himself and pass it off as his "son." The plan would then call for Dr. Doom to abdicate in favor of his heir. A secondary plan called for Dr. Doom to capture the FF and transfer their powers into Victor II.

At the time Reed was suffering from the loss of his powers. Because a powerless Reed was useless to Dr. Doom's plan, he had Cynthan Associates help Reed recreate his powers. Then, when Reed attacked Doomstadt to free the rest of the FF, Dr. Doom captured him and added him to the experiment.

The power transference worked. Victor II gained powers equal to the FF's. Unfortunately, this included a version of the Thing's rocky hide. Both Dooms' vanities were appalled at the result. Victor II also gained the FF's honor and basic goodness. Sickened by the realization of Dr.



Doom's evil, Victor II attacked Dr. Doom. In the battle that followed, Victor II almost destroyed the real Doom. In a desperate move, Doom blasted Victor II with all his electrical power. Victor II died.

**RUNNING VICTOR II:** Victor II is the genetic and mental equivalent of Dr. Doom during his college days (before the face- and mind-scarring accident).

## DOCTOR DOOM II

Kristoff

F	RM	(30)	Health: 120
A	EX	(20)	
S	RM	(30)	Karma: 140
E	IN	(40)	
R	AM	(50)	Resources: AM(50)
I	IN	(40)	
P	AM	(50)	Popularity: 40

### KNOWN POWERS:

*Hyper-Invention:* He has Monstrous Reason when it comes to devising or building new devices.

*Body Armor (Tech):* Most of Doom's powers are derived from equipment in his grey armor.

This is a suit of steel armor enhanced with various devices of Doom's design. The Armor is modified to fit Kristoff's child-sized body; when he wears it he appears to be an adult. The armor gives him Incredible protection from physical and energy attacks. It possesses Incredible Material Strength. Internal computers and motors increase Kristoff's physical abilities; without his Armor, Kristoff's physical abilities drop to Poor, and his Health falls to 16. *Force Field:* The armor generates a Monstrous field against physical and energy attacks.

*Kinetic Bolt:* The gauntlets and face plate can fire bolts of Amazing Intensity and Remarkable range.

*Rocket:* Twin jets on the armor's waist give him Excellent airspeed.

*Self-Sustenance:* The armor can provide him with air, food, and water for a period of several weeks.

**TALENTS:** As "Doom", Kristoff has the full range of Doom's scientific genius.

**CONTACTS:** None.

**BACKGROUND:** Kristoff was a normal Latverian boy living in Doomstadt when

Doom regained the throne from Zorba. During the fighting, his mother greeted the newly returned Doom and asked his protection. Seconds later she was killed by Doom's Guardian robots. Doom decided to protect her son Kristoff. Later, he decided to make Kristoff part of his contingency plan should he ever be killed. When the Doomsmen received the information that Dr. Doom had apparently been killed by Terrax, the plan went into effect. The robots took Kristoff to Doom's lab and began to duplicate Doom's memories in Kristoff's mind. The process overwhelmed Kristoff's own mind; that personality has ceased to exist. Kristoff/Doom only allowed the Memory Duplication to carry him through Doom's first two battles with the FF, including the time when Doom lifted the entire Baxter Building into orbit.

Because Kristoff/Doom ordered the memory tapes to halt at that point, he has no further memories of Doom's career. He immediately struck at the FF by again lifting the Baxter Building into orbit and actually blowing it up. The FF escaped and confronted "Doom" in his castle. Kristoff was exposed and taken to NYC. Later, his Doomsmen rescued him and he had his first confrontation with the real Dr. Doom. The battle continues.

**RUNNING DR. DOOM II:** Because Kristoff ordered the tapes shut off before they completed their run, his personality and memory are that of a Dr. Doom at the start of his super-villainous career. He believes he is Dr. Doom; his appearance is irrelevant. He "knows" the real Dr. Doom is an impostor who must be destroyed.

## ZORBA

Prince Zorba of Latveria

F	IN	(40)	Health: 70
A	GD	(10)	
S	GD	(10)	Karma: 60
E	GD	(10)	
R	EX	(20)	Resources: EX(20)
I	EX	(20)	
P	EX	(20)	Popularity: 20

### KNOWN POWERS:

*Cyborg/Extra Parts:* a Nega-Beam blaster is housed in a prosthetic right eye. *Nega-Beam:* This ray does Incredible damage.



**TALENTS:** Zorba is a trained politician and guerrilla fighter. He possesses Martial Arts B and E.

**CONTACTS:** King Rudolpho of Latveria is his brother. Later the FF helped him depose Doom and claim the throne.

**BACKGROUND:** Zorba was the younger brother of King Rudolpho, the hereditary monarch of Latveria. When Doom overthrew Rudolpho, Zorba began to form an underground rebellion. With the help of the FF, he finally succeeded in restoring his royal line. Unfortunately, the ruthless methods he chose to adopt while leading the rebellion remained too strongly ingrained. Rather than a benevolent ruler, Zorba became a despot even worse than Doom. Doom returned to Latveria with an initially uncooperative FF in tow and ended both Zorba's reign and his life.

**RUNNING ZORBA:** Zorba began life as a noble, and believed strongly in both the class system and in the obligations of the upper class to lead (and rule) the lower class. During Doom's first reign, Zorba became a heroic avenger out to correct the perceived evils of Doom's reign. Once Zorba finally held the throne, he became a tyrant.



## GALACTUS

Galan of Taa

F	MN (75)	Health: 4150
A	MN (75)	
S	CL1000	Karma: 3000
E	CL3000	
R	CL1000	Resources: CL3000
I	CL1000	
P	CL1000	Popularity: - 1000

### KNOWN POWERS:

Galactus possesses the following powers, each at CL3000 Intensity. However, each use of these powers costs Galactus 10 points of Karma, and each use at an intensity above Unearthly also costs him 50 points of Health.

*Spirit Vampirism:*

*Bio-Vampirism:*

*Psionic Vampirism:*

*Energy Vampirism:*

*Absorption Power:*

*Energy Conversion:*

*Elemental Conversion:*

*Molecular Conversion:*

*Elemental Creation:*

*Molecular Creation:*

*True Flight:* Galactus can travel at CL3000 speed (lightspeed).

*True Invulnerability:* Galactus has Shift X resistance to physical and energy attacks. He has CL5000 resistance to extreme heat and cold, corrosives, toxins, and disease.

*Force Field:* Galactus can surround himself with protective fields of Shift X rank.

*Life Detection:* Galactus has the CL3000 ability to detect the life energies of planets. He can detect an occupied planet at a maximum range of 50 light years.

*Kinetic Bolts:* Galactus can release energy blasts of Shift-Z Intensity.

*Hyper-Invention:* Galactus can create any device he wants by assembling whatever materials are either in hand or can be made from existing substances.

*Disruption:* As a side effect of his feeding process, Galactus has the CL1000 ability to destroy the molecular bonds that hold the target together. Galactus can consciously use this power with diminished effect against lesser targets, such as individuals. In such a case the power decreases to Shift-X rank.

*Power Creation:* Galactus has the CL1000 ability to transform ordinary beings into super-beings. The Primary Abilities and powers of such beings are initially no higher than Unearthly rank. Galactus can invest the power in either

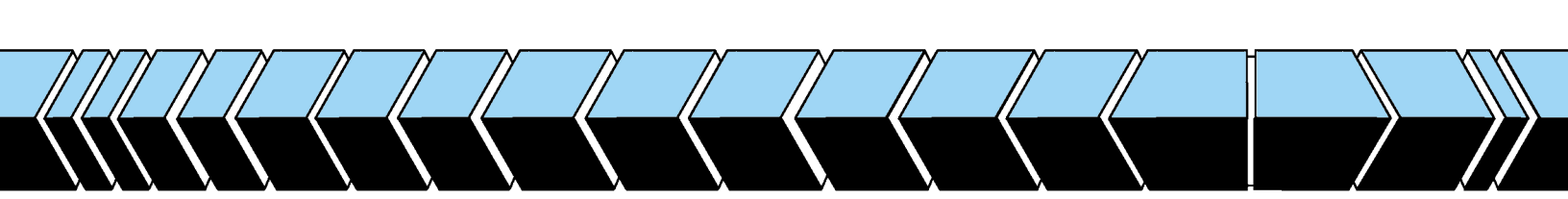

the person chosen or a specially designed tool.

**Power Control (Magnification/Reduction/Negation):** Galactus has total control over those powers he may have given a target. He can amplify someone's existing powers by 4 CS, even if he was not the source of that power. He can reduce a subject's powers any amount, all the way to Shift 0. Such changes are permanent; only Galactus can reverse his changes.

**Serial Immortality:** If Galactus' body should be destroyed while he still has a sufficient cosmic energy reserve, his machines can draw in his lifeforce and recreate his body. He must have at least two points of Health for this to occur.

**Telepathy:** Galactus has Unearthly Telepathy.

**Cosmic Awareness:** Galactus has CL1000 Cosmic Awareness and can perceive in a limited manner the state of the universe.

**WEAKNESS:** Galactus has a finite energy supply that he must constantly replenish by consuming the lifeforce of entire worlds. Galactus' hunger is so severe that he must feed every 30 Terran days or his abilities drop. If he has not consumed a world after that period, all his CL3000 abilities drop to CL1000. After another 30 days, all his abilities drop to Shift-Z, and so on. Although Galactus could eventually starve to death, he normally seeks out the nearest usable world when his abilities drop to Shift-X rank.

**CONTACTS:** Galactus has one Contact, his Herald, and even that relationship is tenuous at best. He considers himself to be siblings with Death and Eternity, as they were all created by the Big Bang.

**BACKGROUND:** Galactus is the sole survivor of the universe that existed before the Marvel Universe was created. Originally Galactus was a humanoid named Galan, a native of the planet Taa. Unfortunately, Galan's universe was in a state of collapse as it ended its lifecycle. The universe was regathering itself into a "Cosmic Egg," an unimaginably dense sphere that would contain all the matter in the universe. The radiation that accompanied the collapse was destroying all life in the universe. The people of Taa sent Galan out in the hope that he could find some way for them to escape. There was none. When Galan returned, he

discovered all but a handful of Taa's population had been killed. Galan and the survivors decided to end it all by journeying directly to the heart of the Cosmic Egg. The radiation killed everyone but Galan, who found himself invigorated by the deadly forces.

The Cosmic Egg was alive and prevented Galan's ship from being destroyed. It explained that, even though both of them were dying, they would soon be reborn. The Cosmic Egg would explode in a great explosion and create a new universe.

When the predicted "big bang" occurred, three beings, a starship, and the Marvel Universe were created. The three were Eternity (the embodiment of the lifeforce of this universe), Death, and Galactus. The ship was the recreation of Galan's starship.

For eons Galactus drifted in the void, further evolving and developing his powers. A Watcher who discovered him contemplated killing him then, but the Watcher decided to abide by his race's creed of passive observance. Eventually his ship drifted into the Archeopian star system and Galactus fed for the first time. In the millennia that followed, Galactus rebuilt the remains of Archeopia's worlds into an immense starbase, the worldship Taa II.

Originally several centuries passed between feedings. This interval shortened with time. It is currently one month. This has led Galactus to increase the rate at which he destroyed worlds. He realized years ago that he needed scouts to seek out the worlds that could sustain him. When Galactus approached the planet Zenn-La, he found his first Herald in the form of Norrin Radd, the Silver Surfer. The Silver Surfer eventually led Galactus to Earth, where he finally met his match. Thanks to the assistance of the Watcher Uatu, the FF acquired the Ultimate Nullifier, the only weapon that could destroy Galactus. Galactus returned to space, unfed and Herald-less.

Galactus went through a rapid succession of Heralds over the next decade. The Xandarian Gabriel Lan was transformed into the Air-Walker. Unfortunately he was soon killed defending Galactus against the Ovoids. Galactus created a robotic replica, the Air-Walker Automaton. That was damaged by the Silver Surfer and completely destroyed by Thor. A friend of Gabriel Lan, Pyreus Krii, became the next Herald, Firelord. He

gained his freedom when Thor traded Galactus the Destroyer, a robot constructed by Odin. Loki stole it before Galactus could get much use out of it. Seeing that the FF had been the cause of the loss of his first Herald, Galactus arranged for the FF to recruit his next one. This was Tyros of Lanlak, a conqueror and tyrant himself, whom Galactus transformed into Terrax the Tamer. Terrax became intoxicated by his new power and tried to use the FF to destroy Galactus. Instead, Galactus destroyed him. Finally, Frankie Raye offered herself to Galactus. As Nova, she is his first female herald. There is some suspicion that Nova is actually failing in love with Galactus.

Galactus has tried several times to devour the Earth but was beaten, lured, or otherwise bribed away. On his last trip, he finally pledged never to attack the Earth so long as the Human race survived. This pledge is unique in the universe and the cause of some hostility towards the Earth by other races who have fought or been decimated by Galactus.

**RUNNING GALACTUS:** Galactus is a completely amoral individual who does what he wants to do without any consideration of the consequences on other beings. His favorite self-explanation is "I am beyond good or evil ... I simply am." The survivors of the millions of worlds he has destroyed think otherwise. Galactus had been told that his existence had a higher purpose; perhaps he hopes that this unknown destiny will somehow compensate for all the destruction he has wrought.

Galactus has one pride, his honor. If he makes a promise, he will hold to it until the universe ceases to exist. There is one exception, though. When Galactus is starving, he will do anything to feed. He will even break previously sworn oaths, such as his pledge to no longer threaten Earth.

## GALACTUS' SHIPS

**WORLDSHIP:** Galactus' transport is a mile-wide sphere. It is most likely that a person will encounter him in this ship. The Worldship possessed the essential portions of Galactus' support machinery. It possesses a stardrive that can propel the ship at CL5000 speeds and journey



through hyper-space to reach a destination almost instantaneously. The Worldship contains the apparatus that enables Galactus to destroy a living world and convert it into consumable energy. However, the device requires 6 hours to assemble and ready itself for operation. To make sure Galactus is undisturbed, the Worldship can project a Force Field of CL5000 intensity. Its walls have a CL1000 Material Strength. There is no actual control room; rather, the Worldship follows Galactus' mental commands. If Galactus is separated from the Worldship, it can follow his orders even at a distance of several light years. Should Galactus fall into death-like state, the Worldship is programmed to seek him out, recover the body, and transport it to Taa II.

**TAA II:** When Galactus destroyed the Archeopian race, he was left with possession of their star system. Galactus dismantled the planets and used the materials to create an immense headquarters for himself. The helix-shaped structure encircles the star. The interior can only be guessed at. It contains the entire array of Galactus' devices. There is a dock for his Worldship. Galactus maintains a museum with mementos of the worlds and races he has destroyed. It includes a bestiary with some really gigantic animals. Taa II also housed the Ultimate Nullifier, until Uatu the Watcher helped the Human Torch steal it when Galactus first threatened Earth.

Taa II was recently destroyed during a battle. However, Galactus has ample time to rebuild the starbase.

## GALACTUS' CAT

F	MN	(75)	Health: 250
A	AM	(50)	
S	MN	(75)	Karma: 16
E	AM	(50)	
R	PR	(4)	Resources: N/A
I	TY	(6)	
P	TY	(6)	Popularity: N/A

### KNOWN POWERS:

*Robot Body:* The "Cat" is a 20 foot tall robot. It is strictly a mindless automaton lacking self-awareness.

*Body Armor:* The Cat's outer shell has Monstrous material strength. However, the eyes and mouth are only Typical material strength.

*Paralyzing Spray:* The Cat can belch yellow paralyzing foam from its mouth. The range of the spray is two areas; accuracy is determined by the Cat's Monstrous Fighting rank. The foam possesses Uearthly Paralysis. Targets must make an Endurance FEAT to avoid being paralyzed for 1 -10 turns. Those making the FEAT are only paralyzed for a single turn. The foam can penetrate cloth and most natural armor skins. It cannot penetrate force fields opposing physical attacks, sealed inorganic armor such as a space suit or Iron Man's armor, or armor skins or Invulnerabilities of greater than Uearthly rank.

**TALENTS:** None.

**CONTACTS:** None.

**BACKGROUND:** The Cat is a 20' foot tall robot designed to patrol Taa II and capture any intruders or vermin.

**RUNNING THE CAT:** The Cat is a mindless automaton directly controlled by Galactus' computer systems. It has no self-awareness. It follows its orders literally.

## PUNISHER I

F	MN	(75)	Health: 450
A	MN	(75)	
S	X	(150)	Karma: 6
E	X	(150)	
R	FE	(2)	Resources: none
I	FE	(2)	
P	FE	(2)	Popularity: -20

### KNOWN POWERS:

*Robot Body:* The Punisher is a robot created by Galactus.

*Body Armor:* The Punisher's armor plating has Monstrous Material Strength.

*Plasma Generation:* The Punisher can emit blasts of Monstrous Intensity.

**TALENTS:** None.

**CONTACTS:** None.

**BACKGROUND:** Punisher is a robot built by Galactus. Its original purpose is unknown; it may have been intended to act as a custodian for Galactus' bestiary. When Galactus created the Silver Surfer, he modified the Punisher's programming so that the robot would seek out the

Herald if he ever became rebellious. When the Silver Surfer turned against Galactus, the Punisher was teleported to Earth to defeat him and return him to the Worldship. Although the Punisher could have defeated the Surfer, it was unable to defeat the Surfer AND the FF. It was destroyed. A second Punisher was sent to force the Silver Surfer to reclaim his job of Herald. It was recalled before the FF could destroy it. The Punisher now serves as an errand-runner for Galactus.

**RUNNING THE PUNISHER:** The Punisher has a single purpose—to carry out Galactus' will. It single-mindedly carries out its orders, even if it risks self-destruction.

## SILVER SURFER

Norrin Radd of Zenn-La

F	AM	(50)	Health: 325
A	MN	(75)	
S	UN	(100)	Karma: 135
E	UN	(100)	
R	EX	(20)	Resources: PR(4)
I	MN	(75)	
P	IN	(40)	Popularity: 17

### KNOWN POWERS:

*Power Conversion:* The Surfer has the power to channel cosmic radiation into his body and transform it into useful forms, including sustenance and energy for his other powers. He can channel the power directly into his Primary Abilities to either raise Agility to Uearthly or his Strength to Shift-X. He can use the power to self-heal up to Uearthly damage in a single turn.

*Body Coating:* His body is surrounded by a flexible metallic shell that gives him Monstrous resistance to physical attacks and Uearthly resistance to energy attacks.

*Self-Sustenance:* He does not need to breathe, eat, or drink anything to sustain his life.

*Life Detection:* He has the Uearthly ability to detect the presence of life energies within 500 light years.

*Plasma Generation:* The Surfer has the ability to emit blasts of Uearthly intensity from his hands. The maximum range is 60 areas.

*Telepathy:* He has Good telepathy. This is mostly used to communicate when normal conversation is impossible. It also allows him to rapidly learn a new language.

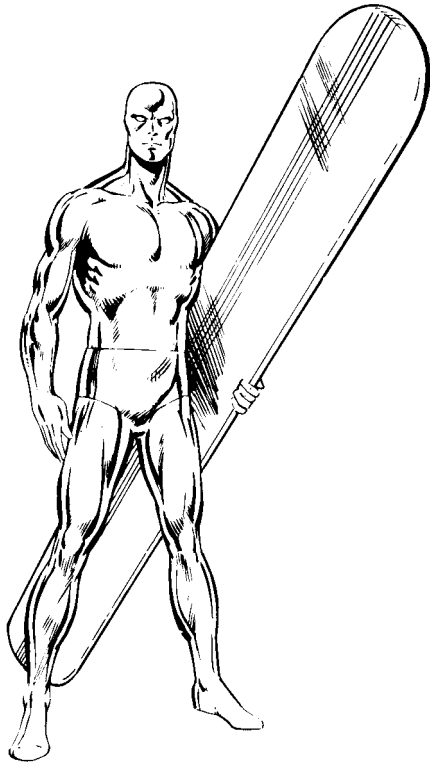

*Postcognition:* The Surfer has the Poor ability to see events that occurred up to four weeks ago. He must be at the site of the event in order for this power to work.

**THE SURFBOARD:**

The Silver Surfer's board is a construct of unknown material. It appears to be made from the same reflective material as the Surfer's body coating. The board is psionically linked to its owner and can automatically respond to his mental commands. It can travel independent of him and return to him if they are separated. When he rides it, the Surfer's feet automatically adhere to the board's upper surface. The board has the following powers:

*True Flight:* The board can attain CL5000 speed (10,000 mph in the atmosphere/ 1,000,000 mph in space).

*Dimension Travel:* Once its maximum speed is reached, the board can enter hyper-space to quickly reach any section of the universe.

*Phasing:* The board has the Monstrous ability to render itself and its rider(s) temporarily immaterial. This power is used to enable them to pass through a barrier or to travel through space without risking collision damage with spaceborne particles.

*Body Armor:* The board has CL3000 Material Strength.

**TALENTS:** Norrin Radd is a space pilot and possesses Astro-Navigational skills. He possesses Martial Arts D as well.

**CONTACTS:** Originally Norrin Radd had a tenuous contact on the Zenn-La Council of Scientists. After his conversion, his only lasting contact was with his master, Galactus. After he rebelled, he became a friend of the FF. After he was freed of the confines of Earth, he made contacts with both the new Zenn-La and the superhuman Mantis.

**BACKGROUND:** Norrin Radd is a native of Zenn-La, a peaceful, idyllic world free from all strife and woe. One day he discovered that Galactus' ship was approaching his world. He intercepted it in the hopes of persuading Galactus to leave Zenn-La in peace. Galactus explained that he had no time to seek a new world because his energies were too low. He then mused that if he had a herald to scout out worlds with the proper energies, he might be able to spare civilized worlds. Norrin leapt at the thought and offered his services as Galactus' first Herald. Galactus accepted and transformed Norrin Radd into the Silver Surfer.

Norrin performed his duties efficiently and was able to explore the universe as well as fulfill his duties. However, the trials of finding consumable but not-sentient worlds began to wear on him. To relieve his Herald's moral dilemma, Galactus erased from Norrin's mind all memories of his past on Zenn-La.

Norrin eventually located Earth, despite the Watcher's attempts to camouflage its existence. The Surfer summoned Galactus. When the FF battled the World-devourer, Norrin landed near Alicia Master's studio. She managed to convince the Surfer that humanity should be saved. He lent his power in the attack on Galactus.

Galactus released the Surfer from his servitude. However, he imprisoned the Surfer on Earth by erecting a barrier that specifically prevented the Surfer from leaving Earth's atmosphere.

In the following years, Norrin roamed Earth and studied its people. For a time his powers and board were stolen by Dr. Doom. Very recently the barrier was removed; the Surfer is free to roam space once more.

**RUNNING THE SILVER SURFER:** The Surfer is a quiet, meditative person who seeks the true order of the universe. He does not understand human conflicts but he will relentlessly fight against humanity's foes. Now free to wander space, Norrin finds himself the champion of whomever might need his aid, from the planet of Zenn-La to Galactus himself.

**AIR-WALKER**

**Gabriel Lan**

F	AM	(50)	Health: 275
A	MN	(75)	
S	AM	(50)	Karma: 155
E	UN	(100)	
R	RM	(30)	Resources: PR(4)
I	MN	(75)	
P	AM	(50)	Popularity: 0

**KNOWN POWERS:**

*Energy Conversion:* Airwalker has the Monstrous ability to absorb cosmic radiation and convert it into useful forms, including sustenance and power.

*Plasma Generation:* Airwalker can emit Monstrous Intensity blasts of energy. They have power rank damage and range. The blasts also have side-effects that Airwalker can tailor to his wishes. These include:

- Incredible intensity Light.
- Incredible intensity Heat and Flame.
- Incredible intensity Magnetism.
- Incredible intensity Electricity.
- Remarkable Geo-force.

*True Invulnerability:* Airwalker's body has Amazing resistance to physical and energy attacks; he can boost this to Monstrous rank for 1 -10 rounds once per day. He has CL1 000 resistance to extreme heat and cold.

*Self-Sustenance:* Airwalker can convert Cosmic radiation into life-sustaining energy, thus freeing him from the need to breathe, drink, or eat.

*Energy Sheath:* Airwalker's back emits a coherent energy field that resembles a fiery cape or red and yellow wings. The "cape" has Typical intensity and Amazing material strength. It acts as a reservoir for Air-Walker's cosmic power.

*True Flight:* Airwalker has CL1000 speed.

*Dimension Travel:* At full speed, he can enter hyper-space and instantly appear anywhere in the universe.

*Life Detection:* He has CL1000 range (5 light years).

*Telepathy:* Airwalker has Typical rank,



enabling him to read a mind up to 4 areas away. If he was contacting Galactus, his rank increases to CL5000.

**EQUIPMENT:** Gabriel possesses "The Horn of Galactus", a golden trumpet-like device that can summon Galactus across any distance.

**TALENTS:** Gabriel Lan is a starship captain and has the skills associated with such a position—Military, Astro-Navigation, and Starship Maintenance.

**CONTACTS:** As Gabriel Lan, he was a former member of the Nova Corps and captain of the Xandarian starship Way-Opener. As Air-Walker, he was the Herald of Galactus, although he retained his friendship with Pyreus Kril, later known as Firelord.

**BACKGROUND:** Gabriel Lan was a distinguished member of Xandar's Nova Corps and was later given captaincy of the explorer-scout Way-Opener. His mission was to discover and contact friendly races in Xandar's vicinity. On the return from his initial seven-year journey, he encountered Galactus' Worldship. Galactus teleported him on board and offered him the position of Herald. Lan accepted the power and the responsibility.

Air-Walker served Galactus faithfully for years. He even became Galactus' first friend. The relationship ended when Air-Walker intercepted an Ovoid fleet heading to destroy Galactus. Air-Walker

drove off the Ovoids at the cost of his life. Galactus' energies were at a low point and he would not spare the energy to revive his friend. Instead, he constructed a robotic simulation of Air-Walker's body and transferred Lan's memories into it.

**RUNNING AIR-WALKER:** Air-Walker was an avid explorer and valiant fighter. He was also Galactus' only friend, providing the Devourer of Worlds with a fresh wonder about the universe.

### AIR-WALKER AUTOMATON

F	UN	(100)	Health: 320
A	EX	(20)	
S	UN	(100)	Karma: 32
E	UN	(100)	
R	EX	(20)	Resources: FE(2)
I	GD	(10)	
P	FE	(2)	Popularity: 8

#### KNOWN POWERS:

*Robotic Body:* The Air-Walker Automaton was a mechanical recreation of the original Air-Walker, Gabriel Lan, and was programmed with his memory and personality.

*Self-Revival:* The Automaton had the Unearthly ability to completely reassemble and reactivate itself if its current Endurance is at least 35.

The Automaton's other powers were identical to the original's powers.

**TALENTS:** The Automaton had all of Lan's skills.

**CONTACTS:** The Automaton was Galactus' Herald. Since it resembled Lan, it initially had all his Contacts. When the Automaton first appeared on Earth, its name, manner, and appearance convinced humanity that it was the archangel Gabriel. Contacts based on these deceptions were lost when the Automaton's real nature was revealed.

**BACKGROUND:** The Air-Walker Automaton was constructed by Galactus as a means of reviving his friend and Herald. It didn't work; although the Automaton had Lan's memories and appearance, it lacked his soul. Galactus realized his error and dispatched the Automaton to Earth. It was supposed to persuade the Silver Surfer to rejoin Galactus. Instead, the Automaton was demolished after a



battle with the Surfer and the FF. Galactus abandoned the Automaton as a failed experiment,

**RUNNING THE AIR-WALKER AUTOMATON:** The Automaton had Lan's mind but lacks his personality. It felt the base emotion of anger and sought revenge against anyone who offended it.

### FIRELORD

Pyreus Kril of Xandar

F	MN	(75)	Health: 325
A	UN	(100)	
S	AM	(50)	Karma: 110
E	UN	(100)	
R	RM	(30)	Resources: N/A
I	AM	(50)	
P	RM	(30)	Popularity: 0

#### KNOWN POWERS:

*Energy Conversion:* Firelord possesses the Unearthly ability to draw in cosmic energy from his surroundings and transform it into useable forms. This may be for sustenance or to fuel his other powers. The visible manifestation of this power is the fiery aura emitted from his hair and eyes. Firelord can channel this energy into several Power Stunts that duplicate other powers; these function at Unearthly rank.

- Fire Generation
- Fire Control
- Gravity Control
- Heat



- Light Generation
- Light Control
- Plasma Generation
- Plasma Control
- Radio Generation
- Radiowave Control
- Sonic Generation
- Sonic Control
- Thermal Control

**Energy Sheath:** Firelord is surrounded by a fiery field that gives him Amazing protection from physical and energy attacks. This field is not actually combustion. It does not damage anything Firelord touches. However, as a Power Stunt, Firelord can temporarily increase the intensity of the field; this enables him to do Amazing damage to anything he touches.

**Self-Sustenance:** Firelord does not need to breathe, drink, or eat.

**Life Detection:** He has the Unearthly ability to detect the presence of life energies within 500 light years.

**Flight:** Firelord can attain CL1000 speed (Oust short of lightspeed). Once his maximum speed is reached, he can enter Hyperspace to instantaneously reach any other section of the universe.

**Immortality:** Due to Galactus' restructuring of Pyreus Kril's body, Firelord would have to be completely disintegrated before he could die.

**Staff:** This is a 5-foot rod of CL1000 material. Firelord uses it as a focal point for his powers. Although he can use his powers without the rod, he enjoys +1CS on all actions with it. Through unknown means it also assists his Astro-navigational skills.

**TALENTS:** As Pyreus Kril, he was First Officer of the Xandarian starship, Way-Opener. As such he possessed Military training and Astro-Navigational skills.

**CONTACTS:** As Pyreus, he has the Nova Corps and the Xandarian people as a Contact. As Firelord, his original Contact was Galactus. Since then he has become friends with Thor and Starfox.

**BACKGROUND:** Pyreus Kril was First Officer of the Way-Opener under his captain and friend Gabriel Lan. After Lan was transformed into Air-Walker, Kril and his ship pursued Galactus in the hope of rescuing his friend. However, he did not catch up with Galactus until years later, at a point after both Air-Walker and the Air-Walker Automaton had been slain.



Ignorant of his friend's death, Kril confronted Galactus and demanded Lan's release. Galactus was impressed enough by Kril's bravado that he offered Kril information on Lan's fate in exchange for Kril becoming his next Herald. Kril accepted and was transformed into Firelord.

Firelord acted as a Herald for a relatively short time. He was freed from Galactus' service when Thor traded Galactus the Destroyer robot in exchange for Firelord's freedom. For a time Firelord resided peacefully on Earth. He finally returned to Xandar, only to discover it had been destroyed by the supervillainess, Nebula. Firelord then joined Starfox in hunting her down.

**RUNNING FIRELORD:** Firelord is a valiant warrior who respects others who fight honorably. Should he decide on a course of action, nothing short of crushing defeat will dissuade him from his path.

## DESTROYER

F	UN	(100)	Health: 3275
A	MN	(75)	
S	UN	(100)	Karma: 100
E	CL3000		
R	N/A		Resources: N/A
I	N/A		
P	UN	(100)	Popularity: -100

### KNOWN POWERS:

**Robotic Body:** The Destroyer is an enchanted suit of armor. The armor is constructed of magical metal far stronger than virtually any other substance. All its powers are derived from enchantments Odin incorporated into the armor when he built it.

**Mind Transferral:** The armor cannot be disassembled, hence it cannot be actually worn. Rather, it becomes activated by the life force of the user. There are three ways a user can activate the armor. One, the user may willingly transfer his life force into the armor if he is within 10 feet of it. Two, he may accidentally be drawn into it if he touches the armor; in this case he must make a Psyche FEAT of Monstrous intensity to avoid the transferral. Three, an astral traveller may send his Astral Body to possess the armor.

The user can control the Destroyer and its powers as if it were his natural body. For game purposes, the user's Reason and Intelligence ranks fill the N/A ranks above. The user can freely operate the armor until he uses any of the armor's offensive powers or makes a FEAT roll. Once he does so, he must make a Psyche FEAT against the Destroyer's Monstrous Psyche. Failure indicates the user's personality is consumed by the armor and he becomes a relentless, mindless berserker.

**True Invulnerability:** The metal armor possesses CL3000 resistance to all forms of attack, whether physical, energy, psionic, magical, or power-related.

**Plasma Generation:** The Destroyer can emit blasts of Shift-Z rank. These blasts do flame and kinetic damage as well.

**Magnetic Generation:** The Destroyer has the ability to create magnetic fields of Shift-Y intensity.

**Molecular Conversion:** It has the CL1000 ability to transform elements and compounds at will.

**Molding:** It can rearrange the shape of matter with CL1000 ease.

**Disintegration:** It can fire blasts of C1000 rank at a range of up to 5 areas. The

beam takes two rounds to charge. Living targets may attempt a Red Endurance FEAT to avoid destruction. Even if the roll is successful, the target takes 1000 points of damage.

*Suspended Animation:* While the user possesses the armor, his body is placed in a trance that frees him from the need to breathe, drink, or eat.

**TALENTS:** None.

**CONTACTS:** None.

**BACKGROUND:** The Destroyer was constructed by Odin as a Doomsday weapon against the Celestials. As its creator, Odin was the only being who could safely control the armor. For 1000 years the armor lay hidden in an Indochina temple. After Loki discovered the armor's existence, it became a pawn in various battles involving Thor, Odin, Balder, Sif, and the Norn Queen. Finally Thor tired of its misuse and traded it to Galactus in exchange for Firelord's release from servitude. However, Galactus quickly realized the armor was ill-suited for his needs. He placed the armor into storage and forgot about it. Shortly thereafter, Loki stole it back.

The Destroyer finally filled its purpose when the Celestials returned. Odin drew the lifeforce of all the Norse gods into the suit, causing it to grow to 200 feet in height. Armed with the Odinsword, it attacked the Celestials. Unfortunately, it was ineffective and quickly defeated. Of late, Thor used the Destroyer in battle against Hela, freezing it in impenetrable ice afterwards.

**RUNNING THE DESTROYER:** The Destroyer tends to incite whoever uses it into a battle-crazed berserker fury.

## TERRAX

Tyros of Lanlak

F	UN	(100)	Health: 300
A	AM	(50)	
S	MN	(75)	Karma: 135
E	MN	(75)	
R	GD	(10)	Resources: PR(4)
I	MN	(75)	
P	AM	(50)	Popularity:-20 (50 on Birj)

### KNOWN POWERS:

*Earth Animation:* Terrax has Unearthly

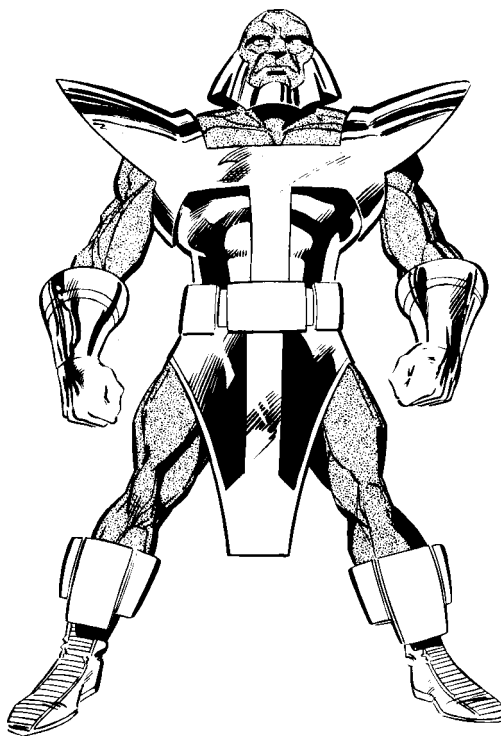

control over rock, dirt, and basic building materials. He can affect an area up to 100 miles in diameter. As power stunts he can:

- Create tremors of unearthly intensity.
- Use rock as missiles with Unearthly range and effect.
- Shape rock to serve any purpose he wants.
- Levitate with Unearthly ability any land mass measuring up to 100 cubic miles.

*True Invulnerability:* Terrax has Unearthly resistance to physical and energy attacks. He has C1000 resistance to extreme heat and cold.

*Self-Sustenance:* Terrax is free of the need to consume air, water, or food.

*Floating Disc:* Terrax can attain C1000 speed by riding atop any rock he controls with his Earth Animation power.

*Dimension Travel:* When Terrax reaches his maximum velocity, he can enter hyperspace and quickly travel to other sections of the universe.

*Life Detection:* Terrax can detect life-energies up to 5 light years away with C1000 ability.

*Axe:* Galactus gave Terrax an axe-like weapon through which he could channel his powers. The axe has C1000 Material Strength and some inherent powers:

- Force Field—the axe can emit a force

field of Monstrous rank. It is capable of completely covering the island of Manhattan.

- Disintegration—the axe has the Unearthly ability to disintegrate matter.

**TALENTS:** Terrax has Military and Astro-navigation skills, as well as Weapons Skill with his axe.

**CONTACTS:** As Tyros, he had control over his homeworld of Birj.

**BACKGROUND:** Tyros was the dictator of the city-state Lanlak on the planet Birj, a satellite of the gas giant Marman. Tyros was a mutant who already possessed the ability to animate rock and soil; he used his powers to conquer the area where he reigned as a despot.

Tyros' tyrannical nature and his powers attracted Galactus' attention. Galactus had been twice betrayed by Heralds with strong morals; he thought that an immoral Herald might serve him better. Galactus coerced the FF to recruit Tyros, which they did. Galactus transformed Tyros into Terrax the Tamer and set him off to find worlds to destroy. Instead, Terrax set about trying to destroy Galactus. He delayed locating suitable worlds and so caused Galactus' powers to decrease. Finally, Terrax decided the time was ripe to attack. He stole the entire island of Manhattan into space; there he forced the FF to aid him in destroying Galactus. Terrax underestimated Galactus' remaining power. Galactus stripped him of his power and dropped him from a height of one mile into a garbage dump.

Somehow Tyros survived. Dr. Doom's aides found him and brought him to Latveria. There Doom was working to recreate the Cosmic Power he had taken from the Silver Surfer years ago. Doom offered to give Tyros new Cosmic powers in exchange for the destruction of the FF. He did not tell Tyros that the cosmic powers tended to destroy their host in a matter of hours. Tyros agreed and had almost defeated the FF when he was distracted by Dr. Doom and the Silver Surfer. Tyros disposed of Doom by fusing his armor into an immobile shell. Then he battled the Surfer. In the battle, Tyros' barely controlled power vaporized his body. The remaining pure Cosmic Power plummeted to earth, where it vaporized Dr. Doom's body.

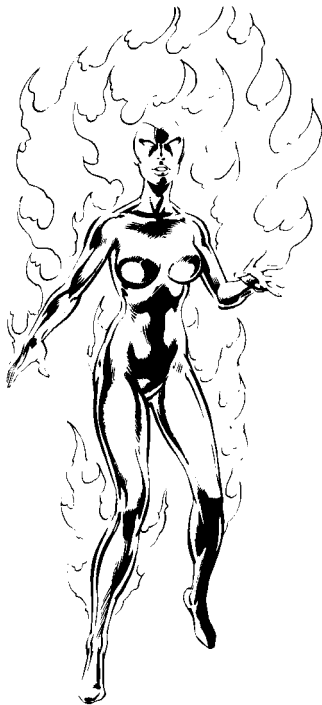

**RUNNING TERRAX:** Terrax was an irreparably vile person who believed that, since his was the strongest power, he should have controlled everything. Even being exposed to Galactus' near-omnipotence didn't dampen Terrax's ego. He simply began to work on ways to destroy anyone stronger than he was.

## NOVA II

Frankie Raye

F	AM	(50)	Health: 300
A	UN	(100)	
S	AM	(50)	Karma: 110
E	UN	(100)	
R	GD	(10)	Resources: UN(100)
I	AM	(50)	
P	AM	(50)	Popularity: 0

### KNOWN POWERS:

**Fire Generation:** Nova has the ability to generate flames that have Shift X rank damage (150 points) and range (15 miles). Her flames are hot enough to destroy a Skrull starship with a single blast. If she properly channels her energies by means of an Endurance FEAT, she can temporarily raise her power rank + 2CS. She can emit her flames from anywhere on her body.

**Fire Control:** Nova retains her original Amazing rank of Fire Control. She can absorb or control any flame, whether natural or power-based.

**Energy Sheath (Fire):** Nova's body is always surrounded by a fiery layer of Unearthly rank. This gives her rank level protection against physical or energy attacks. When combined with her other powers, it gives her C1000 resistance to temperature extremes. Matter of less than Amazing material strength melts upon contact with her body. Living targets suffer Amazing damage from touching her unless they are somehow protected from the extreme heat. As a side effect, her high body temperature makes Nova immune to any disease; infection is disintegrated upon contact.

**True Flight:** Nova can attain C1000 speeds (10,000 mph in an atmosphere; 1,000,000 mph in space).

**Gateway:** When in space, Nova can create spacewarps that enable her to quickly reach other parts of the universe. She has C5000 range on these gateways (500 light years).

**Self Sustenance:** Nova can survive indefinitely without breathing, eating, or drinking. This is fortunate since her current body temperature would vaporize any such consumables.

**Immortality:** It is unknown how long Nova will live. In a possible future, Nova is uncounted millions of years old when she returns to an uninhabited Earth. Despite her age, she is still as young as she is now.

**TALENTS:** Astro-Navigation enables Nova to roam the universe at will without getting lost.

**CONTACTS:** Her master Galactus is her main contact, although she could presumably call upon the Fantastic Four if she ever returned to Earth.

**BACKGROUND:** Nova was originally Frankie Raye (see FF Membership section). When Galactus was revived by Reed, he was near death by starvation. He desperately needed a new Herald to seek out a world for his consumption. Although she had been terrified of Galactus at first, Frankie found herself drawn to him and offered herself as his new Herald. Galactus accepted and increased her powers immensely. She then left to find him his next meal. At the present time she still has not been near Earth again. In a possible future, she does not return until uncounted millions of years have passed and mankind has vanished.

**RUNNING NOVA:** Nova has no compunction against marking worlds for destruction. As she put it, "A few less bug-eyed monsters? What's that compared to my being able to go out there?" She even revels in destruction if the intended victim should put up a defense. Her motivation for serving Galactus is a mixture of reverence and love. She sees Galactus as her god and her ideal mate.

## THE SURVIVORS' FLEET

As Galactus ravaged his way across the universe destroying world after world, he did not always completely destroy the races he fed upon. If a race had space travel, there was a chance that some of its members would be off-world when Galactus came. With their homeworlds destroyed, these survivors had to rebuild their spacecraft into space arks that could travel into interstellar space in pursuit of, or escape from, Galactus. Eventually the various Survivors rendezvoused and formed a great fleet of ships. The Survivors followed Galactus' destructive trail and assisted Galactus' newer victims when they could. While most of their time was spent maintaining their ships and life support, the Survivors also worked on ways to destroy the monster Galactus.

When word came from Lilandra, Majestrix of the Shi'ar, that Reed Richards had committed the unpardonable crime of actually reviving the dying Galactus, the Survivors acted. Reed was brought before the Survivors for trial. He was held responsible for Galactus' subsequent destruction of the Skrull homeworld and the deaths of seven billion people. In the trial that followed, Odin, Galactus, and Eternity testified to Galactus' purpose in the universe. While this did not excuse Galactus' actions, the Survivors decided that Reed only acted in compassion, not malice, when he revived Galactus. Reed was returned to Earth. Since that time, the Survivors' action are unknown. Although subdued by Eternity's testimony, their anger against Galactus remains. They retain their self-appointed task of rescuing the survivors of Galactus' newer acts of destruction. Perhaps newer Survivors will renew their age-old quest for vengeance, and the Survivors will finally act against Galactus.





## THE SKRULLS

The Skrulls are a breed of green-skinned humanoids from the Andromeda galaxy. They are a fierce warrior race who carved for themselves the oldest surviving empire in the Marvel Universe's history.

In the beginning they were a peaceful, scientifically inclined race on Skrullos, a planet in the Drax system. Almost a billion years ago the Celestials arrived and experimented on the Skrulls. They produced three races. The Skrullian Eternals were immortal. The Skrullian "normals" were capable of eventually rapidly evolving into Celestial-like beings. The Skrullian Deviants were given natural shapeshifting powers. After the departure of the Celestials, the Deviants wiped out the other two groups. All living Skrulls are descendants of the Deviant line.

Their shapeshifting powers aided the Skrulls' departure into space. When they encountered a new race, they simply transformed themselves to resemble that race. The Skrull empire that resulted from these contacts was based on free trade and mutual cooperation.

Then trouble struck. The Skrulls voy-

aged to the Milky Way and Magellanic Clouds. In the latter cluster they discovered the Kree homeworld of Hala. The Kree were in the dawn of their culture; at this point they shared Hala with the plant race, the Cotati. The Skrull decided to favor one of the races with their advanced technology and devised a test to determine which would be the favored race.

The Skrulls created the Blue Area of the Moon and transported bands of Kree and Cotati there. Both groups were left to accomplish what they could. The Skrulls judged the Cotati's works to be superior. This angered the Kree and led to a vicious attack in which the Kree band slew the Skrull judges and the Cotati. The Kree stole the Skrull's starship and technology. Because of the immense distances involved, decades passed before the Skrulls learned of the Kree's activities. By this time it was too late. The Kree were now advanced and audacious enough to attack the Skrulls in their home galaxy. During the millennia that followed, the Skrulls developed the vicious streak needed to conduct intergalactic war. Their entire culture was remade in the warrior image.

100,000 years ago the Skrull capitol

was relocated to Tarnax IV, now renamed Throneworld. The empire is controlled by an Emperor and each of the 978 worlds is controlled by a Governor. Recently Throneworld was devoured by Galactus and the Imperial starfleet destroyed by Nova (11). With the destruction of a central government, the Skrull Empire has collapsed into hundreds of bickering factions. Their galaxy is filled with Governors who have declared themselves to be "Emperor."

The greatest blow to the Skrulls has been the destruction of their shapeshifting powers. This was accomplished by Reed Richards and yet another Governor-turned-Emperor.

Skrulls became aware of Earth when they discovered a space warp linking Earth and Throneworld. Later they discovered the Earth possesses an equidistant link to Hala. They see Earth as a world to conquer but they are content to hold off a full invasion. (Perhaps they are afraid the Kree would learn of the plot.) Because of their caution, the Skrulls have sent only a handful of scout-warriors to infiltrate Earth. These have included Super-Skrull and Skrull-X.

The Skrulls recently broke a peace treaty with the Kree. They maintain their military drive and prefer to fight rather than negotiate. Among the other races contained within the Skrull Empire are the Druff, Guna, Kallusina, Morani, Pheragot, Queega, Tekton, and Yirbek races. Other races remain independent, whether through treaties or open resistance. Such races include the Clegrimites, Gegku, Krylorians, Wilameanis, and Xandarians. The war with the Xandarians recently ended with the destruction of Xandar by the supervillainess Nebula.

### NOTABLE SKRULLS:

**ANELLE:** Princess and daughter of R'Kill and Dorrek. Super-Skrull wanted her for his mate. She died along with her mother and Throneworld.

**DORREK:** Emperor, R'Kill's husband, and Anelle's father. He gained the throne by assassinating R'Kill's father, the previous Emperor. Dorrek was the driving force behind the early Skrull attacks on Earth and the FF in particular. His ego demanded the FF be punished for daring to defeat his plans.

**DREXXON:** A "Scanman," a Skrull observer and sensor operator.

**HAGAR:** The High Judicator, the leader of the Skrull judiciary.

**JAKETCH:** An apprentice executioner who shot Reed, Sue, and the Thing with an accelerated-aging ray. He detests Hagar and years for the day he can execute him.

**RAKSORR:** This Skrull officer may be the most important Skrull in recent history. He was originally sent to observe the Shi'ar-ordered trial-by-combat of Jean Grey/ Phoenix and the X-Men. His interference with the trial lead to a fight with the Kree observer, Bel-Dann. That fight lasted for months, long after the Shi'ar had departed and Attilan arrived. The Watcher told Empress R'Kill and the Kree Supreme Intelligence of their long duel. This lead to the rulers signing an agreement whereby the the combatants were now representing their races. The winner would also determine the final victor in the Kree- Skrull War. The combat continued and eventually involved the Inhumans and the FF. Reed concocted a plan whereby Raksorr and Bel-Dann had to cooperate to defeat the FF and Inhumans. After their victory, the Watcher declared the contest a draw. The Kree and Skrull races were declared equals and the long war was finally over.

**R'KLLL:** Empress. She avenged her father by assassinating her husband, the Emperor Dorrek. Her reign following Dorrek's death was marked by several attempts at peace-the end of the war against Xandar and the treaty ending the Kree war-and the destruction of Homeworld. She died along with several billion of her people.

**SKRAGG:** A warrior.

**SKRULL-X:** A Skrull-shaped robot created to be the Super-Skrull's superior and successor.

**SUPER-SKRULL:** The Skrull's greatest warrior. He was Dorrek's chosen champion but alienated Dorrek when he revealed his desire for Anelle.

**WARLORD MORRAT:** Head of Skrull's military. He engineered the plot against the FF that resulted in the death of Franklin Storm (Sue and Johnny's father).

**XALXOR:** Pilot of Dorrek's flagship.

**ZENDRAO:** After Galactus' and Nova's destruction of Throneworld, Zendrao found himself Commander of the largest remaining Skrull fleet. He is concerned with reforming the Skrull Empire. However, he does not want to be the titular head of it, but rather be the power behind the throne. He views the current Skrull civil war for supremacy as a useless waste of time; rather than join any

side he uses his fleet to keep the combatants away from areas he is protecting.

### SKRULL (Typical Warrior)

F	GD	(10)	Health: 28
A	TY	(6)	
S	TY	(6)	Karma: 22
E	TY	(6)	
R	GD	(10)	
I	TY	(6)	
P	TY	(6)	

#### KNOWN POWERS:

**Shapeshifting:** All Skrulls possess the ability to spontaneously alter their appearance to that of any living thing. They could even modify parts of their bodies to imitate the appearance and properties of clothing, equipment, or secretions connected with the original. Recently Reed was able to destroy this ability in all surviving Skrulls throughout the Marvel universe.

#### WEAPONS

**Blaster Pistols:** The typical Skrull sidearm is a raypistol that fires a Plasma blast of Remarkable rank. The weapon can do Remarkable concussive damage, Good heat damage, and Good radiation damage. The accuracy of the pistols limits their effective range to 7 areas.

**Aging Ray:** This is an Executioner's weapon. The Skrulls want victims to suffer, hence they devised a slow and nasty method of execution. The Aging ray is a small pistol that the equivalent of the power Biophysical Control (Aging) at C5000 rank. Victims of the ray fall unconscious for 1-10 turns. Then they begin to age at a rate 5000 times faster than normal. For a normal human, this means the victim dies in 1-6 days. Once the aging has begun, it can only be reversed by another blast from a specially modified Aging ray; the ray can be modified by a Reason FEAT of Incredible rank. The range of the Aging ray is limited to 20 feet, or 1 area.

**TALENTS:** All Skrulls are trained in Martial Arts E. They are proficient in Military Science, Astro-navigation, Espionage, and Starship Piloting, Engineering, and Combat.

**CONTACTS:** A Skrull never comes to anyone's help unless he can gain greater

power by it; therefore no Skrull has any usable Contacts except for his or her minions.

**RUNNING A SKRULL:** The typical Skrull encountered during an adventure is a member of the Skrull military (it is unknown if there even is such a thing as a civilian Skrull). While the average Skrull will fearlessly and loyally execute any duties, he will also try to find ways to better his own position. A Skrull will betray another Skrull if it is to his own advantage.

### SUPER-SKRULL

F	RM	(30)	Health: 150
A	EX	(20)	
S	AM	(50)	Karma: 22
E	AM	(50)	
R	TY	(6)	Resources: FE(2)
I	TY	(6)	
P	GD	(10)	Popularity: 0

#### KNOWN POWERS:

**Shapeshifting:** Super-Skrull has an enhanced form of the natural ability of all Skrulls to transform into any desired shape. Whereas most Skrulls have Typical Shapeshifting, Super-Skrull has an Unearthly rank.

**Elongation:** This is an application of his Shapeshifting power. It enables him to stretch any part of his body up to three areas away with Unearthly ease.

**Fire Generation:** Super-Skrull has the ability to emit flames of Monstrous intensity and range.

**Fire Control:** He has Monstrous control over flame, whether it is naturally occurring or created by himself.

**Rocket Flight:** He can fly at Incredible speed by emitting a stream of flame from his lower legs.

**Armor Skin:** The Super-Skrull's leathery hide gives him Remarkable Resistance to physical and energy attacks. As a Power Stunt combining this power with Shapeshifting, he can mimic the Thing's rocky hide to gain Incredible protection.

**Invisibility:** He has the Excellent ability to render himself undetectable by visible, ultra-violet, and infra-red light.

**Force Field Generation:** The Super-Skrull has the power to create invisible force fields of Amazing strength.

**Power Selection:** Despite his wide array of powers, the Super-Skrull cannot use more than four of them at any one time.

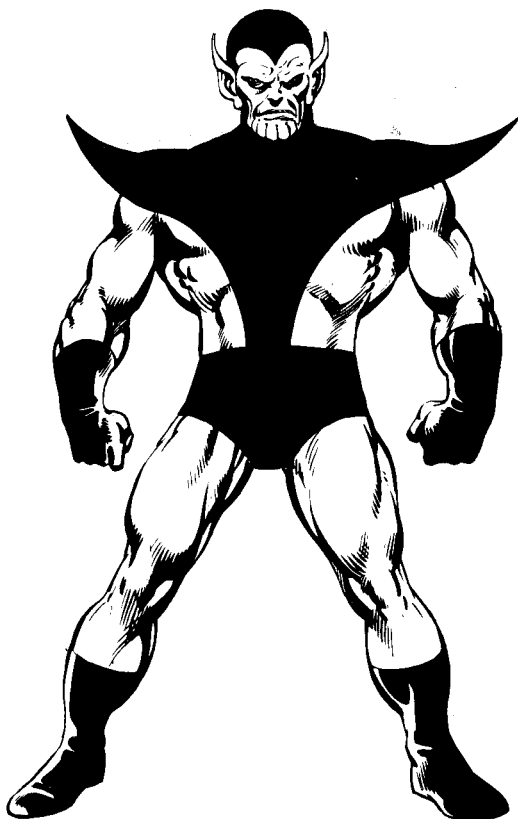

The Shapeshifting and Armor Skin powers are automatically in constant use. This limits the Super-Skrull to but two chosen powers. He can switch powers at will.

**Power Source:** The Super-Skrull derives his enhanced powers from cosmic ray projectors that gather the energy and directly relay it to him. If he is removed from contact with the power beam, he is dependent on available cosmic energy; subsequently his powers drop -2CS.

**TALENTS:** The Super-Skrull is a trained warrior proficient in Martial Arts C and E and advanced weapons systems using Skrull or Kree technology. He is skilled in Espionage, Astro-Navigation, Piloting, and Survival Skills. He is a master of Hypnosis.

**CONTACTS:** The Super-Skrull was originally the chosen champion of the Skrull Emperor Dorrek and the leader of all the Skrull special operatives.

**BACKGROUND:** The Super-Skrull was created for the express purpose of avenging the Skrulls when the FF defeated their first scouts. The toughest, most dangerous Skrull warrior was given

powers equal to the FF. Unfortunately, he was defeated when he first battled the FF. The Skrulls devised a stronger power beam to increase his strength level. That didn't work either. The Super-Skrull was sent into exile.

Years later he was summoned by Dorrek to return to Earth and battle the Kree Captain Mar-Veil. He was initially defeated but later managed to kidnap Mar-Vell, Scarlet Witch, and Quicksilver. After the Kree-Skrull War ended, Super-Skrull joined the service of Thanos. Then he was stranded on Earth without a way home. His attempt to build a starship ended with his being trapped in a disembodied form with the Van Allen Belt. The Belt's radiation had a deteriorating effect on him; when he was accidentally released by Canadian astrophysicists, he developed a fast-spreading form of cancer. Although he is once again trapped in the Van Allen Belt in a disembodied state, it is likely that he will quickly die if he is released again.

Note that the Super-Skrull was in this disembodied form when Reed unleashed the radiation that destroyed the shape-shifting powers of all Skrulls. It is possible that the Super-Skrull retains his powers, although it is unknown if he could live long enough to use them.

**RUNNING SUPER-SKRULL:** The Super-Skrull believes he is the finest, most powerful warrior in the known universe and parts beyond. He maintains a loyalty to the Skrull Empire that persists even when it has turned against him. Somewhere along the way, the Super-Skrull decided that Princess (later Empress) R'KIII was his ideal mate. Because he has been trapped in the Van Allen Belt for some time, he does not know that the Skrull Homeworld was destroyed and R'KIII killed.

## SKRULL-X

F	IN	(40)	Health: 165
A	RM	(30)	
S	AM	(50)	Karma: 14
E	MN	(75)	
R	TY	(6)	Resources: none
I	TY	(6)	
P	FE	(2)	Popularity: 0

### KNOWN POWERS:

**Robotic Body:** Skrull-X is a robot designed to mimic the appearance and

powers of a Skrull warrior.

**Shapeshifting:** It has the Amazing ability to transform itself into any appearance it wants. This power can be developed into Power Stunts that duplicate some of the FF's powers.

- Elongation—Amazing rank.
- Armor Skin—A simulation of the Thing's rocky hide that gives Skrull-X Amazing protection from physical and energy attacks.

**Energy Sheath:** It can surround itself with a fiery sheath of Incredible Intensity. This provides it with power rank protection against physical and energy attacks. It also automatically melts any weapon of less than Amazing material strength.

**Fire Generation:** it can fire blasts of Unearthly intensity from its hands.

**Invisibility (Physics type):** It has the Good ability to render itself invisible to normal vision.

**Force Field:** It can generate a force field of Amazing material strength.

**Plasma Generation:** It can fire a blast of Incredible Intensity from its hands.

**True Flight:** The robot can attain Excellent speed no matter what shape it is in.

**TALENTS:** Skrull-X is programmed to be a warrior and Spy. He is also programmed in Astro-navigation and Piloting skills.

**CONTACTS:** Skrull-X is owned by the Skrull ruler.

**BACKGROUND:** The Skrull rulers realized that the living Super Skrull had too many limitations, ones that led to his embarrassing defeats by the FF. They ordered the construction of a robot that could mimic the natural powers of a Skrull and those of the FF. Unlike his predecessor, the Skrull-X robot could use all of his powers simultaneously. While this made him a deadlier foe against the FF it could not ensure his victory. He battled the FF several times before he was finally destroyed by the Human Torch. While the Skrulls presumably retain the designs that would enable them to construct more Skrull-X's, they have not yet done so.

**RUNNING SKRULL-X:** Skrull-X is programmed to be an assassin. It would conceal its identity, nature, powers, and mission until it is about to strike. Although it is a robot, it is as intelligent as a normal Skrull. The fact that it is a robot





is known to very few beings. The FF only discovered this fact when the Human Torch finally melted it into oblivion.

## THE FRIGHTFUL FOUR

This supervillain team is the FF's oldest adversarial group. The Frightfuls formed when the Wizard, Trapster, and Sandman joined together in an attempt to defeat the Human Torch. After gaining the reluctant participation of Madame Medusa, the group gained their name and felt confident enough to take on the FF. They fought the the FF on several occasions before Medusa regained her memory and betrayed them. The team's stubborn fixation on maintaining the name "Frightful Four" led to their admission of Thundra as a new member. Eventually she betrayed them as well. The Wizard swore off ever again admitting a woman into the team. In a move of surprising bravado, the Frightfuls captured the FF and held an open audition for new criminals within the FF's own headquarters. At this time the group added the Brute; however the Brute soon abandoned the Frightfuls in favor of impersonating Reed. The Frightfuls later combined with Electro and later Llyra in final attempts to justify their name. The

group finally fell apart when the Sandman beached his career as a criminal and the Wizard and Trapster had a major argument.

Despite their various team rosters, the Frightful Four remained an inferior team of supervillains. They were at least sub-consciously aware of their inadequacies and plotted strategies that made up for what they lacked. The team made an art of the ambush and sneak attack. (When attempting such an act, their Karma pool temporarily doubles.) The team also believes in impressive public relations and have successfully created the public perception that they are as dangerous as, say, Dr. Doom.

## WINGLESS WIZARD

F	PR	(4)	Health: 40
A	GD	(10)	
S	TY	(6)	Karma: 52
E	EX	(20)	
R	IN	(40)	Resources: EX(20)
I	TY	(6)	
P	TY	(6)	Popularity: 10

### KNOWN POWERS:

**Hyper-invention:** The Wizard has Amazing inventiveness in the fields of applied physics, sub-atomic particles, and other dimensions. He can cobble together various high-technology items that utilize these fields if he can get sufficient resources together. Unfortunately, most of the materials he needs are in the hands of others, such as the FF.

**Anti-gravity Discs:** The Wizard invented these little gravity-defying wonders. They possess Good Gravity Manipulation. This permits each disc to carry a mass of up to 400 pounds at Typical airspeed. The discs possess Monstrous Bonding courtesy of, a layer of the Trapster's special glue; the glue is inert until activated by the action of pressing the disc against a target. The discs are remotely controlled by computers within the Wizard's costume. A supply of them is stored in the Wizard's chestplate and dispensed through a circular opening in front.

**Power Gloves:** These special gauntlets contain a number of useful devices. They contain the controls for remotely operating Anti-Gravity Discs. They also contain mechanisms for these powers:

**Electricity:** They can fire an Incredible blast at Poor range.

**Force Field:** Remarkable rank.

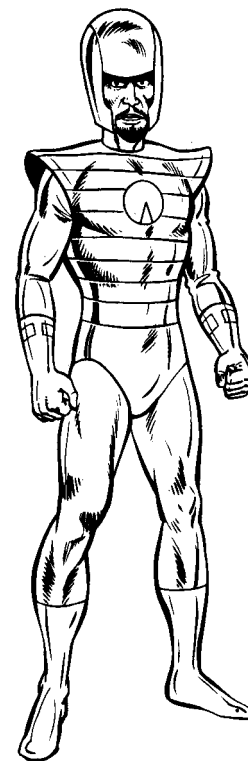

**Hyper-Strength:** applied gravity manipulation raises his Strength to Excellent.

**Body Armor:** His suit gives him Good protection against physical attacks.

**Flight:** permanently mounted Anti-Gravity Discs give him Good airspeed (140 mph).

**Mind Control:** Devices within his helmet combine with external devices to give him the Excellent ability to control another person's mind. The Wizard has used the "Id Machine" to release targets' hostility, command their actions, or reduce them to a zombie-like state.

**TALENTS:** The Wizard is a genius in the fields of applied physics, sub-atomic particles, and other dimensions.

**CONTACTS:** The Wizard is the founder of the Frightful Four. He is currently estranged, even hostile toward all his former allies.

**BACKGROUND:** The Wizard began his career as a celebrated physicist, inventor, and stage magician. He amassed a sizeable fortune creating specialty high-tech items for the wealthy. Eventually he got bored and chose the challenge of defeating first the Human Torch and then

the entire FF. A chance teaming with the Trapster and Sandman inspired the Wizard to form the Frightful Four. When he encountered the then-amnesiac Medusa wandering Europe, he convinced her to join his group.

After his split with the Trapster, the Wizard decided to return to being a solo act. He has since suffered the humiliation of being defeated by Franklin.

**RUNNING THE WINGLESS WIZARD:**

The Wizard wants power, glory, and most of all, a challenge. When he realized that Reed had amassed a treasure trove of high-tech items in the Baxter Building, the Wizard decided he had to have them. Many of his plots for the Frightful Four revolved around his fixation on plundering the Baxter Building.

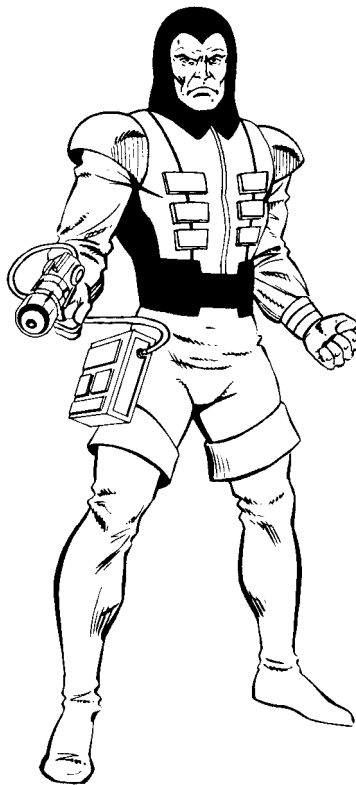

**TRAPSTER**

**Peter Petruski a.k.a. Paste Pot Pete**

F	PR	(4)	Health: 28
A	GD	(10)	
S	PR	(4)	Karma: 40
E	GD	(10)	
R	EX	(20)	Resources: GD(10)
I	GD	(10)	
P	GD	(10)	Popularity: 10

**KNOWN POWERS:**

*Hyper-Invention:* The Trapster has Remarkable ingenuity in creating devices and chemicals related to the field of adhesives. He can create adhesives and weapons out of whatever materials are on hand.

*Paste Gun:* This is a large pistol linked by tube to a chemical canister worn on the right hip. The gun can fire a stream of glue at a range of 2 areas. The glue is flameproof and possesses Monstrous adhesion against anything it contacts. It also acts as a Grappling attack of Monstrous Strength. The glue remains liquid in its canister and does not set until 10 seconds after it is fired from the Paste Gun. The glue crumbles when exposed to ultra-violet light. Normal sunlight crumbles the glue in 5 hours; higher intensi-

ties of UV light may decrease this time considerably.

The Paste Gun has a variable nozzle. It can fire a fine line up to 2 areas away. Alternately, it can be set to flood an area. The pistol can flood a 10 foot cube within 15 seconds. As a power stunt, the Trapster has learned how to fire a line at a target and retract it quickly, thus drawing the target to him if the object is lighter than he. If it's heavier, the Trapster is drawn to it. By this method the Trapster can traverse space or hitch a lift on flying vehicles, much in the manner of Spider-man.

*Traps:* The Trapster carries a variety of spring-loaded spheres. These devices have Excellent material strength. When activated, they snap open to reveal a series of balls and discs; these rebound erratically and lock onto the limbs of anyone they hit. A second type of trap is based on the use of "memory wire"; when activated they spring out to form a predetermined shape. These are also used to ensnare or attack targets.

*Wall-walking Boots:* These boots were recently created to give the Trapster Remarkable Wallclimbing. The boots contain reservoirs of glue dispensed through the soles. Sensors in each sole release small quantities of glue when the boot is pressed against a vertical or inverted surface. The glue sets instantly, allowing the Trapster to stand on the surface. When he arches his foot to take another step, the sensors release a new flow of glue that detaches the previous, dry glue and adheres his boot to the new spot. Special braces in the leggings assist the Trapster in walking in horizontal and inverted modes.

**TALENTS:** The Trapster is a superb chemist specializing in adhesives and delivery mechanisms.

**CONTACTS:** He is a founding member of the Frightful Four but is currently estranged from all its past members.

**BACKGROUND:** Peter Petruski was a research chemist who invented an extremely adhesive "multi-polymer" liquid. He decided to use his invention to begin a career as a supercriminal. He had a series of defeats at the hands of the Human Torch and ended up in prison. He won a special parole when he gave the Avengers a solvent for Baron Zemo's "Adhesive X" He used his free-

dom to redesign his equipment and develop stronger adhesives. He then joined the Frightful Four. He remained with the group until he and the Wizard finally fell out over professional disagreements. Shortly before its destruction, the Trapster invaded the Baxter Building in an attempt to plunder it. Unfortunately he fell afoul of the building security systems and became the first person ever to be defeated by an empty building.

**RUNNING THE TRAPSTER:** Like the Sandman, the Trapster is primarily a thief rather than a conqueror, but, like the Wizard, he has sights on more glamorous prizes, such as missiles or arcane inventions. The Trapster also suffers from a bit of an inferiority complex; he is aware that he appears to be a ludicrous villain with an outlandish weapon. He is still trying to live down his original name, "Paste Pot Pete."

## SANDMAN

William Baker a.k.a "Flint Marko"

F	RM	(30)	Health: 175
A	RM	(30)	
S	IN	(40)	Karma: 46
E	MN	(75)	
R	TY	(6)	Resources: TY(6)
I	GD	(10)	
P	RM	(30)	Popularity: 0

### KNOWN POWERS:

*Mineral Life:* As the result of a freak accident, Baker was transformed into living sand. The sand functions identically to, and appears to be, normal flesh. However, Sandman can at will convert parts of his body to normal appearing, animate sand. Topology: The Sandman can remold his body into any shape he wants. This can be used to do such acts as:

- Form a hammer that does Amazing damage against a target.
- Form a cage of Incredible material strength.
- "Phase" through openings with Remarkable ease.
- Elongate by reshaping his body into longer shapes. His maximum length is 2 areas.

*Armor Skin:* Sandman's altered body gives him Amazing protection against physical attacks and Incredible protection from most energy attacks, excluding heat-based attacks (see below).

*Sandblast:* Sandman has the Incredible ability to fire a damaging spray of sand at



a target up to 2 areas away. The sand does Incredible damage or can be used as an Incredible Grappling attack. Since the sand is part of his body, it eventually returns to him.

*Molecular Conversion:* Sandman has the ability to ingest new sand and convert it into the special type of sand that forms his body. In this way he doesn't have to worry about gradually whittling himself away to nothingness.

*Healing:* By using his Molecular Conversion power to give him new sandy "flesh," he can Heal up to half his damage per day.

**WEAKNESS:** Due to his peculiar chemical nature, the Sandman has three weaknesses. The first is an aversion to heat and flame. He has no defense against such attacks. The resultant damage occurs as his sandy flesh fuses into immobile glass. Note that such glass is sloughed off as he Heals. If his entire body is transformed into glass, there is a possibility that he would die. A red Endurance FEAT means that he is still alive but trapped as an immobile glass statue. The statue would have to be pulverized before he could regain animation.

The Sandman has a second weakness

to high winds of Incredible strength, such as are generated by a vacuum cleaner. Such winds reduce him to a helpless mass of loosely blowing particles.

The third weakness is a susceptibility to water-based powers of Monstrous rank or any being whose body form is Liquid Life. In such cases, Sandman finds that he involuntarily is absorbed by the aquatic medium. A red Psyche FEAT is needed to retain control of his body.

**TALENTS:** Baker was a petty criminal without skills.

**CONTACTS:** He is a founding member of the Frightful Four. After he renounced his criminal past, he became friends with the Thing and has helped him in battles against other supercriminals.

**BACKGROUND:** Baker was originally a brutal gangster whose crimes got him sent to Ryker's Island. When he escaped he fled south and eventually hid in a military nuclear test site near Savannah, Georgia. A freak accident involving radioactive steam transformed Baker into living sand. After he learned to control his powers, he returned to NYC to become a supervillain. He originally worked solo but soon joined the Wizard in the new Frightful Four. Unfortunately his success record as a team member was not much better than his solo record. He finally split with the Frightful Four (er, Frightful Two) to join with Hydro-Man, a supervillain who could transform his body into living water. That led to the discovery of his third weakness when he and Hydro-Man freakishly merged into a mindless mass of mud.

When he and Hydro-Man finally managed to regain their independence, Baker decided he'd had enough. He turned his back on his criminal past and reformed. The Thing is helping him through the process.

**RUNNING SANDMAN:** Sandman was the basic blue collar supercriminal. He used his powers to rob rather than extort or conquer the world. Although the Wizard showed him higher goals in the fields of technological theft and world conquest, the Sandman's heart was never in it.

His concerns now are in living down his past and making amends for past crimes by battling current criminals. He is the Thing's drinking buddy and occasional partner in crimestopping.



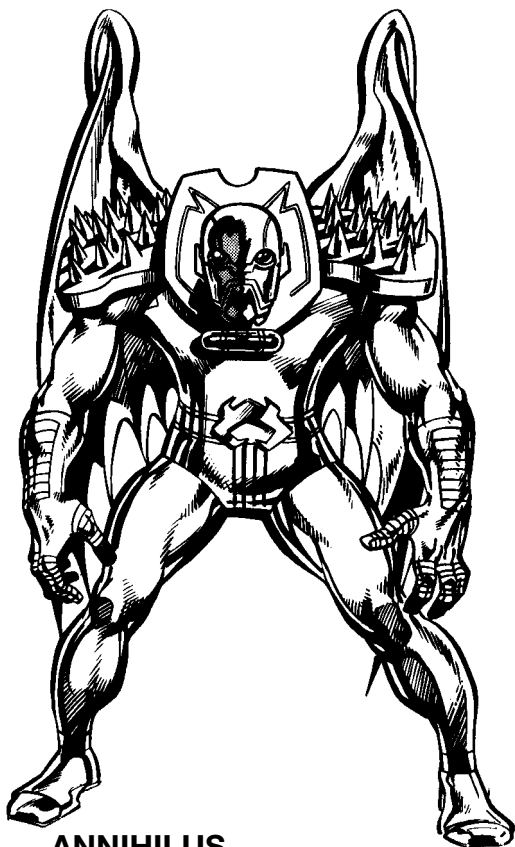

**ANNIHILUS**  
Annihilus of Anthros

F	IN	(40)	Health: 205
A	IN	(40)	
S	AM	(50)	Karma: 70
E	MN	(75)	
R	RM	(30)	Resources: MN(75)
I	GD	(10)	
P	RM	(30)	Popularity: -30

**KNOWN POWERS:**

*Body Armor:* Annihilus wears a suit that gives him Incredible protection from physical and energy attacks.

*Winged Flight:* He can attain Remarkable speed.

*Self-Sustenance:* He can survive up to a year without fresh air or food.

*Cosmic Control Rod:* Annihilus' weapon and tool collects cosmic energy and provides its user with several useful powers. If he loses the Rod, Annihilus is -3CS on all FEATS, begins to age, and loses Endurance at the rate of 1CS each week.

- Flight—Amazing speed.
- Immortality
- Regeneration—Amazing rank.
- True Invulnerability—Amazing rank.
- Radiation Emission—Cosmic ray blasts

- of Unearthly intensity.
- Kinetic Bolt—Unearthly intensity.
- Molding—He can reshape inorganic matter with Unearthly ability.

**TALENTS:** Annihilus is an engineer.

**CONTACTS:** None.

**BACKGROUND:** Annihilus is an artificial being created in the Negative Zone by a crashed Tyannese ship. When he explored the ship he discovered a knowledge transference helmet that gave him the full range of Tyannese science and technology. He used that knowledge to build his Rod from debris. He also developed mastery over the insect-like lifeforms that arose on his world. He then set out to conquer the rest of the Negative Zone.

Annihilus developed a psychotic fear of aging and death. He attacked and destroyed anyone he thought might try to take his Rod and threaten his existence. This prompted him to attack the FF several times when they explored the Negative Zone. He finally lost his Rod to Blastaar. As Annihilus began to age, he went mad. He managed to break into the Baxter Building when the FF went on their extended exploration of the Zone. With the equipment of the Baxter Building at his command, he built a giant force field that would have merged the Earth and its Negative Zone counterpart, destroying both. Fortunately the FF returned in time. In a pitched battle, Annihilus was apparently slain when he plunged into that other world's atmosphere.

He was, in fact, rescued by a gloating Blastaar. Through the intervention of the FF, Annihilus regained his Rod. He now continues to plot in the Negative Zone.

**RUNNING ANNIHILUS:** Annihilus is a raging paranoid psychotic who will try to destroy anyone or anything that he believes threatens his existence.

**BASILISK**  
Basil Elks

F	TY	(6)	Health: 82
A	TY	(6)	
S	EX	(20)	Karma: 32
E	AM	(50)	
R	TY	(6)	Resources: PR(4)
I	TY	(6)	
P	EX	(20)	Popularity: 0



**KNOWN POWERS:**

*Radiowave Generation (Microwaves):* Basilisk can emit a stream of Incredible Intensity from his eyes. The beam has power rank damage and range. He developed this power into a variety of other powers.

*Cold Generation:* He has the Poor ability to cool a target's surface 40 to 160 degrees. A layer of ice would appear on the target when this power was used.

*Geoforce:* He has the Excellent ability to increase volcanic activity, even in previous non-volcanic areas (such as the Hudson River).

*Heat Generation:* He can do Excellent damage to targets by heating their interior with his microwave emissions.

*Plasma Generation:* He can fire blasts that do Incredible physical damage, Excellent heat damage, and Excellent disruption to radio transmissions and electronic devices.

*Self-Sustenance:* He can go for several months without food or water.

*Teleportation:* Amazing rank.

*True Invulnerability:* Excellent rank.

*Whirlwind:* Basilisk can attain Remarkable airspeed by creating heated columns of air.

*Body Armor:* Basilisk's costume gives all his body but his head Incredible protection.

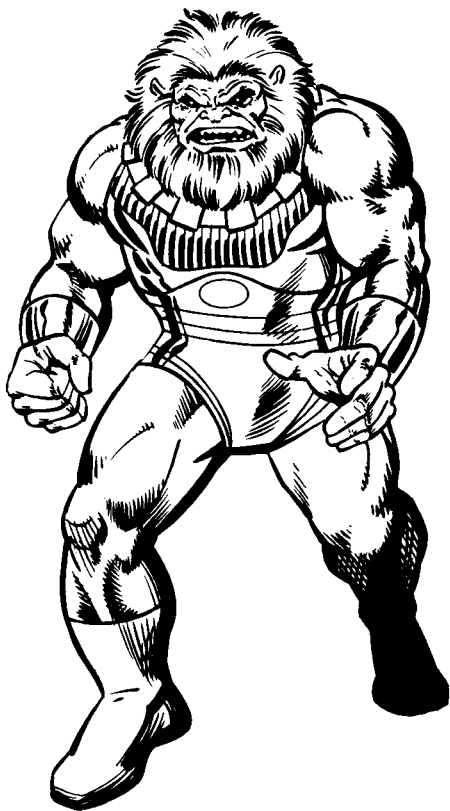

**TALENTS:** Basil Elks is a petty criminal with negligible skills.

**CONTACTS:** None.

**BACKGROUND:** Basil Elks was an unsuccessful petty criminal. He attempted to steal the Alpha Stone, a Kree power source. During the robbery, a guard's bullet shattered the stone; the explosion engulfed him and transformed him into Basilisk. He discovered the existence of another Kree gem, the Omega Stone, and sought it to further increase his powers. He fought Mar-Veil, Spider-Man, and the Mole Man's Subterranean horde before he finally gained its powers. He decided to destroy civilization with a series of volcanic eruptions. He was defeated when the Thing trapped him within one of his own volcanoes. Basilisk spent several months freeing himself and digging to the surface. He appeared in the basement of the just-completed Four Freedoms Plaza and was unceremoniously shot and presumably killed by Scourge.

**RUNNING BASILISK:** Basil Elks was an insecure person who wanted to lash out at the world that mocked him.

## BLASTAAR

### Blastaar of Balur

F	EX	(20)	Health: 180
A	GD	(10)	
S	AM	(50)	Karma: 40
E	UN	(100)	
R	GD	(10)	Resources: EX(20)
I	GD	(10)	
P	EX	(20)	Popularity: 2

#### KNOWN POWERS:

*Energy Blasts:* Blastaar can emit a damaging stream of neutrons from his hands. These blasts do Monstrous damage but have only Excellent range (5 areas).

*Rocket:* Blastaar can fly by releasing controlled neutron blasts from his fingers.

*Body Armor:* Blastaar has a thick hide that gives him Remarkable protection.

**TALENTS:** As a natural warrior, Blastaar has Excellent Reason regarding military matters.

**CONTACTS:** Blastaar had previously allied himself with Annihilus and the Sandman.

**BACKGROUND:** Blastaar was once dictator of Baluur, his native world within the Negative Zone. Rebel forces captured him and set him adrift in the debris near the gateway to the Marvel universe. Unfortunately, Reed's first entrance into the Negative Zone released Blastaar. Blastaar has attacked the Earth several times but to no avail. He later reconquered Baluur and has since led his people in carving an interstellar empire within the Negative Zone.

**RUNNING BLASTAAR:** Blastaar is a ruthless, relentless warrior who believes his raw power will overcome any enemy.

## ELSPETH CROMWELL

F	FE	(2)	Health: 16
A	PR	(4)	
S	PR	(4)	Karma: 80
E	TY	(6)	
R	GD	(10)	Resources: EX(20)
I	RM	(30)	
P	IN	(40)	Popularity: 30

#### KNOWN POWERS:

*Magic (Summoning):* Cromwell has the

Remarkable ability to Summon supernatural beings to do her bidding. Unfortunately, she could also Summon higher beings who were simply using her Summons as an excuse to invade the Earth-Dimension. When she Summoned a demon, she could use its power to perform various Power Stunts, including:

- Power Negation—She could penetrate Sue's Monstrous rank force field.
- Electrical Generation—She could emit Remarkable intensity shocks.
- Remarkable intensity Light Emission.
- Exorcism—Cromwell has the Remarkable power to drive disembodied beings out of the bodies they currently possess, freeing the original mind of that body. She could force supernatural beings of less than Remarkable Psyche to return to their home dimension.

**TALENTS:** Cromwell possesses a Mystic Background and a formidable range of Occult Lore.

**BACKGROUND:** Twenty years ago Elspeth Cromwell discovered that supernatural forces did exist. She dedicated her life to stopping them. She studied the arcane knowledge known as "Black Magic" because "only fire can stop fire." She became proficient at conjuring demons and using their powers for her own ends. Unfortunately she never realized the demons were in fact using her. They willingly answered her summons because this enabled them to rampage on the Earth. However, to stay on Earth they needed to shed the blood of an innocent. Since Cromwell never used them against someone who fit that requirement, they were required to return when their task was completed. Then Cromwell was called to Belle Porte to exorcise a house full of demons masquerading as the human Benjamin family (in fact, Reed, Sue, and Franklin). In the battle that followed, Franklin cut his head, thus providing the split blood of an innocent. As Cromwell realized what she had done, Mephisto appeared. Although Franklin eventually freed himself and his parents from Mephisto, Cromwell was not so lucky. As the price for her tampering, she lost her life and soul.

**RUNNING CROMWELL:** She was obsessed with battling the forces of darkness. The ends justified the means, no matter how drastic.

## DARKOTH THE DEATH DESTROYER

Maj. Desmond Pitt

F	AM	(50)	Health: 150
A	EX	(20)	
S	AM	(50)	Karma: 12
E	RM	(30)	
R	PR	(4)	Resources: none
I	TY	(6)	
P	FE	(2)	Popularity: -20

### KNOWN POWERS:

*Cyborg Body:* Pitt's original form was first mutated then augmented with weapon and life-support systems. Sections of the skeleton were replaced by steel fittings (Monstrous Material Strength). Fingers were equipped with steel talons (Incredible damage). A prehensile tail was added (Good damage). Antennae called "Firehorns" were added to focus Darkoth's psionic powers.

*Armor Skin:* Darkoth's leathery hide gave him Amazing protection from physical attacks and intense heat.

*Heat Emission:* Darkoth could create heat waves of Amazing Intensity.

*Kinetic Bolt:* Darkoth could emit blasts of Excellent intensity.

*Mind Control:* Darkoth had the Excellent ability to induce insanity.

*Phasing:* Darkoth could become intangible with Excellent rank.

*Winged Flight:* The small bat-like wings on Darkoth's ankles gave him Typical flying speed.

**TALENTS:** Pitt was a skilled test pilot.

**CONTACTS:** Pitt had the Thing and the USAF as Contacts. Darkoth had none.

**BACKGROUND:** Major Pitt was a fellow test pilot with Ben Grimm. Though their lives went in different directions the men remained friends. Pitt later joined NASA and its Solar Shuttle Project (an orbital power station). Pitt discovered two traumatic things-his wife was dying of a terminal disease and Latverian spies had infiltrated the project. Unable to solve his wife's problem, he decided to destroy the spy network from within. He posed as a collaborator but did not tell his superiors what he was up to. Pitt was so valuable to the spies that Doom even learned of his work. Unfortunately, Mrs. Pitt died and the major got careless in his grief. His double-agent activity was discovered by the other spies; higher placed opera-

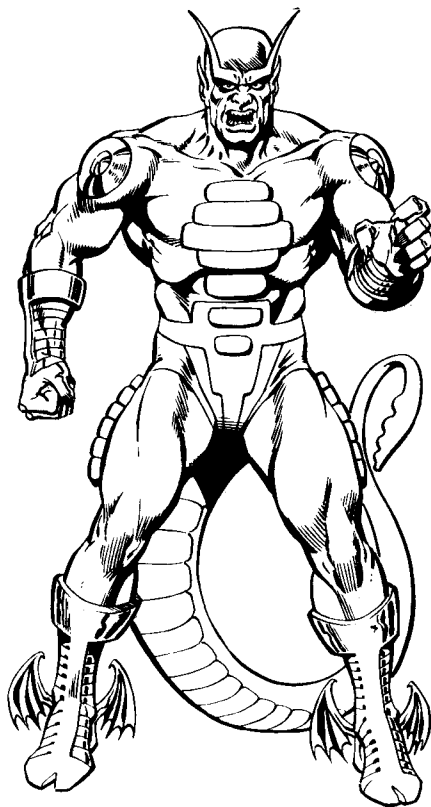

tives within NASA denounced Pitt as a traitor, then secretly seized him and brought him to Latveria. The U.S. government assumed he'd been killed by his co-conspirators.

In fact Doom decided to make an example of Pitt. Pitt was subjected to several months of chemically induced mutation. As the final step, Doom erased Pitt's memory and gave him a new one as Darkoth, a demon summoned to act as Doom's personal warrior. Darkoth was sent to capture the FF, which he did. With the idea that the truth would drive Pitt mad, Doom then told Darkoth his real identity. Darkoth went berserk, freed the FF, and pursued Doom onto his space shuttle. In a battle in space, Darkoth destroyed the ship. He plunged into the atmosphere and crashed in the Texas desert.

Diablo witnessed the fiery descent and rescued the dying Darkoth. As he healed Darkoth, he learned that Darkoth and he had a common enemy in Doom. Diablo decided to use Darkoth to destroy Doom. He gave Darkoth the powers of flight and Phasing, as well as sapping Darkoth's will. However, when Darkoth discovered that Diablo's plans included killing Ben, he rebelled and regained his will. In a

pitched battle, Darkoth threw himself and Diablo into a mass of exploding equipment. Darkoth died.

**RUNNING DARKOTH:** As Pitt, he was a career pilot. As Darkoth, he was a raging berserker. When he regained his memory, he became obsessed with destroying Doom.

## DIABLO

Esteban Diablo a.k.a. "Mr. Olbald"

F	GD	(10)	Health: 32
A	TY	(6)	
S	TY	(6)	Karma: 66
E	GD	(10)	
R	RM	(30)	Resources: GD(10)
I	TY	(6)	
P	EX	(20)	Popularity: -10

### KNOWN POWERS:

*Alchemical Magic:* Diablo's powers are all derived from arcane compounds. The compounds have different forms and manners of use. Forms include gases, smokes, liquids, powder, and tablets. The potions may be consumed by Diablo or his intended victim, administered externally, thrown at the ground for an area affect, or thrown at the target for a specific effect. Diablo has troves of premade potions stashed throughout the world. He carries the formulae in his head and can easily duplicate any formula if he has the proper ingredients. Normally he carries 4-40 potions hidden in various pockets in his costume. As a last resort, he keeps his Regeneration potion soaked into his moustache.

*Neural Manipulation (Paralysis):* This exploding tablet releases a paralytic gas of Excellent effect over two areas.

*Body Transformation (Protoplasm):* This Incredible potion transforms whoever drinks it into a mass of protoplasm. The person's consciousness and lifeforce remain unaffected. While in this form, a person is immune to energy attacks and takes only half damage from physical attacks.

*Emotion Control:* This Excellent potion must be drunk by the victim. Once this is done, that person feels whatever emotions Diablo desires.

*Explosives:* These are nonmagical explosives that are thrown as miniature grenades; Diablo can throw them 1 area. They do Incredible damage.



**Immortality:** Diablo needs to drink this potion annually to maintain the appearance and health of a man in his 30s.

**Imitation:** This Remarkable potion enables the drinker to transform his appearance to that of any other person.

**Iron Will:** This potion gives the drinker Incredible control over his own body. He can even postpone dying while under this potion's effects.

**Lifeform Creation:** This Unearthly potion has the ability to transform inanimate matter into living flesh. It must be poured into an existing object. It does not change the external appearance of the original matter but it does change the interior into functional organs and bodily fluids.

**Matter Animation (all forms):** This Remarkable potion brings to life whatever it is poured over or mixed with. If used on a corpse, it produces a zombie.

**Mind Control:** This exploding tablet gives him Remarkable control over the conscious mind of whoever breathes its fumes.

**Molding:** This Amazing potion can be mixed with the Molecular Conversion potion to reshape whatever it is poured over.

**Molecular Conversion:** This Amazing potion transmutes the chemical nature of whatever it is poured over. The basic formula can be infinitely varied to produce specific effects. In game terms, Players or Judges must write down beforehand what particular effect each sample might produce.

**"Nature Control":** This potion gives the drinker Incredible control over one of the four "Elements"—Earth, Water, Air, and Fire. Only one of the potions can be used at one time, unless they are used to animate an Elemental golem.

**Regeneration:** This Remarkable potion can cure any injury or illness suffered by whoever consumes it.

**Sleep (Induced):** This volatile potion has the Incredible ability to knock out whoever drinks it or inhales its fumes.

**Suspended Animation:** This potion places whoever drinks it in a Remarkable trance.

**TALENTS:** Diablo is the world's foremost expert on Alchemical Magic. He also gains +2CS with thrown objects due to his centuries of practice throwing vials at people.

**CONTACTS:** None.

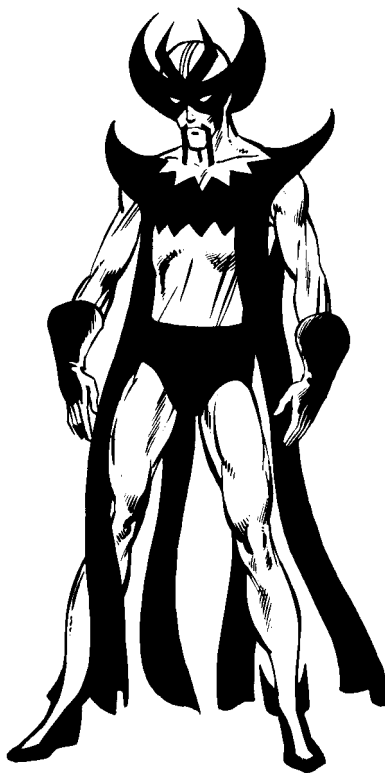

**BACKGROUND:** Esteban Diablo was born in 9th century Spain, the son of a nobleman. He developed an intense interest in Alchemy and roamed Medieval Europe seeking knowledge. Within a decade, he had learned and exceeded all the known Alchemical practices. In Transylvania he established a laboratory in a castle he acquired through questionable means. Diablo's reign of terror ended when a mob of enraged peasants trapped him in a crypt in his own castle. There he remained for 1000 years.

The FF were vacationing in Transylvania and chanced to stay in Diablo's castle. As Ben slept, Diablo gained control of his mind and commanded him to break open the crypt. Diablo then embarked upon a plan of world conquest. The FF and others have always defeated his schemes.

Recently he decided he needed allies under his direct control. He noticed that the FF's powers all corresponded in some way to the four "natural elements." He fashioned four "Primal Elementals" and set them to defeat the FF. Unfortunately, while the Primal Elementals proved they could probably kill most of the FF's members, they were defeated

by their opposing number in the FF. When Crystal joined the new FF, he added another golem, the Transmutant, to counter her powers. The plan almost worked until Ms. Marvel (II) showed Diablo the Primal Elementals' one weakness—they cease to exist if Diablo loses consciousness.

**RUNNING DIABLO:** Diablo enjoys causing panic and destruction. He wants to conquer the world but since he has a limited budget, he must work slowly.

## AIR ELEMENTAL

F	RM	(30)	Health:100
A	GD	(10)	
S	RM	(30)	Karma: 10
E	RM	(30)	
R	TY	(6)	
I	FE	(2)	
P	FE	(2)	

### KNOWN POWERS:

*Air Animation:* Incredible rank.

*Whirlwind:* Incredible rank.

**WEAKNESS:** It exists only as long as Diablo remains conscious.

## WATER ELEMENTAL

F	RM	(30)	Health:100
A	GD	(10)	
S	RM	(30)	Karma: 10
E	RM	(30)	
R	TY	(6)	
I	FE	(2)	
P	FE	(2)	

### KNOWN POWERS:

*Water Animation:* Incredible Rank

**WEAKNESS:** It exists only as long as Diablo remains conscious.

## EARTH ELEMENTAL

F	RM	(30)	Health: 145
A	GD	(10)	
S	MN	(75)	Karma: 10
E	RM	(30)	
R	TY	(6)	
I	FE	(2)	
P	FE	(2)	

### KNOWN POWERS:

*Earth Animation:* Incredible rank.

*True Invulnerability:* Remarkable rank.

**WEAKNESS:** It exists only as long as Diablo remains conscious.

### FIRE ELEMENTAL

F	RM	(30)	Health: 100
A	GD	(10)	
S	RM	(30)	Karma: 10
E	RM	(30)	
R	TY	(6)	
I	FE	(2)	
P	FE	(2)	

### KNOWN POWERS:

*Energy Body (Flame):* Remarkable rank.

*Fire Control:* Remarkable rank.

*Fire Generation:* Remarkable rank.

*True Flight:* Remarkable speed.

**WEAKNESS:** It exists only as long as Diablo remains conscious.

### TRANSMUTANT

F	RM	(30)	Health: 100
A	GD	(10)	
S	RM	(30)	Karma: 10
E	RM	(30)	
R	TY	(6)	
I	FE	(2)	
P	FE	(2)	

### KNOWN POWERS:

*Molecular Conversion:* Incredible rank but limited to Contact-only range.

**WEAKNESS:** The Transmutant exists only as long as Diablo remains conscious.

### DOCTOR SUN

F	EX	(20)	Health: 100
A	EX	(20)	
S	RM	(30)	Karma: 135
E	RM	(30)	
R	IN	(40)	Resources: EX(20)
I	EX	(20)	
P	MN	(75)	Popularity: 0

### KNOWN POWERS:

*Cyborg (Mechanical Body):* The only human parts of Dr. Sun are his brain and spinal cord. These are enclosed in a

plasma-filled life support system. The system has Monstrous Material Strength. The original system was immobile and possessed only the abilities to see, hear, and speak. During this period Dr. Sun's Fighting, Agility, and Strength ranks were all Shift-0. Later Dr. Sun fitted himself to a robotic body that provided him with mobility, increased Abilities, and some powers. Should Dr. Sun have ever been without his robotic body, his Health would drop to 30.

*Bio-Vampirism:* (This power only applied to Dr. Sun when he still possessed his original brain.) Dr. Sun was dependent on a fresh supply of human blood and plasma to maintain his life support system. He needed new blood every 75 hours to keep his brain alive.

*Body Armor:* Sun's braincase has Monstrous material strength. His robotic body possesses Amazing material strength.

*Mind Transferral:* Sun has the ability to transfer his consciousness and lifeforce into any computer of at least Incredible Reasoning capability.

*Mind Control:* Dr. Sun has the Monstrous ability to control people's conscious thoughts and actions.

*Kinetic Bolt:* The robot's hands are equipped with devices that fired bolts of Remarkable Intensity.

*Linguistics:* Dr. Sun is able to understand any language, especially computer codes, with Remarkable ease.

*Teleportation:* The robot body is equipped with a teleportational device of Monstrous range.

**TALENTS:** Dr. Sun is a brilliant inventor and medical technician.

**CONTACTS:** None.

**BACKGROUND:** Dr. Sun was a scientist working in the People's Republic of China during the Cultural Revolution. Sun devised a program whereby a human brain could be removed from its body and supported indefinitely in a life support system. A political enemy managed to sentence Sun to death, then decided Sun should be the test subject of his own program.

The initial operation succeeded better than expected. When Sun's mind was connected to a computer bank, he suddenly developed psionic powers. He attacked the doctors, then forced the survivors to serve him. He kept his survival and powers a secret from the Chi-

nese government and eventually left China completely.

Because of his dependence on human blood, Dr. Sun became involved with the study of real vampires. He decided that a vampiric army could serve him and conquer the world, but first he needed to conquer the vampires. He fought Dracula a number of times, drained most of Dracula's powers, and even managed to "kill" him once.

After Dracula defeated his plans, Dr. Sun switched tactics. He discovered Nova (1)'s link to the supercomputers of Xandar. He captured Nova and intended to plug into the computers from Earth. When the Sphinx commandeered Nova's ship directly to Xandar, Sun abandoned his body and invaded the Xandarian computers directly. When the FF later arrived with H.E.R.B.I.E. in tow, Sun downloaded into that robot's body. Upon returning to Earth, he tried to destroy the FF by turning their headquarters against them. He took possession of the Baxter Building's computer system. This freed H.E.R.B.I.E., who flew into the computer bank where Sun was isolated. Dr. Sun was finally destroyed in the resultant explosion.

**RUNNING DOCTOR SUN:** Dr. Sun was a ruthless scientist and would-be conqueror. When he lost his body, he also lost any identification with the human race.

### DRAGON MAN

F	GD	(10)	Health: 145
A	GD	(10)	
S	AM	(50)	Karma: 8
E	MN	(75)	
R	FE	(2)	Resources: none
I	FE	(2)	
P	PR	(4)	Popularity: 0

### KNOWN POWERS:

*Android:* Dragon Man is an Android created by Prof. Gilbert and given life by Diablo.

*Extra Body Parts (Tail):* His tail can be used as a weapon to attack foes behind him.

*Fire Emission:* Dragon Man can exhale a Monstrous Intensity blast of fire. The maximum range for the blast is two areas. He can only emit 20-25 such blasts before he needs to refuel.

*Flight:* Dragon Man's wings and an inter-

nal anti-gravity device combine to give him Good speed (60 mph).

**Armor Skin:** His leathery hide gives him Incredible resistance to physical and energy attacks.

**WEAKNESS:** Energy (Sonics): The Dragon Man undergoes startling mood changes if he is subjected to certain frequencies of ultrasonic sound. Depending on the frequency, the Dragon Man may become enraged, determined, confused, or docile. In game terms, he must make a Psyche FEAT each round that he is subjected to the sounds. The mood shift occurs when he fails; if the frequency changes, he must make a new FEAT or shift again, and so on.

**TALENTS:** None whatsoever, despite Prof. Gilbert's attempts to teach him.

**CONTACTS:** Dragon Man is the creation of Prof. Gilbert of State University, who remains devoted to his creation.

**BACKGROUND:** Professor Gregson Gilbert is a researcher studying the effects of super-powers. To help his research he decided to build an android that would presumably be more powerful than the FF. To this end he constructed a 15-foot tall, three ton anthropoid dragon. Unfortunately he had no way of bringing his creature to life. When Diablo learned of Gilbert's creation he provided an elixir that transformed the Dragon Man statue into a living being. Diablo soon discovered the Dragon Man possessed an uncontrollable will of his own, a fact discovered by several villains who later tried to use the creature for their own ends. Dragon Man was finally returned to Prof. Gilbert, who is caring for him and finally putting him to his original academic purpose.

**RUNNING DRAGON MAN:** Dragon Man's personality is essentially that of a child. His behavior matches that of a two-year-old, assuming the tyke had Dragon Man's body and powers. He likes to play, especially with dolls or pets (it's unknown which category people fit into). It is only when he throws a tantrum or falls under someone's influence that Dragon Man acts like a villain.



## ELIMINATOR

F	RM	(30)	Health: 90
A	GD	(10)	
S	RM	(30)	Karma: 12
E	EX	(20)	
R	TY	(6)	Resources: N/A
I	PR	(4)	
P	FE	(2)	Popularity: -10

### KNOWN POWERS:

**Cyborg Body:** The Eliminators appear to be ten-foot-tall bald men in red armor. In truth the bulk of the Eliminator's body, particularly the limbs and skeleton, have been replaced by mechanical parts and internal weapons systems.

**Body Armor:** The Eliminator possesses a metallic skin of Monstrous Material Strength.

**Fire Generation:** Fingertip jets can emit blast of Remarkable intensity.

**Magnetism:** The Eliminator is equipped with a tractor beam of Monstrous rank. As a Power Stunt, the Eliminator can trigger an internal overload of this power that creates a blast of Unearthly intensity. This destroys the Eliminator and does power rank damage to anything within a single area.

**Hyper-breath:** Vacuum vents built into his boots have the Amazing ability to suddenly remove all the air in a target area. This can be developed into Power Stunts such as:

- Extinguishing flames of up to Amazing intensity.
- Creating small windstorms of Amazing intensity.

**"Omni Beam":** This Remarkable power is actually the simultaneous use of Plasma Generation and Mind Blast. The Omni Beam is fired from the Eliminator's forehead.

**Life Detection:** The Eliminator has Poor range (1 area).

**Vehicle:** The Eliminator is equipped with an egg-shaped flier with Remarkable airspeed. The flier has Excellent Material strength.

**TALENTS:** None.

**CONTACTS:** The Eliminators were created by the New Salem Witches, but since the Eliminators were only tools, it is unlikely the New Salemites would have assisted the creations.

**BACKGROUND:** The Eliminators were warrior cyborgs created by the New Salem Witches. Each was created for a specific purpose. For example, the first one fought by the FF had been assigned to destroy all traces that Agatha Harkness had ever dwelt in the outside world. This mission included the destruction of Whisper Hill and the deaths of the FF. Once an Eliminator's mission was accomplished, it was programmed to destroy itself.

**RUNNING AN ELIMINATOR:** Eliminators were monomaniacal berserkers. When beginning a mission they operated secretly; an Eliminator would only reveal its existence when either the mission was completed or the Eliminator felt he had a safe position to do so.

## EGO, THE LIVING PLANET

F	CL1000	Health: 6502
A	FE (2)	
S	Z (500)	Karma: 800
E	CL5000	
R	X (150)	Resources: N.A.
I	X (150)	
P	Z (500)	Popularity: 0



### KNOWN POWERS:

*Sidereal Propulsion Unit:* this device was created by Galactus to propel Ego at CL1000 speed into the intergalactic void. Ego has since discovered how to control the unit.

*Absorption Power:* Ego has the CL1000 ability to feed on stellar energy or the lifeforces of masses of beings.

*Shape Change:* Ego has the Unearthly ability to transform any part of its surface or interior. This enables Ego to create surface features, attack intruders, and so on. It can be used to create such Power Stunts as:

- Create attacking tendrils up to 100 miles long that do Unearthly damage if they hit a target.
- Create "humanoids" from its surface. These can travel independently of Ego but remain under his control.

*Clairvoyance:* Ego has Shift-Z ability to probe either deep space or his own interior.

*Gravity Control:* Ego can use his own gravity to attack other worlds with CL1000 damage.

*Kinetic Blast:* Ego can emit CL1000 blasts.

*Mind Blast:* Ego can emit blasts of CL1000 rank.

*Power Transferal:* Ego can instill portions of his powers in the beings he creates from his body. The Powers have ranks from Feeble to Unearthly.

*Regeneration:* If Ego is dispersed, he can regather his mass and reform his planetary body.

*Telepathy:* Ego has Shift-Y rank.

**TALENTS:** Ego has Astro-Navigational skill.

**CONTACTS:** None.

**BACKGROUND:** Ego is a unique being, a planet that attained life and self-awareness without being first infused with the lifeforce of an Entity. Ego appears to be a luna-sized planet made into a caricature of a bearded man's head. He was born in the "Dark Galaxy," an opaque nebula somewhere near the Milky Way. Ego decided to conquer the galaxy by sending forth super-powered beings formed from Ego's own matter. Thor put an end to this when he created a planetwide storm that stunned Ego. Ego renounced his plans for conquest. When Galactus attacked Ego months later, Thor returned to help Ego drive off the world-devourer.

Ego went mad after a portion of his mass was removed and formed into a short-lived being called Ego-Prime. Ego battled Thor, Firelord, Galactus, and Hercules before Galactus attached the sidereal propulsion unit that sent Ego careening into the intergalactic void.

A year later, Ego had mastered the unit's controls and set off in pursuit of Galactus. His first stop was Earth, which he almost destroyed as he approached too closely. The FF invaded Ego and managed to disable one of the two engines. When Ego activated the remaining engine, he sailed into the sun and almost perished. He is currently conspiring to destroy Galactus with the other Elders of the Universe.

**RUNNING EGO:** Ego is concerned with only two things. First, he must protect himself. The second concern is the destruction of Galactus, the only creature in the universe older and perhaps more mighty than the Elders.

Ego can be friendly and cooperative with smaller life but it will turn on those people when they no longer serve Ego's needs.

### GORMU

F	RM	(30)	Health: 290
A	GD	(10)	
S	UN	(100)	Karma: 30
E	X	(150)	
R	GD	(10)	Resources: N/A
I	GD	(10)	
P	GD	(10)	Popularity: -50

### KNOWN POWERS:

*Absorption Power:* Gormuu has the Shift-Z ability to transform any energy into personal power. This gained energy is automatically transferred to his Growth power on a point for point basis. The power absorbs any intensity of energy; however, only intensities above Good can fuel his Growth power.

*Growth (Atomic Dispersal):* Gormuu has the ability to rapidly increase in size by increasing the distance between his atoms and subatomic particles. This power works exponentially at a Good rank. That is, each time he grows he expands to four times his previous size. This leads to an accelerating cycle in which Gormuu can grow to any arbitrarily large size (which is precisely what happened). Gormuu can shrink at a similar

rate if he is no longer absorbing energy through his Absorption Power. Because Gormuu is only inflating in size, his mass, Fighting, and Strength ranks do not increase. He does become an easier target, which is desirable for him since being attacked in turn fuels his Growth cycle.

**TALENTS:** unknown.

**CONTACTS:** unknown.

**BACKGROUND:** Although other aliens had landed on Earth in the distant past, Gormuu was the first to attempt to conquer it in recent history. He landed his saucer outside Central City, California, and immediately announced his intentions to the first humans he met. In this case, it was Reed and Sue, who were horrified to realize that Gormuu had come to conquer Earth. Gormuu laughed and trudged off to wreak havoc. As Central City's leading scientist, Reed assisted in the defense against Gormuu. When the Soviets delayed the US' use of nuclear weapons against Gormuu, Reed hurried off to Gormuu's ship in hopes of finding a method to stop him.

Reed recognized that Gormuu's spartan ship was filled with energy relays. He also noticed that the depths of Gormuu's footprints did not increase as he grew. Reed hit upon a desperate plan. He built an energy relay of his own and aimed it at Gormuu. The invader welcomed the additional power at first; then he realized that he was growing intangible. The last the Earth saw of Gormuu was a green nebula that quickly faded from sight.

Gormuu had a lasting effect on Reed, who realized that not all spacefaring races were friendly. This drove his ambition to perfect his starship and led directly to its fateful voyage.

**RUNNING GORMUU:** Gormuu is a world-conqueror. It is unknown what Gormuu intended to do had he succeeded. It is also unknown if Gormuu acted independently or if he was sent to Earth by unsuspected forces.

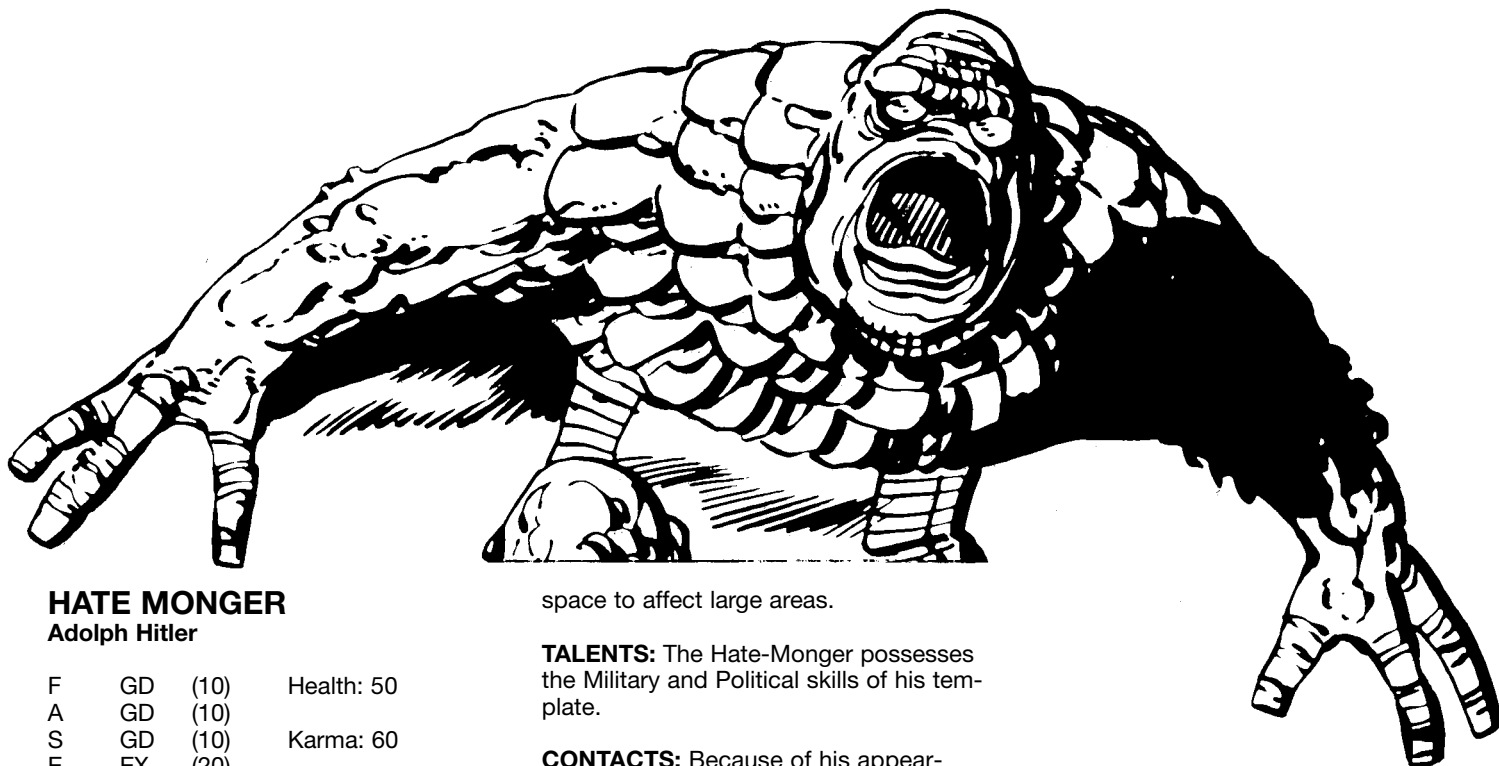

## HATE MONGER

Adolph Hitler

F	GD	(10)	Health: 50
A	GD	(10)	
S	GD	(10)	Karma: 60
E	EX	(20)	
R	GD	(10)	Resources: EX(20)
I	GD	(10)	
P	IN	(40)	Popularity: -30

### KNOWN POWERS:

*Serial Immortality (Premade):* The Hate Monger is the name for a series of clones of Adolph Hitler. The basic clone is a disembodied brain that supposedly houses Hitler's intellect and personality. The brain is able to transfer its personality to any of the previously grown Hitler clone bodies. If the currently active body is killed, the Hitler mentality returns first to the main brain, then later to a whole body.

*Emotion Control (Hatred):* The villain's Hate-Ray has the Monstrous rank ability to inflame people's emotions to pure hatred. It operates by bombarding a person with special high-frequency microwaves that directly affect the areas of the human brain that control emotion. The victim experiences unusually high dread, fear, and anger which crystallizes around some latent hostility the victim already possesses. The H-ray can also specifically reverse love into devastating hatred. The H-ray can be built into a pistol for aiming at a single person or small group or it can be built into a cannon-like device that can be fired from

space to affect large areas.

**TALENTS:** The Hate-Monger possesses the Military and Political skills of his template.

**CONTACTS:** Because of his appearance, the Hate-Monger can call on any neo-Nazi organization in the world.

**BACKGROUND:** In the closing days of WWII, Nazi scientist Arnim Zola perfected the techniques for both cloning and transferring a person's consciousness into another, distant body. An intrigued Hitler allowed Zola to use the techniques on him. When the first Human Torch incinerated Hitler in 1945, the Fuhrer's mind was transferred into a waiting cloned brain.

Over the years, Zola experimented on the brain and grew several clone bodies with Hitler's DNA. Zola treated the brain and bodies in order that one's mental essence could be freely transferred to another. Finally, the time came to act. The clone took the masked identity of the Hate-Monger; he reasoned that by inflaming the hatred of the free world against itself, he could destroy it. The Hate-Monger began to operate on several fronts. In the U.S. he began to openly preach civil strife and test his small-scale H-ray. He simultaneously tested his large scale equipment in the civil-war-torn country of San Gusto. The original Hate-Monger was defeated by the FF with the help of Nick Fury and slain by his own men. There were at

least six later Hate-Mongers, including a headless android whose brain Zola intended to transplant into Captain America's body. All the clones died nasty deaths.

The Hate-Monger's short-lived alliance with the Red Skull proved his undoing. Together they had constructed their own Cosmic Cube. The Red Skull convinced the Hate-Monger that the cube could house his intellect and give him greater power. He lied. The mind of the Hate-Monger is now apparently trapped in that cube, in an unknown location.

**RUNNING THE HATE-MONGER:** The Hate-Monger wants to conquer the world by making the nations of the Earth tear themselves apart. He is a ruthless madman who will sacrifice his entire forces and even his body to achieve his ends.



## HATE-MONGER III

H. M. Unger

F	TY	(6)	Health: 18
A	TY	(6)	
S	TY	(6)	Karma: 95
E	GD	(10)	
R	GD	(10)	Resources: EX (20)
I	GD	(10)	
P	MN	(75)	Popularity: Special

### KNOWN POWERS:

*Android Body:* Hate-Monger is an android built by the Psycho-Man to conquer Earth.

*Imitation:* His body is designed to duplicate the appearance of any normal human, whether male or female. He is unable to duplicate another's powers, nor can he take the form of extremely altered people, such as the Thing.

*Emotion Control:* The Hate-Monger has an internal version of the Psycho-Man's Control Box. He has the Amazing rank ability to distort people's thinking and make them feel intense hatred against anyone he chooses; however, this only works at close range (2 areas). If he can touch his victim, his power increases to Uearthly rank. The initial hate-effect lasts for 1-10 hours.

*Pamphlets:* To further his reach, the Hate-Monger has distributed pamphlets tainted with mind-altering chemicals. These act on contact to attack the victim with Remarkable Emotion Control. The pre-programmed effect is usually a magnification of some minor irritation or subtle prejudice. The effect lasts for 1-10 hours after the last contact with the pamphlet. Each pamphlet can function 10-100 times. Note that the chemicals in the pamphlet must make direct skin contact.

**TALENTS:** The Hate-Monger has Psychiatric Skills that enable him to effectively nurture and direct a victim's hatred.

**CONTACTS:** The Hate-Monger has one lasting contact in his creator, Psycho-Man. He can also control any group favorable to his given appearance at the time; for example, white supremacists would assist his blond, blue-eyed H. M. Unger self.

**BACKGROUND:** Psycho-Man created the android H. M. Unger (say the name aloud) as his tool to conquer Earth. He equipped Unger with the ability to spread hatred through mind control and the shapeshifting ability to appear favorably to any given group of victims. Psycho-Man then accompanied his creation to New York, although he remained in the shadows himself. Unger was able to inflame most of the city and even bring Sue Richards under his control as the villainess, Malice. Reed was able to counteract Unger's mind controls, first over Sue, then over the rest of the city. As his power waned, Unger was assaulted by the mysterious vigilante, Scourge.

**RUNNING HATE-MONGER III:** Unger is a lying, duplicitous fiend who can amplify anyone's pet peeve into an unholy crusade. He is subservient, even afraid, of his master, the Psycho-Man.

## MEPHISTO

a.k.a. Satan, Mephistopheles, Lucifer, Beelzebub, and "The Devil"

F	MN	(75)	Health: 3225
A	MN	(75)	
S	MN	(75)	Karma: 250
E	CL	3000	
R	MN	(75)	Resources: CL3000
I	MN	(75)	
P	UN	(100)	Popularity: -1000



### KNOWN POWERS:

*Demonic Form:* Mephisto is a hostile supernatural being.

*Power Source:* Mephisto derives his powers from his pocket dimension of Limbo. If he is away from Limbo, his Endurance drops to CL1000.

*Dimension Travel:* Uearthly rank.

*Diminution (Atomic Shrinkage):* Uearthly rank.

*Enchantment:* Mephisto has the Shift-Z ability to create magical items, usually for the use of his minions.

*Enlargement (Atomic Growth):* Uearthly rank.

*Forced Reincarnation:* Mephisto has the Uearthly ability to take a disembodied soul and place it into a new body.

*Immortality:* Mephisto does not age, at least not at a rate humans can recognize.

*Invisibility (all types):* Uearthly rank.

*Kinetic Bolts:* Mephisto can fire blasts of Monstrous rank.

*Levitation:* Uearthly rank.

*Magic Control:* He has Uearthly control over any magic anyone tries to use in his realm.

*Matter Control (all forms):* Uearthly rank.

*Neural Manipulation:* He has Uearthly control over victims' nervous systems



and can cause up to power rank damage.

*Power Control:* He has Uearthly control over any physical powers anyone else tries to use in his dimension.

*Shapechange Others:* He can do this with Uearthly rank.

*Shrinking (Atomic Shrinkage):* Uearthly rank.

*Sleep (Induced):* Uearthly rank.

*Spirit Storage:* He has the CL5000 ability to seize and hold indefinitely millions of souls.

*Summoning:* He has Uearthly control over lesser supernatural beings.

*Gateway:* Uearthly rank.

True Invulnerability. He has Amazing protection from any attack except Magic.

*Undead Control:* He has Uearthly control over the lower forms of the undead (skeletons and zombies, mostly).

**WEAKNESSES:** There are two things he can never do. First, he can not read the minds of any sentient being. Second, he can not control another being without that being's prior permission.

**TALENTS:** Mephisto has all the Occult Lore you can imagine.

**CONTACTS:** (are you kidding?)

**BACKGROUND:** Mephisto is a real, bona fide demon, an Entity of great power who has been corrupted with time. He dwells in a home dimension that resembles the Judeo-Christian concept of "Hell" and maintains the illusion that he is that religion's supreme evil being. He is not, but he finds the charade useful in his eternal search for souls to corrupt.

It is unknown what Mephisto does with the souls he collects. He prefers human ones, though he has repeatedly tried to take the Silver Surfer's soul. He possessed Shalla Bal's soul and reincarnated it as an Earth woman. He also possesses the soul of Cynthia von Doom, Dr. Doom's mother. Dr. Doom is constantly seeking ways to free his mother. One method was to trade Franklin Richards for her. That plan failed when Franklin defeated Mephisto (again).

**RUNNING MEPHISTO:** Mephisto has three main goals—collect souls, control people, and instill fear. He uses people's preconceived ideas of demonic behavior to further his goals. After losing two battles with Franklin Richards, Mephisto

now holds a special grudge against the boy.

## MIRACLE MAN

F	PR	(4)	Health: 26
A	GD	(10)	
S	TY	(6)	Karma: 160
E	TY	(6)	
R	RM	(30)	Resources: PR (4)
I	RM	(30)	
P	UN	(100)	Popularity: 30

### KNOWN POWERS:

*Hypnotic Control:* Miracle Man possessed Uearthly powers of hypnosis and suggestion. The power enabled him to achieve control without verbal commands. The power could affect anyone who made eye contact with him, even if the victim was only watching Miracle Man over a television monitor. He developed his Power in ways that mimicked other powers:

- *Animate Image:* He could bring existing images to apparent life. The "real" images could inflict psychosomatic injury on their victims.
- *Invisibility (Telepathic):* He could become effectively invisible by making people ignore his existence.
- *Illusory Duplication:* He could make decoys of himself.

The following powers were taught him by the Cheemuzwa Tribe:

*Hyper-Strength:* Amazing rank.

*Kinetic Bolt:* Amazing rank.

*Lifeform Creation (Androids):* Amazing rank

*Matter Animation (Solids):* Amazing rank.

*Power Transferral:* He could invest his androids with his powers.

Note: as a side-effect, he gained the power of Hard Radiation Control. His Amazing rank causes the radioactivity of any nuclear material within 50 miles to increase + 1 CS for each hour he used his powers. When he sleeps, the radioactivity automatically returns to normal.

**TALENTS:** He is a barely adequate stage magician and hypnotist.

**CONTACTS:** None.

**BACKGROUND:** The Miracle Man began his career as a cheap stage magician. He wasn't very good but he discovered he was subconsciously hypnotizing his audience into "seeing" him perform



incredible tricks. One night he saw the then-new FF sitting in the audience; he boasted his powers were greater than theirs and apparently proved it when he humiliated the Thing onstage. That night he decided it was time he used his powers to get really rich as a super-criminal. His career came to a screeching halt when Reed deduced that the Miracle Man's powers were all illusions. A burst of light from the Human Torch blinded him and destroyed his powers.

Eventually his vision returned but not his original powers. He sought training from the Cheemuzwa Tribe, a group of Amerindian psychics. They gave him psionic powers that he used to apparently destroy the surviving tribe members. He then tried to destroy Wyatt Wingfoot's tribe but was defeated by the timely arrival of Wyatt, the Torch, the Thing, and Medusa. The Cheemuzwa reappeared, explained they had really been ghosts all along, and took Miracle Man away to another plane where they tried to teach him to use his powers properly. He escaped once and returned to wreak havoc before he was defeated

by the Thing. The Cheemuzwa destroyed his powers and gave him amnesia.

He joined a monastery. There he encountered Daimon Hellstrom and somehow gained the latter's Darksoul. This restored his mind and all his powers. Another brief rampage followed before the Darksoul left his body. Miracle Man finally lost his Cheemuzwa-taught powers but he retained his original hypnotic power.

Several months later he decided he needed an ally and attempted to free the Rhino, who was en route to the Pegasus Project for treatment. Coincidentally, the Thing was on the same bus the impoverished Miracle Man was riding. The hypnotized Rhino fought the Thing but turned on Miracle Man when the latter's hypnosis was revealed. Miracle Man was fleeing the scene when he was killed by another bus passenger, Scourge.

**RUNNING MIRACLE MAN:** He was an egotist who wanted the world to acknowledge his greatness and power. If he didn't have enough power to command the world's attention, then he set out to gain more.

## MOLE MAN

F	GD	(10)	Health: 54
A	PR	(4)	
S	GD	(10)	Karma: 70
E	RM	(30)	
R	RM	(30)	Resources: IN (40)
I	GD	(10)	
P	RM	(30)	Popularity: 0 (100 to Moloid Subterraneans)

### KNOWN POWERS:

**Abnormal Sensitivity:** Mole Man's eyes are extremely sensitive to light. He is virtually blinded by normal illumination.

To counter this, he wears protective glasses that both reduce bright light to levels he can tolerate and increase dim light to levels by which he can see.

**Hyper-Hearing:** Mole Man has Typical hearing that enables him to find his way around in the unlit depths of the earth.

**Hyper-Touch:** Mole Man has Typical sensitivity and can identify things by touching their surface if he succeeds in a green Reason FEAT.

**Weapon Staves:** Mole Man has a series of similar-looking staves (6 ft. long, made of wood or aluminum) which contain a



weapon and additional features. All staves include a galvanic response meter that is tuned to the Mole Man's body; this prevents anyone else from activating his staves.

**Radar:** All staves contain the Good ability to electronically map out the surroundings. The information is relayed as a series of braille dots.

**Electrical Generation:** Incredible rank.

**Fire Generation:** Remarkable rank.

**Light Emission (Laser):** Incredible rank.

**Vibration:** Incredible rank.

**TALENTS:** Mole Man's life has made him an expert on subterranean geography, spelunking, understanding Deviant weapons systems, and monster training.

**CONTACTS:** He was once an ally of the Red Ghost and Kala, leader of the Outcasts.

**BACKGROUND:** Little is known of Mole Man's past, save that he was shunned by the world because of his homeliness. While wandering the forgotten areas of the world, he discovered Monster Island in the Bermuda Triangle and the island's cavernous entrance to Subterranea. There he mastered the branch of Subterraneans now called the Moloids. He used the creatures and technology he found there to strike back at the outer world. Later he reformed and began to concentrate on building a sanctuary for other

people rejected by the surface world. Tragically his two attempts thus far have led to the death of most of the visitors to his sanctuaries. When we last saw the Mole Man, he had constructed elaborate holographic fantasies, and was proceeding towards insanity.

**RUNNING THE MOLE MAN:** Mole Man's original motivation was revenge against the outside world, which he felt rejected him. Then he mellowed and concentrated on defending his Moloids against invaders. He has great sympathy for other people rejected by society, especially the old and deformed.

## MOLECULE MAN

Owen Reece

F	FE	(2)	Health: 20
A	PR	(4)	
S	PR	(4)	Karma: 89
E	GD	(10)	
R	GD	(10)	Resources: EX (20)
I	FE	(2)	
P	MN	(75)	Popularity: 1

### KNOWN POWERS:

**Elemental Conversion:** He has the Unearthly ability to transform any element into any other element.

**Molecular Conversion:** He has the Monstrous ability to transform any element or compound into any other element or compound.

**Matter Animation:** He has the Monstrous ability to give independent motion to any solid matter. He has developed this into various Power Stunts including:

- **Flight**—He can attain Poor airspeed (60 mph) by riding along on something he is animating. He often travels on a single bed with a brass headboard.
- **Machine Animation**—Owen can control any mechanical device simply by controlling its basic materials.

**Molding:** He can form matter into anything he can imagine at Monstrous rank. Unfortunately, his imagination is severely limited.

**Disruption:** He has the CL3000 ability to cause matter to break apart into fragments or even individual atoms.

**Serial Immortality (Parasite/Merger and Spontaneous Creation forms):** When he was dying of old age in another dimension, Owen transferred his powers and life force into his tool, an ordinary iron bar. When the bar was possessed by

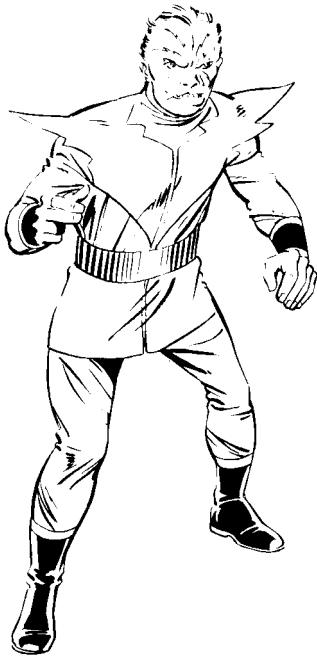

another person, Owen could take over that body by merging his personality with that of his victim. The victim also developed the nine lightning-strokes on his face. Later, Owen discovered he could build a fairly accurate facsimile of his lost body.

**WEAKNESS:** Normally, none of his powers works on any living target. The only way he can affect such a person is to control the matter that surrounds that person. Presumably his powers might work on a corpse but Owen is too sensitive a soul to try such a disgusting experiment. The sole exception to this limitation is that Owen is able to create living tissue to form a new body for himself.

**TALENTS:** None.

**CONTACTS:** None.

**BACKGROUND:** Owen Reece was a minor technician at the Acme Atomic Corporation when he accidentally activated an experimental device and bombarded himself with unknown energy. This transformed his body and gave him his new powers. He promptly set about to terrorize NYC and was swiftly defeated by the FF when he discovered his powers didn't work on living tissue.

Uatu the Watcher transported him to another dimension where time passed swiftly. In boredom Owen created a

“son” who had his powers and could even affect living matter. The son returned to the Earth dimension and battled the FF in order to avenge his father. When the FF took the iron bar away from him, the son lost his powers and disintegrated.

Owen then proceeded to take over a series of bodies as three people came in possession of the iron bar—a young girl named Cynthia McClellan, a boxer named Aaron Stankey, and Reed Richards himself. Following the link with Reed, Owen realized he could build a recreation of his original body.

Owen briefly threatened to destroy the world and even apparently killed some of the Avengers. However, Tigra convinced him to give himself up and seek psychiatric help.

#### **RUNNING THE MOLECULE MAN:**

Owen is a nerd, a crazy little geek who just happens to have incredible powers. He likes to use his powers to live out his fantasies. The problem is that many of his fantasies involve conquering the world. Owen is very obedient to his doctors and to Tigra, on whom he has a crush.

### **PSYCHO-MAN**

F	PR	(4)	Health: 34
A	TY	(6)	
S	PR	(4)	Karma: 80
E	EX	(20)	
R	AM	(50)	Resources: MN(75)
I	EX	(20)	
P	GD	(10)	Popularity: 0

#### **KNOWN POWERS:**

The Psycho-Man's powers are derived from his Battlesuit and Emotion Control Box.

*Battlesuit:* This is a series of exoskeletons that resembles his physical body but on a larger scale.

*Human-size:* This version provides him with Amazing protection from physical and energy attacks and has these abilities:

F A S E  
EX EX MN MN

*Giant version:* This is a robot controlled by Psycho-Man from a control room either in the robot's body or in another location altogether. The giant stands 200 feet tall. It has Amazing Material Strength and Excellent speed. Attacks

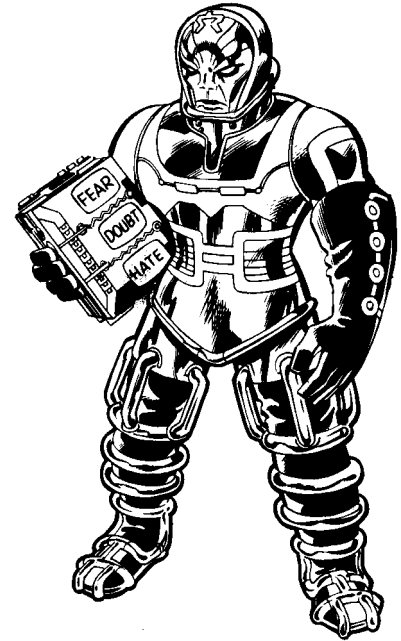

made against the robot do not directly affect Psycho-Man.

F A S E  
AM EX UN UN

*Emotion Control Box:* This box has the Monstrous ability to completely fill a target's mind with the emotional states of fear, hate, or doubt. Range is limited to two areas. Effects last 1-10 turns per exposure. Victims struck by the box's conical beam must make an Intuition FEAT or suffer the following effects:

- Fear—Victims either flee the scene or are paralyzed with fright.
- Doubt—Victims can not initiate any actions at all.
- Hate—Victims are filled with a homicidal frenzy directed against anyone the victim was previously inclined to dislike. Curiously, feelings of love are perverted into the greatest intensities of hate.

**TALENTS:** Psycho-Man is a scientist, studying psychology and psychomechanics.

**CONTACTS:** None.

**BACKGROUND:** Psycho-Man was the chief scientist of Sub-Atomica, a world in the Microverse. When he was ordered to find new worlds to colonize, he chose to concentrate on extradimensional worlds. His initial target was Sub-Atomica's neighbor, Earth. He fashioned his battle



armor and emotional weaponry and traveled to Earth. His plan was to acquire the earthly materials for a large-scale emotional control ray, then use that ray to conquer Earth. He was defeated after battles with the FF, Inhumans, and the Black Panther.

After that he remained in the Microverse, content to attack visitors to his realm. He even conquered Sub-Atomica. Finally he decided the time had come to conquer Earth. He created the android Hate-Monger (III) and returned to Earth. He brought Sue under his power and transformed her into Malice. When Sue regained her mind she swore vengeance against the Psycho-Man. She achieved it when she turned his own Emotion Control Box against him, driving him incurably insane.

**RUNNING THE PSYCHO-MAN:** Psycho-Man revels in the power his devices give him. If he is feeling superior, he confronts his victim directly. Otherwise he secretly works through agents. The fact that his giant self is a robot is a closely held secret.

## RED GHOST

Ivan Kragoff

F	GD	(10)	Health: 90
A	EX	(20)	
S	GD	(10)	Karma: 46
E	AM	(50)	
R	RM	(30)	Resources: RM (30)
I	TY	(6)	
P	GD	(10)	Popularity: -5

### KNOWN POWERS:

*Phasing:* The Red Ghost has the ability to render his body intangible at will and can maintain this state indefinitely. Note that when he first gained the power, he was stuck in his ethereal state. He can induce this change with Unearthly ease. A side effect of the power transforms his current garments into ethereal matter as well as converting normal air into its ethereal equivalent (thus allowing the Red Ghost to breathe).

The Red Ghost remains visible when he uses his power. He can vary the way his power affects his body; his body can appear to be visibly normal (albeit intangible) or mist-like.

While he is in this ethereal state, the Red Ghost cannot be harmed by any physical attack or by energy attacks



whose intensities are less than Unearthly. He can still be attacked by mental or magical means or by another person who also possesses this power.

As a recently discovered power stunt, the Red Ghost can affect others as well as himself with a successful Psyche FEAT against his target's Psyche. If the Red Ghost succeeds in turning a foe ethereal, he will usually let the target drift about helplessly.

**TALENTS:** Kragoff is a scientist skilled in the fields of rocketry, engineering, physics, and animal training.

**CONTACTS:** Through most of his career his only trustworthy aides were his three trained apes (Igor, Miklho, and Peotor). In his initial exploits the Red Ghost was a favored minion of the Soviet Politburo. Later he struck out and turned renegade supervillain. He has formed temporary alliances with the Mole Man, Attuma, and the Unicorn.

**BACKGROUND:** Kragoff was a Soviet scientist who distinguished himself in his work on rocketry and the techniques for radiation-induced super-powers. Kragoff convinced the Soviets to fund a rocketship that he and his trained apes would use in an attempt to gain super-powers. Unbeknownst to his superiors, he timed the launch to coincide with the FF's first

moonflight. His intent was to battle the FF on the moon. While he and his apes were able to gain super powers, they were defeated by the FF. During a rematch in the Blue Area of the moon, the Red Ghost fell into the Watcher's teleporter and was transported to the Politburo. Embarrassed by his defeats, the Politburo expelled him. He eventually escaped from the USSR with his apes and began a career as an independent supercriminal.

**RUNNING THE RED GHOST:** Originally Kragoff balanced his drive for personal power with his urge to serve the USSR. Now he is free to serve himself.

## THE SUPER-APES

Igor

F	GD	(10)	Health: 60
A	EX	(20)	
S	GD	(10)	Karma: 18
E	EX	(20)	
R	TY	(6)	Resources: N/A
I	TY	(6)	
P	TY	(6)	Popularity: 0

### KNOWN POWERS:

*Shapeshifting:* Igor has the Amazing ability to transform himself into any shape he wants. He is limited to shapes roughly equal to his normal size. However, he can only make baboon sounds if he attempts to resemble a human or humanoid.

**TALENTS:** Igor is trained to assist in lab work and in operating spaceships. While it was originally thought the Super-Apes needed the Red Ghost's direct control, they can now function independent of a human controller.

Mikhlo

F	GD	(10)	Health: 110
A	GD	(10)	
S	AM	(50)	Karma: 18
E	IN	(40)	
R	TY	(6)	Resources: N/A
I	TY	(6)	
P	TY	(6)	Popularity: 0

### KNOWN POWERS:

*True Invulnerability:* He has Incredible protection against physical and energy attacks.

**TALENTS:** Mikhlo is trained to assist in laboratory work and rocketship piloting.



### Peotor

F	TY	(6)	Health: 76
A	EX	(20)	
S	GD	(10)	Karma: 18
E	IN	(40)	
R	TY	(6)	Resources: N/A
I	TY	(6)	
P	TY	(6)	Popularity: 5

### KNOWN POWERS:

*Magnetism:* Peotor has Amazing power to attract and repel metallic objects.

**TALENTS:** Peotor is trained to assist in laboratory work and to pilot a rocketship.

## PUPPET MASTER

### Philip Masters

F	FE	(2)	Health: 16
A	TY	(6)	
S	PR	(4)	Karma: 115
E	PR	(4)	
R	EX	(20)	Resources: GD (10)
I	EX	(20)	
P	MN	(75)	Popularity: 0

### KNOWN POWERS:

*Sympathetic Magic:* By means of special methods he developed, the Puppet mas-

ter gains Monstrous rank Mind Control. The process requires him to carve and color an effigy of his intended victim from radioactive clay he brought from Wundagore Mountain in his native Transia. Once the effigy resembles a specific individual, he can grasp it and actively control the real person's body and mind. By physically manipulating the figure, he can cause his victim to perform identical movements. Such cases cause the victims to retain consciousness but lose control of their bodies. The Puppet Master can even control a person by simply grasping the effigy and concentrating on it. This enables him to perform more complex feats. He is able to blot out a victim's mind, alter the victim's memory, and force them to perform complex activities. Generally he can control only a single individual at one time.

Note that Masters does not know his power is Magical in nature. Note also that because the effigy must continually resemble the victim, Masters is incapable of directly harming a victim by mutilating the effigy. The reason is that altering the effigy's appearance automatically breaks the control over the victim. *Mind Transferral:* With Dr. Doom's assistance, Masters developed this power with Monstrous rank. By using his special clay and Doom's devices, he was able to transfer the minds of the main FF team, as well as Franklin, Alicia, Dr. Doom, and Masters himself into miniature android bodies.

*Mineral Body:* Early in his career, Masters' body was destroyed in a battle with the FF. However, his conscious mind survived and was able to create a duplicate body from his own clay. This new body resembled his original body but possessed unique features. Masters was able to split himself into 1-10 smaller replicas. These replicas shared a communal mind but were capable of independent actions. Furthermore, each replica was capable of shapechanging to become an effigy of an intended victim. Once the change was complete, the effigy could control that person's actions with Monstrous Mind Control. Masters' clay form was later returned to normal flesh.

### WEAPONS:

*Radioactive Clay:* As stated above, Puppet Master's powers are derived from his special clay. This radioactive clay contains low level isotopes and emits Feeble

radiation; it is incapable of directly harming anyone. The clay comes from deposits found on Wundagore Mountain in Transia (see the Wundagore entry in the Travel Guide). While Masters originally attributed its powers to its isotopic content, the truth is that the clay possesses magical energy leaked from the body of the demon Cthon, who was trapped for centuries beneath Wundagore.

The clay can only be used to form a single effigy. Once that effigy is no longer used, the magic and radiation dissipate. Because of this, Masters must periodically return to Transia for a fresh supply. **The Liddleville Device:** This is a tabletop diorama and computer system built by Masters and Doom. When a person under Master's control lays on one of the pallets ringing the table, that person's mind is transferred into a miniature android replica (see "Liddleville" in the Travel Guide).

**TALENTS:** Masters is an excellent toy-maker and sculptor specializing in portraiture.

**CONTACTS:** Masters is uncle to Alicia Masters Storm. He is a past ally of Egghead (deceased), Dr. Doom, the Mad Thinker, and the Wizard; however, he is currently an enemy of the three survivors. Since his reformation, he might be able to gain the FF's help in special cases.

**BACKGROUND:** Masters is a Transian emigrant. He rapidly learned English and American customs but found it difficult to make friends. He retreated into his hobby of carving dolls.

In college he studied biology and gained his first friends, Jacob Reiss and his fiancée Marcia Deaton. After graduation, Reiss and Masters formed a small research firm in upstate New York. Masters began to turn bitter as he resented his partner's wealth, wife, and daughter Alicia. He decided to sabotage the lab. The explosion killed Reiss, blinded Alicia, and eventually poisoned Marcia.

Masters eventually married Marcia and adopted Alicia. He continued to research means of curing Alicia's blindness. After Marcia's death, Masters sold the lab and retreated from the world. During this period he taught Alicia to sculpt and learned she had a natural gift for it.

He also discovered that the clay he had brought with from Transia gave him



special powers. Early experiments led to direct confrontations with the FF and the beginning of a long-running battle. The tensions escalated when Alicia and Ben fell in love. Masters was obsessed with his idea of Alicia's welfare and sought to destroy the Thing as a means of protecting her. It was only during the Liddleville incident that he realized she really did love him. Since that time, his protection of Alicia has expanded to include his new son-in-law and the rest of the FF.

**RUNNING PUPPET-MASTER:** Masters is out to stretch the limits of his powers rather than use them to loot or conquer. His main drive is his love of Alicia and guilt over causing her blindness.

## NICHOLAS SCRATCH

Nicholas Harkness

F	GD	(10)	Health: 60
A	GD	(10)	
S	GD	(10)	Karma: 80
E	RM	(30)	
R	EX	(20)	Resources: EX (20)
I	EX	(20)	
P	IN	(40)	Popularity: 30

### KNOWN POWERS:

*Ritual Magic:* By combining specific chants and gestures, Scratch can create magical effects of up to Monstrous power. These effects can simulate the effects of a number of powers; each power is treated as a Power Stunt that he can use easily:

- Force Field
- Force Field v. Hostiles
- Force Field v. Magic
- Reflection
- Resistance to Magic
- Extradimensional Detection
- Life Detection
- Magic Detection
- Power Detection
- Psionic Detection
- Biophysical Control (Healing)
- Biophysical Control (Disruption)
- Hypnotic Control
- Mind Control
- Neural Manipulation
- Shapechange Others
- Summoning
- Magic Control
- Magic Domination
- Mind Control
- Sympathetic Magic
- Communicate with Animals
- Communicate with Plants
- Dreamtravel
- Empathy
- Free Spirit
- Sensory Link
- Telepathy
- Dimension Travel
- Gateway

**TALENTS:** Scratch was fully trained in the arcane arts due to his Mystical origin. He is an expert in Occult Lore and can identify any magical artifact with Amazing ease (a green FEAT).

**CONTACTS:** Scratch was leader of the New Salem Witches. He is the son of Agatha Harkness and father to the Salem's Seven.

**BACKGROUND:** Nicholas Scratch is the son of Agatha Harkness. He inherited her magical powers and became the second most powerful of the New Salem witches. He resented his mother's abandonment of New Salem in favor of the outer world. He decided to return her to New Salem. However, he knew she would resist a forced return; he was also aware of her connections with the FF. Since attempting to bring her home

would mean a major battle, he decided to transform his children into magical, demihuman warriors who could do battle against the powers of the Fantastic Four.

Scratch sent the Salem's Seven to kidnap Agatha; they grabbed Franklin as well. Then he sent an Eliminator to erase all trace of her existence. Both actions brought the FF into direct conflict with Scratch. He and the Seven were able to defeat the FF, but he had not planned on Franklin's incredible powers suddenly appearing. Scratch was banished into the Dark Dimension.

He immediately devised a new plan. He possessed Franklin and set him against his parents. Then while they were en route to New Salem to exorcise Franklin, Scratch freed his children, the Seven. Once they defeated the FF, he planned to use Franklin to reverse the spell of banishment. In the ensuing chaos, the forces of the Dark Dimension would rush out and destroy the outer world.

Scratch was betrayed by his feelings for his mother. When he realized Agatha was prepared to die in order to stop his plan, Scratch surrendered. Agatha removed his powers and returned him to the Dark Dimension.

With the destruction of New Salem, Scratch is trapped in his exile without hope of pardon.

**RUNNING SCRATCH:** Scratch has an unbridled hatred of normal, nonmagical humans. Although he couches it in terms of revenge for the centuries of oppression suffered by witches, the simple truth is he is a bigot. However, he is a clever strategist and will not strike until his plans and preparations are complete.

His devotion to his mother will always lead to his ultimate downfall.

## SALEM'S SEVEN

The New Salem Witches selected seven of their number to receive special powers. They chose the grandchildren of Agatha Harkness, since that bloodline represented the strongest magic of all the New Salemites. The combined powers of the 666 were focused on the chosen seven. The combined magical power caused the seven to spontaneously mutate into superhuman forms. The Seven battled the FF when they arrived to rescue Agatha Harkness and even came close to defeating them. Nicholas Scratch was banished to an-



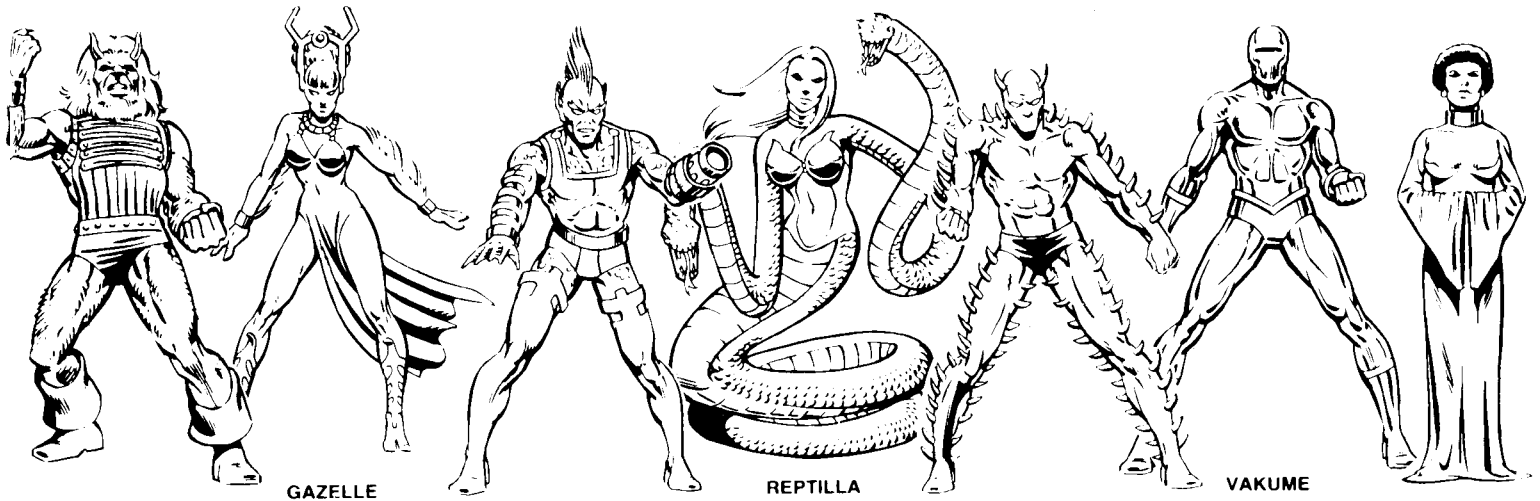

**BRUTACUS**

**GAZELLE**

**HYDRON**

**REPTILLA**

**THORNN**

**VAKUME**

**VERTIGO**

other dimension and the Seven were imprisoned in a magically fortified prison.

Months later Scratch managed to possess Franklin. As the FF rushed to New Salem to exorcise Franklin, Scratch aided the Seven in escape. The Seven defeated the FF in a sudden ambush. When Agatha forced Scratch's surrender in the spiritual encounter during his attempt to release the forces of the Dark Dimension into the outer world, the Seven surrendered as well. Agatha stripped their powers away.

Months later the Seven were able to restore their powers. They took revenge on Agatha by burning her at the stake. They then fought the Scarlet Witch and Vision. During the battle that followed, all the Seven were killed along with the rest of the New Salemites. Their spirits remain active in another plane of existence.

## BRUTACUS

F	AM	(50)	Health: 185
A	GD	(10)	
S	MN	(75)	Karma: 32
E	AM	(50)	
R	TY	(6)	Resources: TY (6)
I	TY	(6)	
P	EX	(20)	Popularity: 0

### KNOWN POWERS:

*Demihuman body:* Brutacus resembles a horned lion-man. Natural Weaponry: His fingers end in claws that do Remarkable damage.

**TALENTS:** Brutacus is trained in sorcery.

**CONTACTS:** Brutacus served Nicholas Scratch as a member of the Salem Seven. Later he aided the demon Sammhain attempt to reach the Earth dimension.

**BACKGROUND:** Brutacus was a normal New Salemite before his transformation.

**RUNNING BRUTACUS:** Brutacus is almost bestial in his fury. He constantly rages against anyone who has ever crossed him.

## GAZELLE

F	EX	(20)	Health: 80
A	RM	(30)	
S	GD	(10)	Karma: 40
E	EX	(20)	
R	GD	(10)	Resources: TY (6)
I	GD	(10)	
P	EX	(20)	Popularity: 3

### KNOWN POWERS:

*Hyper-running:* Gazelle can run at Good speed (60 mph).

*Hyper-Leaping:* Gazelle can make Remarkable leaps of up to 40' across or straight up. She can descend 60' without harm. Her kicks do Remarkable damage.

**TALENTS:** Gazelle is a superb Gymnast. She knows Martial Arts E and Acrobatics.

**CONTACTS:** Gazelle is a member of the Salem Seven in the service of Scratch.

**BACKGROUND:** After Harkness was killed, Gazelle rebelled against the oth-

ers' plan to kill the Scarlet Witch as well. As punishment the others sentenced her to be a human sacrifice. Everyone died before the sacrifice could occur and Gazelle's spirit was free to enter a peaceful afterlife.

**RUNNING GAZELLE:** Gazelle was originally a loyal member before the others' cruel streak turned her against them. Now it is likely her spirit would return to aid victims of the others' supernatural plots.

## HYDRON

F	GD	(10)	Health: 50
A	GD	(10)	
S	GD	(10)	Karma: 36
E	EX	(20)	
R	GD	(10)	Resources: TY (6)
I	TY	(6)	
P	EX	(20)	Popularity: 0

### KNOWN POWERS:

*Demihuman Body/Liquid Life:* Hydron resembles a piscine or fish-man. However, his skin is actually a transparent shell covering his true form, a purely aqueous body.

*Water Generation:* Hydron can generate an limitless supply of water within his body. He can release it through the nozzle covering his left hand. The stream is capable of doing Remarkable physical damage. It can also short out electronics and negate fiery attacks.

**TALENTS:** Hydron is trained in sorcery.

**CONTACTS:** Hydron is a member of the

Salem's Seven in the service of Scratch. He aided Samhain's attempt to invade Earth.

**RUNNING HYDRON:** Hydron prefers to attack without warning or to keep the fight within close quarters where his effectiveness is greater.

## REPTILLA

F	IN	(40)	Health: 100
A	RM	(30)	
S	EX	(20)	Karma: 32
E	GD	(10)	
R	TY	(6)	Resources: TY (6)
I	TY	(6)	
P	EX	(20)	Popularity: -5

### KNOWN POWERS:

*Lamian Body:* Reptilla's legs have been transformed into a sinuous serpentine tail. Her arms have been transformed into snakes as well; each arm-snake has its own head in place of the hand. The arm-snakes can constrict to do Excellent damage each round.

*Poison Bite:* The arm-snakes have Excellent-intensity poison. Victims must make an Endurance FEAT or fall unconscious for 1-10 hours. Failure to make a second FEAT decreases the victim's Endurance -1CS.

**TALENTS:** Reptilla is a sorceress.

**CONTACTS:** Reptilla is a member of the Salem Seven in the service of Scratch. She aided Samhain's attempt to invade Earth.

**RUNNING REPTILLA:** In combat Reptilla attacks the weakest target, often holding the victim hostage to order her other foes' surrender.

## THORNN

F	GD	(10)	Health: 60
A	EX	(20)	
S	GD	(10)	Karma: 32
E	EX	(20)	
R	TY	(6)	Resources: TY (6)
I	TY	(6)	
P	EX	(20)	Popularity: -3

### KNOWN POWERS:

*Missile Creation:* Thornn's body is covered with thorns that he can fire at will. The thorns have Remarkable accuracy, a range of 1 area, and do Remarkable

damage. He possesses 76 thorns; lost thorns regenerate in 10 rounds.

**TALENTS:** Thornn is a sorcerer.

**CONTACTS:** Thornn is a member of the Salem's Seven in the service of Scratch. Thornn led the effort to capture the Scarlet Witch and lead Samhain to Earth.

**RUNNING THORNN:** Thornn prefers to fight at a distance with his thorns rather than engage in hand-to-hand combat.

## VAKUME

F	GD	(10)	Health: 50
A	GD	(10)	
S	GD	(10)	Karma: 50
E	EX	(20)	
R	EX	(20)	Resources: GD (10)
I	GD	(10)	
P	EX	(20)	Popularity: 1

### KNOWN POWERS:

*Phasing:* Vakume has the Excellent ability to become intangible and pass through objects with less than Remarkable material strength. He cannot travel through magical barriers.

*Air Animation:* Vakume has Unearthly control over the atmosphere. His control is limited to removing the air from a target area. Beings within the target area must make an Endurance FEAT. Failure means they begin to suffocate from lack of air; victims fall unconscious for 1-10 minutes.

**TALENTS:** Vakume is a sorcerer and philosopher

**CONTACTS:** Vakume is a member of the Seven in the service of Scratch.

**RUNNING VAKUME:** Vakume is a team player. He believes that acting in unison is the only way to accomplish anything meaningful. He considers ego a waste of time and energy.

## VERTIGO

F	TY	(6)	Health: 48
A	TY	(6)	
S	TY	(6)	Karma: 40
E	RM	(30)	
R	GD	(10)	Resources: TY (6)
I	GD	(10)	
P	EX	(20)	Popularity: 2

### KNOWN POWERS:

*Biophysical Control (Disruption):* She has the Monstrous ability to induce severe nausea in a victim. She can affect everyone she chooses within a 20' cone extending from her face for one area.

Failure on the part of the victim to make an Endurance FEAT means the person loses consciousness for 1 -10 hours.

**TALENTS:** Vertigo is a sorceress.

**CONTACTS:** She is a member of the Seven in the service of Scratch. She aided Samhain's attempt to invade the Earth dimension.

**RUNNING VERTIGO:** Vertigo calmly waits for the optimal moment to strike. She is one of the most level-headed of the Seven.

## TERMINUS

F	UN	(100)	Health: 4200
A	UN	(100)	
S	CL1000		Karma: 250
E	CL3000		
R	MN	(75)	Resources: CL3000
I	MN	(75)	
P	UN	(100)	Popularity: -500

### KNOWN POWERS:

*Cyborg Exoskeleton:* The Terminus armor is an immense robot controlled by the alien Terminus who sits in a control chamber deep within the exoskeleton's head. The above statistics are for the Terminus-exoskeleton combination. The alien Terminus' statistics are:

F	A	S	E	R	I	P
GD	GD	AM	CL1000	MN	MN	UN

The exoskeleton measures 150' tall and weighs several thousand tons. It contains the bulk of Terminus' powers. *Body Armor:* The exoskeleton is composed of Unearthly material. Internal devices increase these defensive properties to give the cyborg Shift-Y protection against physical and energy attacks as well as CL1000 protection against radiation and extreme temperatures.

*Flight:* The Terminus exoskeleton can attain CL3000 velocity (10,000 mph airspeed; lightspeed in space). Terminus cannot travel in hyperspace.

*Telescopic Vision:* Visual sensors give Terminus CL5000 range (500 light years). Unfortunately for Terminus, this power does not allow him to instantaneously

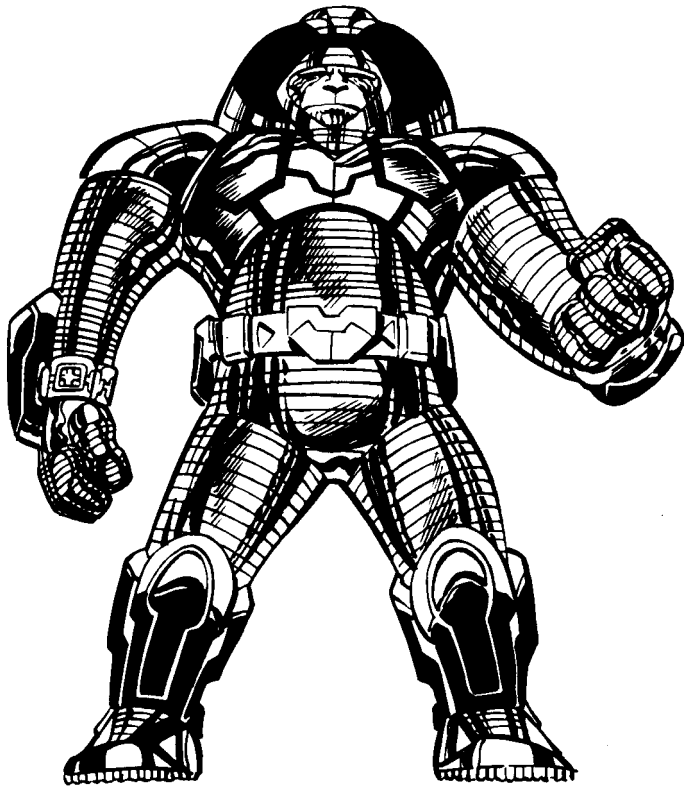

see across great distances.  
**Linguistics:** Inboard translators give Terminus instant translations of any language.  
**Energy Lance:** The Terminus exoskeleton carries a 240' lance made of Uearthly material. This immense weapon contains several powers of its own. Aside from the Flight power, it can only function when held by the Terminus exoskeleton.  
**Plasma Generation:** This CL3000-ranked beam can do concussive damage as well as Shift-Z heat and radiation damage. The power has a normal range of 16 million miles. However, the beam can be coupled with a hyperspace Gateway that permits the beam to reach a target up to two lightdays (32 billion miles) away. Across great distances the beam spreads one area for each 2 billion miles traveled.  
**Disruption:** The lance can surround the Terminus exoskeleton with a ten-mile-radius storm of CL1000-Intensity energy. Molecules within one area of Terminus are immediately reduced to free-floating atoms. The rest of the area is filled with Monstrous Intensity radiation and Uearthly heat.  
**Flight:** The Energy Lance is capable of CL1000 speed. It can independently

travel to any location to which Terminus summons it.

**TALENTS:** Terminus is an expert on mineralogy and interstellar commerce.

**CONTACTS:** None.

**BACKGROUND:** Terminus' origin is unknown. The first anyone on Earth heard of him was when his energy lance carved the sentence "I claim this world—Terminus" across Nebraska, Colorado, Utah, and Nevada. Two days later he landed in Utah and announced his intention to enslave Earth's people, sell off its technology and resources, and finally break the entire planet down into raw mineral commodities. Terminus viewed this as another standard operation, similar to the operations with which he'd destroyed a number of other planets.

However, he'd decided to attack Earth on the advice of an alien scientist he'd enslaved. The alien had known of Earth's native superhuman population and hoped they would be able to destroy Terminus. The alien died when a displeased Terminus flung him away. However, the alien lived long enough to warn She-Hulk and Wyatt about Terminus. Reed was able to

delay Terminus' plans by using a device that halted Terminus' motion relative to the Earth and drove Terminus into the molten core. Terminus was separated from his lance and had to spend several months digging his way to the surface. He came out near the Antarctic regions of Pangea and the Savage Land. Terminus destroyed both. The Avengers arrived too late to save the local inhabitants; however, they were able to destroy the Terminus exoskeleton. They left the alien Terminus to perish in the Antarctic winter. At this point it is unknown what actually happened to either Terminus or his ruined exoskeleton.

**RUNNING TERMINUS:** Imagine the most evil entrepreneur and strip mine operator you can. That's Terminus.

### MAD THINKER aka "Dr. Jose Santini"

F	TY	(6)	Health: 24
A	TY	(6)	
S	TY	(6)	Karma: 62
E	TY	(6)	
R	AM	(50)	Resources: RM (30)
1	TY	(6)	
P	TY	(6)	Popularity: 7

#### KNOWN POWERS:

**Total Memory:** The Mad Thinker has the Monstrous ability to recall anything he has ever read or experienced. He can organize this information in any way except one that creates new insights. This power gives him the equivalent of some of the Mental powers, which he has developed as Power Stunts:

- **Hyper-Invention**—He is a master of building androids and robots.
- **Weapons Tinkering**—He can build any weapon he has read about; these weapons are often incorporated into whatever robot or android he is working on at the time.

**Mind Transferral:** He can send his mind into any of his androids or robots. This is accomplished by means of a special radio transmitter implanted in his skull. Normally he limits this power to replicas of himself. He also keeps this ability a secret. In this way he can continue his super-villainous career even while in prison. This power also enables him to enter hazardous situations without risking his own life. The maximum range is 250 miles.





**TALENTS:** He is a skilled mathematician who can perform complex equations in his head. He is an expert on the construction of robots and androids.

**CONTACTS:** He is an occasional ally of the Puppet Master, although that relationship broke up after Johnny and Alicia's wedding.

**BACKGROUND:** The Thinker's origin is unknown. He is a brilliant mathematician who has discovered the equations for predicting human responses and even some "random" events. His criminal career was accomplished with such success that police seldom suspected a crime had been committed and never suspected him of being involved.

His first defeat came when he decided to conquer the NYC area and set it up as an independent country under his rule. To this end he lured the FF away with lucrative job offers (since Reed was still recovering his fortune, even he was tempted). The Thinker then took over the Baxter Building and pored through Reed's notes, papers, and devices. The knowledge he gained enabled the Thinker to build the first of his androids. When the FF returned, the Thinker ambushed them. Fortunately he hadn't discovered the safety switch that, when activated, disabled all electronic devices within the Baxter Building. The android was affected since it incorporated equipment the Thinker had scavenged from Reed's labs.

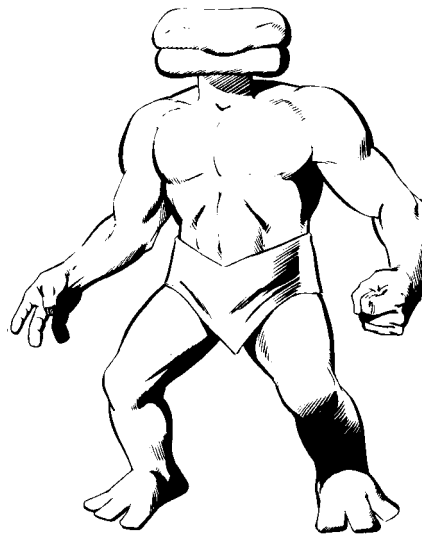

**RUNNING THE MAD THINKER:** He has three goals. The first is the continued accumulation of new knowledge. Second is the accumulation of great wealth. The final goal is revenge on the FF. He prefers to call himself "The Thinker" and gets perturbed that the general public still refers to him as "the MAD Thinker."

## MAD THINKER'S AWESOME ANDROID

F	GD	(10)	Health: 100
A	GD	(10)	
S	AM	(50)	Karma: 6
E	RM	(30)	
R	FE	(2)	Resources: none
I	FE	(2)	
P	FE	(2)	Popularity: 0

### KNOWN POWERS:

**Compound Body:** Awesome is a hybrid utilizing principles of robotic and android design. His basic structure is an artificial flesh derived from the combination of gorilla DNA and unstable molecules. It is controlled by an implanted microcomputer and a solar power cell.

**Armor Skin:** Awesome can temporarily develop hard, rocky plates that resemble the Thing's skin. This gives the android excellent protection from physical and energy attacks.

**Enlargement:** Awesome has the Feeble ability to increase his size by ten percent.

**Hyper-Breath:** it can exhale a blast with a velocity of 180 mph, Excellent Intensity, and Excellent damage.

**Ice Sheath:** Awesome can temporarily cover himself with a flexible sheet of ice that gives him Good protection against physical attacks and Remarkable protection against heat and fire-based attacks.

**Natural Weaponry:** Awesome can transform his fists into granite-like blocks that do Monstrous damage.

**Steel Sheath:** It can also convert its hide to steel of Remarkable Material Strength.

**TALENTS:** None whatsoever.

**CONTACTS:** None.

**BACKGROUND:** Awesome was the Thinker's first android. It was created from notes and materials the Thinker found when he invaded the Baxter Building. The Thinker spliced gorilla DNA to unstable molecules and got a 15-foot-tall, grey skinned brute with a silly head. An implanted microcomputer functions as Awesome's brain; power is supplied by a solar cell.

While the Awesome Android appears quite dangerous, in fact it is rather slow-moving. It is incapable of speech. The Thinker used Awesome several times in his early career as a super-villain, then he abandoned it in favor of later, better designed models. Awesome sat forgotten in a barn in central Ohio until the Super-Adaptoid used the android in his first step of gathering a villainous group of artificial lifeforms.

### RUNNING THE AWESOME ANDROID:

The Awesome Android is a mindless servant who carries out whatever explicit directions are given him by his master.

## HUMAN TORCH I

F	EX	(20)	Health: 100
A	EX	(20)	
S	EX	(20)	Karma: 22
E	IN	(40)	
R	TY	(6)	Resources: none
I	TY	(6)	
P	GD	(10)	Popularity: 20

### KNOWN POWERS:

**Android Body:** The original Torch was an android built by Prof. Horton.



**Energy Sheath (Fire):** The original Torch was surrounded by a fiery field of Amazing Intensity. It gave him Amazing protection against physical attacks since it melted any item with less than Amazing material strength.

**Fire Generation:** The original Torch could emit blasts of Unearthly rank and intensity.

**Fire Control:** He had Unearthly control over flame, whether natural or created from his own powers.

**True Flight:** He could attain Excellent speed.

**Specific Resistance:** He had CL1000 Resistance to Fire and Heat.

**WEAKNESS:** The original Torch was barely in control of his power when he was revived. In the presence of the normal atmospheric concentration of oxygen, he burst uncontrollably into flame. The burning increased rapidly in intensity and began to rob him of his lifeforce. In game terms, his flame increased 10 points in Intensity each turn; he lost an equal amount to his Health. The only way he could control his power was to remain in an oxygen-free environment or to cover himself in a flame-retardant material.

**TALENTS:** None.

**CONTACTS:** The original Torch was a member of the WWII era Invaders and All-Winners Squad super-hero teams. He was a rival of the Sub-Mariner.

**BACKGROUND:** The original Human Torch was an android created by Prof.

Phineas T Horton in 1940. The android believed he killed Horton when he escaped from his holding cell and originally fled from humanity. Soon he came to act as one of the modern world's first super-heroes and aided the war against the Axis. Some time after the war, he was trapped by gangsters and entombed in the southwest. The site was later used by the government to test nuclear bombs; an explosion freed the Torch. He briefly fought crime in the 1950s until his powers began to go awry and he was entombed again.

The Thinker discovered the Torch's capsule and managed to revive the android. Since he controlled the substance that was keeping the Torch's power under control, he was able to order the Torch to seek out and destroy the FF, starting with the new Human Torch, Johnny Storm. In the battle that followed, the android managed to defeat Johnny and was trying to figure a way out of his predicament when Ben and Reed arrived. When the Thinker tried to kill all of them, the android attacked him. The Thinker dissolved the nitrogen cell layer controlling the Torch's power. The Torch blazed out of control and then collapsed, apparently dead. The Thinker escaped but later returned to claim the body. When Ultron approached him seeking spare androids, the Thinker gave him the Torch's body. Ultron then transformed it into the Vision, a later member of the Avengers.

**RUNNING THE HUMAN TORCH:** The original Torch was a valiant crime-fighter who understandably worried about his power getting out of control. He only cooperated with the Thinker out of coercion.

## WENDY'S FRIENDS

F	TY	(6)	Health: 140
A	RM	(30)	
S	PR	(4)	Karma: 146
E	UN	(100)	
R	TY	(6)	Resources: none
I	IN	(40)	
P	UN	(100)	Popularity: -40

### KNOWN POWERS:

**Telepathy:** Incredible rank.

**Empathy:** Incredible rank.

**Emotion Control:** The Friends' most dangerous power is their Unearthly ability to detect and amplify a person's darkest

emotions. Their power can cause Power rank psychosomatic damage if the victim fails his Psyche roll. In severe enough cases, this can cause death.

**True Flight:** Incredible rank.

**Shapechange:** Typical rank.

**Immortality**

**CONTACTS:** Their only surviving human contact is Wendy, a girl in nearby Benson, AZ.

**BACKGROUND:** "Wendy's Friends" are an unknown race of supernatural beings who dwell in caves beneath the Arizona desert. For reasons known only to themselves, they periodically rise from their cave and examine the people living in the area. They force each person to face the dark side of their own spirits. Unfortunately, this tends to kill or drive away most people. (During their last arising, the population of Benson plummeted from 1740 to 28.) Survivors of the encounter tend to become better people (Psyche increases +1CS).

### RUNNING ONE OF WENDY'S

**FRIENDS:** The Friends are an almost elemental force. They cannot be physically fought or communicated with. They can, however, be playful when they find pure, innocent souls such as children



# TRAVEL GUIDE

like Wendy.

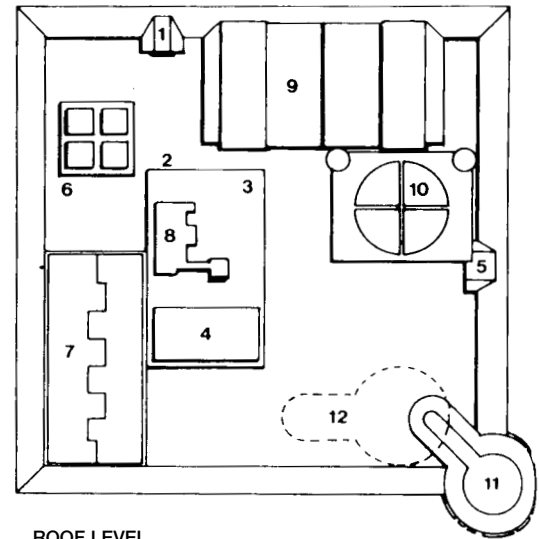
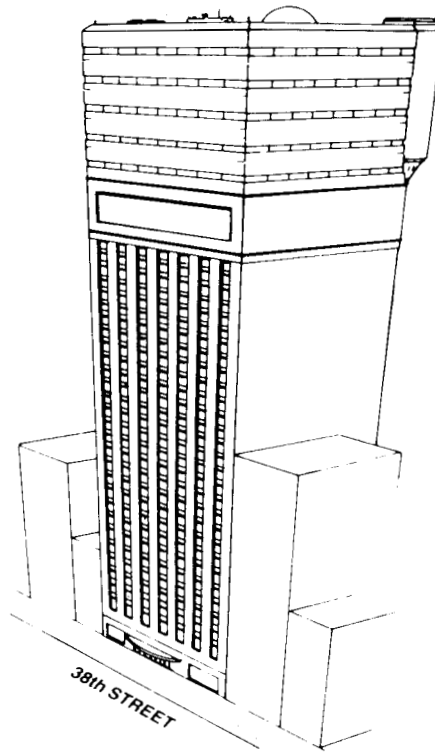

## ROOF LEVEL

1) Reed's elevator exit. 2,3,4) Public access, service, and heavy duty elevators' emergency exits. 5) Emergency elevator exit. 6) Phased array omni-directional radar system. 7) Vehicle maintenance "high ceiling" hatch. 8) Mechanical floor exhaust, detoxification/environmental scrubbers. 9) Hangar roof assembly, rapid opening. 10) Dome of 30" f.1 computer-enhanced prime focus, variable aspheric telescope and twin, companion all-sky cameras. 11) Modified passenger Inter-Continental Ballistic Missile silo hatch. 12) Hatch in stand-by mode.

## THE BAXTER BUILDING

The Baxter Building was the Fantastic Four's original headquarters. It was a 35-story building located at 42nd Street and Madison Avenue in Manhattan. While the popular belief is that the Baxter Building was built and entirely occupied by the FF, in fact they were originally only tenants who rented the top five floors. The building was originally constructed in 1949 by the Leland Baxter Paper Company. Because the building was originally intended to be a high-rise industrial site, each floor was given a ceiling height of 24 feet.

When the FF were first considering moving to NYC, Reed found the Baxter's empty top five floors perfect for their needs. He bought that section of the building outright, though the FF continued to pay monthly service fees. When the FF were in a tight financial situation a year later, Reed resold the FF's floors to Baxter. As tenants, the FF had many problems with Mr. Collins, the building manager. Whereas Mr. Collins had originally been delighted that a real superhero team was moving into his building, he soon began to see the problems in such a situation. When Dr. Doom lifted the entire building into deep space, rela-

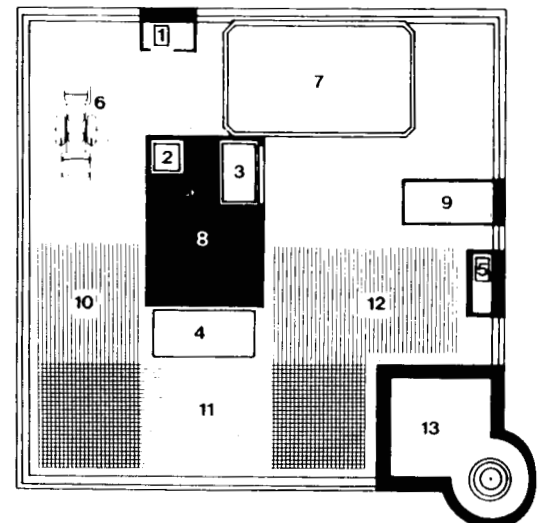

## FIFTH LEVEL

1) Reed's elevator. 2,3,4) Public access, service and heavy duty elevators. 5) Emergency elevator. 6) Hangar. 7) 30 x 40 launch/staging hydraulic lift platform. 8) Mechanical room, heating, ventilating and air-conditioning, water tanks, chemical tanks, fuel storage. 9) Observatory support/access. 10) Vehicle maintenance. 11) Parts storage area. 12) Rocket maintenance area. 13) ICBM component repair level.



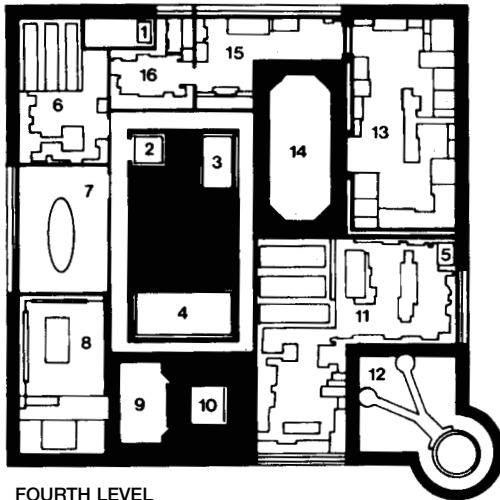

**FOURTH LEVEL**

1) Rood's elevator. 2,3,4) Public access, service and heavy duty elevators. 5) Emergency elevator. 6) Back-up computers, crime files. 7) Conference room. 8) De-briefing, strategic operation room. 9) Negative Zone watch station. 10) Negative Zone portal. 11) Radar/World Watch, Satellite Communications Down-Links, public communications band monitors. 12) ICBM support gantry.

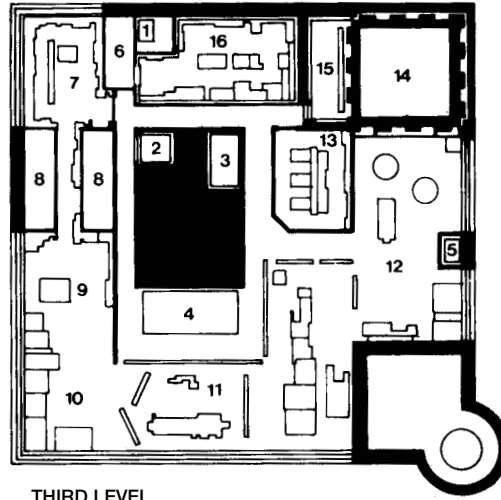

**THIRD LEVEL**

1) Reed's elevator. 2,3,4) Public access, service and heavy duty elevators. 5) Emergency elevator. 6) Detoxification station. 7) Biology Complex. 8) Storage/pathology. 9) Chemistry/Organic Chemistry/Physics Multiplex. 10) Electro-Mechanical workshop. 11) Machine shop, Robotics, large assembly. 12) Physics research & development (variable configuration walls throughout 9 - 12). 13) Computer Center, support for laboratories. 14) Doctor Doom's Time Machine. 15) Time Machine monitor room. 16) Medical Center, recombinant DNA specification quarantine equipped.

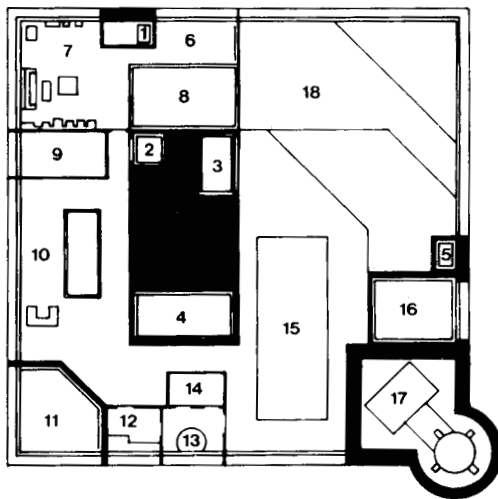

**SECOND LEVEL**

1) Reed's elevator. 2,3,4) Public access, service and heavy duty elevators. 5) Emergency elevator. 6) Visitors' gallery. 7) Recreation room. 8) Regulation Hand-Ball court. 9) Male/female locker rooms, showers, bathrooms. 10) Thing's reinforced weightlifting area. 11) Japanese garden/meditation room, 12) Sauna. 13) Hot tub. 14) Showers. 15) 40-foot swimming pool. 16) Franklin's play room. 17) ICBM base support/exhaust shunt. 18) Multi-level gymnasium.

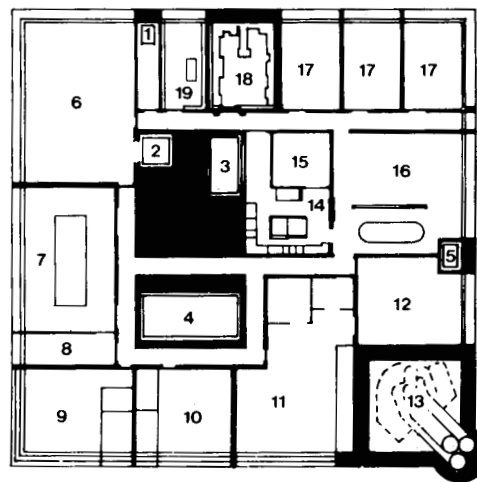

**FIRST LEVEL**

1) Reed's elevator. 2,3,4) Public access, service and heavy duty elevators. 5) Emergency elevator. 6) Public reception area. 7) Formal dining hall. 8) Food preparation area. 9) Ben Grimm's apartment, bath, and storage. 10) John Storm's apartment, bath, and storage. 11) Sue and Reed Richards' apartment, bath, storage, and dressing room, 12) Franklin Richards' room. 13) ICBM exhaust ducting network and blast suppression system. 14) Kitchen. 15) Larder. 16) Informal dining area, lounge and TV area, breakfast corner. 17) Guest bedrooms. 18) Reed's computer-assisted biology r&d laboratory. 19) Reed's office.

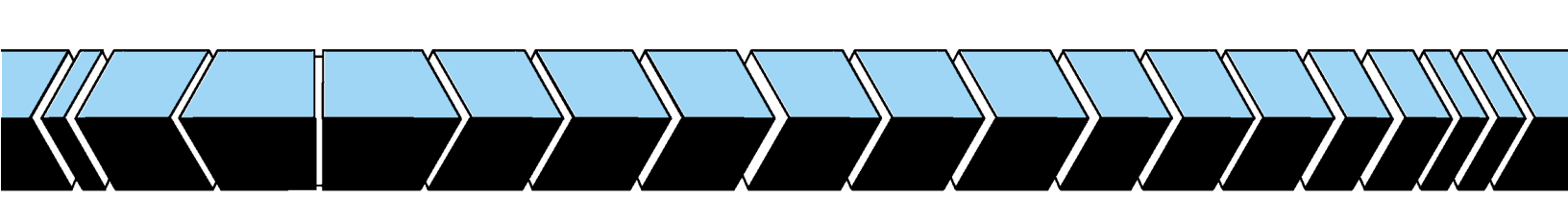

tions cooled between the manager and his tenants. Other tenants worried that their offices might become battlegrounds and, as their leases ended, many of the building's original tenants did not renew. Nor did new tenants appear to fill the vacancies. In desperation Mr. Collins offered all tenants ironclad, 99-year leases with significant discounts in their rents.

Still, problems continued. Occasionally either the Thing or a foe would be driven downward through the building, tearing a shaft through floor after floor. Battles occurred on the outer walls of the building. Explosions were a common occurrence. No insurance company would write a policy on any organization maintaining offices in the Baxter Building.

Collins also discovered that losing the FF as tenants would not solve his problems. During a period when the FF had split up and vacated their headquarters, Collins discovered that no one would rent the FF's former headquarters. There was too great a fear that supervillains would attack those floors regardless of who now lived there.

Then one day Terrax disintegrated everything above the 32nd floor. Collins was fed up. He stormed into the remains of the headquarters and announced he was evicting the FF. Reed suddenly exercised a lease option and bought the entire building outright. That was the last that was seen of Collins. As landlords, the FF tried to be considerate of their tenants. They wished most of the tenants would voluntarily leave, but they realized they were required to honor Collins' special leases. The final act in the Baxter Building's history came when the entire building was once again pulled into orbit, only this time it was blown up.

Fortunately, no one was in the building except for the FF. Still, when the FF returned to the empty foundation, they found angry tenants demanding action. Reed announced that he would establish an insurance pool to cover the tenants' losses and to help them find new offices. Then he set about designing a new headquarters to be erected in the same site.

#### **LOBBY AND ELEVATOR**

The ground floor contained Abe Shoenstein's snack shop, an optometrist's shop, a visitors' center, the elevator bank, and the freight loading dock. The visitors' center was as close as most people could get to the FF; a multimedia

show on the FF's history was shown hourly from 9 to 4. The floor directory listed building tenants such as Pierre Picolino (a famous abstract sculptor), the Ladies' Canasta and Mah Jongg Society, and Fantastic Four Inc. Three elevators serviced floors floors 1 through 30. The fourth elevator was marked by the FF's insignia.

This was the express elevator to floors 31 through 35, the FF's headquarters. The elevator could only be summoned by a solenoid activator such as were imbedded in the FF's belt buckles (intruders could trick the elevator by an Incredible Reason FEAT.) On the way up, hidden scanners identified the passengers and checked them for hidden weapons or devices. If questionable material was found, the elevator would stop in mid-shaft until the FF was prepared to deal with the intruder. The elevator had Remarkable Material Strength.

If a visitor chose to take one of the regular elevators, he was taken to the 30th floor. The bulk of the floor was occupied by the building's mechanical systems (plumbing, ventilation, and elevator winches). This floor also acted as a buffer zone to absorb damage from battles in the upper floors. It also contained the magnetic repeller system. This system was designed to lift the upper floors away from the rest of the Baxter Building; the theory being that this way the rest of the building could have been protected from a particularly damaging battle. The system was designed as a compromise to placate Collins, the building manager. It was controlled from the Computer Center on the 33rd floor.

#### **FF HEADQUARTERS**

All the typical visitor saw on the 30th floor is the FF's reception area. The visitor was greeted by Roberta, a usiform robot. Her visible half (above the waist) appeared to be an attractive blonde in her 20s. Below the waist she was a pivoting arm attached directly to her desk. Roberta was tied directly to the FF's computer system and could monitor the entire building. The reception room was also filled with hidden scanners to probe visitors. If the visitor were hostile, the floor was rigged to deliver a stunning electrical shock of Incredible Intensity. Once the visitor had been cleared, a panel opened to reveal a lift to the 31st floor.

The 31st floor contained the FF's living

quarters. There were suites for the Richards, Ben, and Johnny; several guest rooms for other FF members and the extended family, and the dining and living areas.

The 32nd floor contained more living areas, Alicia's studio (when she was a resident), the medical lab, the library, and reference room.

The 33rd floor contained Reed's laboratory. The floor plan changed constantly as Reed added additional experiments and devices. In the Computer Center was a lever for activating the magnetic repellers on the 30th floor.

The 34th floor could be considered the actual headquarters. The computer banks, monitor banks, communications center, and briefing room were all there, as well as the overflow from Reed's laboratory below. The Astro-sciences section was tied in to SHIELD's and Project Starcore's systems.

The 35th floor contained the hangars for the FF's various vehicles, storage space, and a machine shop capable of building or repairing the FF's vehicles. A reinforced door in the corner led to the launching silo for the FF's rocketship. The vehicles were on platforms that carried them around the floor and over to the launching hatch.

The roof was flat and featureless. A large FF-insignia marked the retractable hatch for launching and landing vehicles. If an FF vehicle approached, the hatch would open automatically. There were a series of observatory domes located at various spots on the roof. Originally a permanent dome was located on the corner opposite the rocket silo. The last dome was closer to the silo but retractable. The entire dome could be lowered through the floor to the 35th-floor hangar. This left the roof completely clear for action and eliminated the only hiding place for a trespasser. The observatory equipment included a computer-linked telescope and twin telescopic cameras.

#### **BUILDING AND SECURITY SYSTEMS**

The walls and floors of the entire Baxter Building had Remarkable Material Strength. After the first time the FF's section was demolished, Reed rebuilt them to have Incredible Material Strength.

Three elevators served Floors 1 through 30. A special elevator served as an express to Floors 31 through 35. Normally this elevator stayed on these

The following is a restored section that appeared in *The Fantastic Four Compendium*. At the time the book was written (1987) Marvel had yet to do a detailed exploration of the FFP. With my background on architecture, I decided to give it a try. After all, Mayfair Games had created the first real maps of Gotham City and Metropolis, maps that were not being used within actual DC comics.

I wasn't so lucky. When the manuscript was sent to Marvel Comics for approval, someone there deleted about half the FFP entry, probably braying that Marvel had the sole right to depict the FFP. As it turned out, no one ever did get around to it. When an entry of FFP finally appeared in a *Handbook of the Marvel Universe*, the text was lifted more or less directly from the obsolete "Baxter Building" entry. The result is surreal. The author gave the correct height for the new building but gave it the same number of floors! 1500' and only 55 floors? That's 27' ceilings!

The following has grown a bit dated over the intervening years. The FF vanished and the interior of floors 71-100 were moved into the Negative Zone. The FF returned and moved to the waterfront.

Alicia turned out to be a Skrull. Crystal, Sharon, Jennifer, and Wyatt moved on. So have we all. But its nice to visit old familiar places. Have fun.



floors and only descended to street level when summoned by a solenoid activator. All elevators doubled as freight elevators.

While the fire stairs extended the length of the building, they were blocked by an FF-insignia marked door on floor 34. The door opened automatically from the inside or could be externally opened by a solenoid activator. Since the door was never used except in emergencies, its opening triggered alarms in the master control and computer systems. This prevented intruders from entering the FF's headquarters by way of the stairwell.

The ventilation and plumbing systems were located on floor 30. The hoists for the three "civilian" elevators were located there also. Acoustic insulation kept the noise from affecting the FF's reception area.

The FF's master computer controlled all locks involving the upper floors. Such locks could be manually operated or overridden by either the master control or the computer system. The locks required an Amazing Reason FEAT to pick, although only an Incredible Intensity FEAT to smash open. The locks were equipped with Excellent intensity electrical shocks to dissuade such efforts.

The computer system maintained visual, audio, biophysical, and electronic surveillance on every section of the building. These operated at Remarkable efficiency. The building was equipped with devices that could disrupt the functioning of a single targeted device or stop the functioning of all electrical machinery within the Baxter Building (this functioned as the power of Machine

Animation at Monstrous rank). This system could be activated by the computer, by Roberta, by someone in the control room on the 38th floor, or by anyone who might punch the "panic buttons" located in every room. If the button were pushed, the field would envelope the entire building.



## FOUR FREEDOMS PLAZA

### THE TOWER

The towering Four Freedoms Plaza is the new headquarters for the Fantastic Four. It is a gleaming concrete and glass skyscraper topped by four immense numeral 4s. It is located on the same site as the old Baxter Building but there is little the two buildings have in common.

When the Baxter Building was hauled into space and destroyed, Reed took the opportunity to increase the space available to the FF. His equipment had already filled every available space and he knew the problem was only getting worse. When the time came to design the FF's new headquarters, Reed decided to triple his building's size. The result is the 1500' tall, 100 story Four Freedoms Plaza.

The building is evenly divided between regular tenants and the FF's headquarters. To make up for the inconvenience the tenants suffered when the Baxter Building exploded,





Reed offered them increased space in the new building but under the old terms, including the 99-year leases. The original Baxter Building occupants occupy floors 1-50 of the FFP.

Floors 51-70 are a buffer zone. Tenants on these floors do not have 99-year leases; they must renew on a yearly basis. This provides the FF with room for future expansion when they finally outgrow their present area.

Floors 71-100 serve as the FF's headquarters. The layout is familiar to the FF in that it matches the old Baxter Building layout. Floor 71 acts as a reception and conference area. The FF's robotic receptionist Roberta guards the entrance to the rest of the building as she sits merged with her desk.

Floor 72 acts as an inn; guest suites fill this usually unoccupied floor. Two water-filled suites are maintained for aquatic visitors such as Atlanteans. One is filled with fresh water, the other with salt water. These suites are actually entered from corresponding swimming pools on the 72nd floor. The pools can also double as aquatic conference rooms. A water-tight elevator connects these suites with the river access tunnel on Sublevel 5.

The FF's living quarters occupy floors 73-75. There are suites for the Richards family; Ben; Johnny and Alicia; Crystal, Luna, and Maya; Sharon Ventura (Ms. Marvel II); Wyatt Wingfoot; an Jennifer Walters (She-Hulk). Other facilities include the kitchen, pantry, spa, two gymnasias (one for normal strength levels, the other for super-strong users), a large library, and a computerized classroom.

Floors 76 and 77 function as the team's command center. Meeting rooms, communications stations, links to Starcore and other astronomical organizations, and a computerized medical station are here.

Floors 78-80 are storage for miscellaneous supplies. These floors serve as future expansion space and as a buffer in case of a disaster in Reed's laboratory. Alicia claimed a section of 78 as a studio for the times she stays in the building.

Floors 81-99 act as Reed's laboratory and storage for his equipment. These floors are possibly the most dangerous place in New York City. Access is strictly controlled by the founding members of the FF. Recently Ben locked these floors to prevent the newer members of the FF from accidentally activating the equipment there. There is an identical workstation on each floor, enabling Reed to work on any floor. The workstation consists of computer terminal, communications console, and mechanical fabricators. None of these workstations is located overhead any other workstation and no three of them are in a straight line. This minimizes the risk of several stations being destroyed in a battle. The workstations are linked to each other and to a similar console in the Richards home.

Floors 90 and 1 contain the Negative Zone Portal. The Portal is in a heavily armored room with walls of Unearthly strength material. A

small adjoining hangar houses the Exploratory Module. Floor 95 contains the Microverse access center. The Reducta-craft and its support services are housed here along with a variety of exotic microscopes capable of perceiving individual atoms and Microversal worlds. In game terms, these viewers have Class 3000 Microscopic Vision.

Floors 98 and 99 serve as warehouse and machine shops. They support the hangar on 100 and act as a buffer to absorb damage from possible hangar disasters. Fuel tanks for the FF's vehicles are on 99.

Floor 100 is the FF's hangar. It fills the space under the four immense 4s that top the building. The hangar is now the exclusive domain of the various model Fantasticars and Skycycles, along with parking for visiting aircraft. Because the FAA and the NYC authorities have finally cracked down on the FF's air traffic, the rocket and Pogo-Plane are no longer housed here. However, facilities for their use were included in the FFP construction plans. If the situation demands, the Pogo-Plane's launch platform is usable immediately. The launch platform extends outward after one of the 4s retracts. The rocket silo can be operational in three days. It is disguised as the central column supporting the roof. Firepits below connect directly to a special Negative Zone portal; this transmits the exhaust directly to the Negative Zone.

#### BASEMENT

The FFP's foundation reaches 150' into the Manhattan bedrock. There are ten floors here. Sublevels 1-2 are used by the building's main-

tenance staff. Sublevels 3-4 contain the freight docks and tenant warehouse facilities. A railroad spur enables large masses of freight to be moved in or out without the need to deal with the impenetrable Manhattan traffic.

Sublevels 5-15 are restricted to the FF. These floors contain special devices and support facilities for floors 71-100. These include a back-up computer system, generators, holding cells, and any large items the FF might not want on the upper floors. Sublevel 5 contains the water-filled conduit that reaches the Hudson River; this permits aquatic visitors to directly reach the FFP without suffering the indignity of having to swim through the NYC sewer system.

#### BUILDING FEATURES

The basic structure of the FFP consists of various combinations of reinforced concrete, steel, and other durable materials. Floors 1-50 are fairly normal construction (Remarkable Material strength). Floors 51-80 are somewhat sturdier (Incredible Material strength). Reed's laboratory floors 81-97 have the highest strength (Amazing). Some internal walls are further reinforced to Unearthly strength; these surround the Negative Zone Portal and Microverse access areas.

Floors 50, 70, and 98 contain the mechanical facilities for the building's ventilation and plumbing systems. The ventilation system contains an auxiliary oxygen supply and air recycling system that can maintain a breathable atmosphere within the building for days.

The FFP is permeated with small tubes 1" in diameter. These run the length of the building.

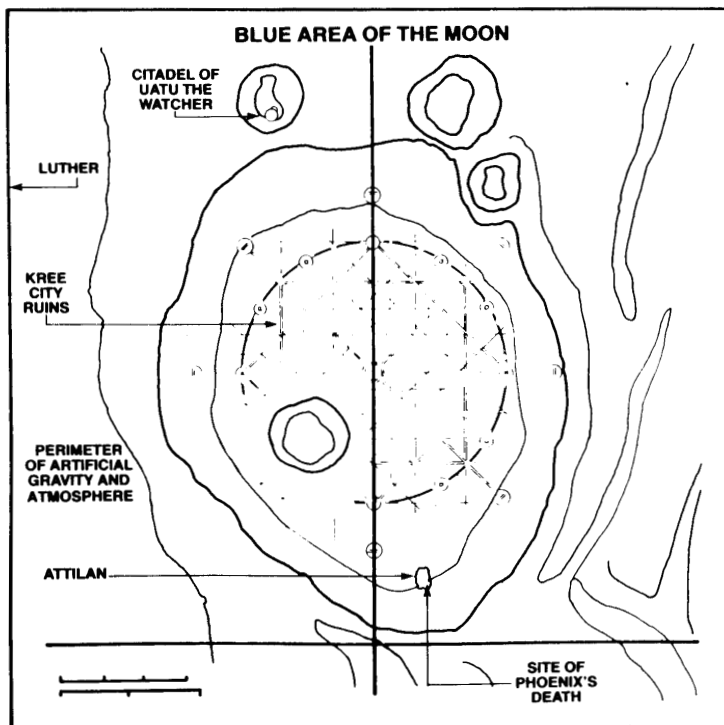





## CENTRAL CITY, CALIFORNIA

This city is the original home of the FF. It was from the the nearby rocket base that Reed and the others blasted off on their fateful trip into space. This was also the place where the FF made their debut as a super-hero team when the Mole Man sent his monsters to attack the surface.

One of Reed's colleagues back then was Harvey Jessup, a nuclear engineer. Jessup became obsessed with the idea of nuclear disaster. He dedicated his life to finding a way to save his family and friends. He found it in the creation of a powerful forcefield that would isolate the community and transport it ahead to a time when the Earth would have recovered from the disaster.

### FIELD GENERATOR

*Reality Alteration (Temporal Flow):* The

device has Beyond-rank ability to speed up the passage of time within its area of effect. The actual rate is 2,000,000:1 (about one month per second). Because of the time difference, radiation cannot pass through the dome in levels high enough to be noticed. This gives the dome a pure black exterior.

As a power stunt, the device can also isolate specific targets from the accelerated time passage; this has the practical effect of putting that person in "suspended animation."

*Time Travel:* The field generator "stores" the time difference. It can use it to make a single time-jump that transports everything within its area of effect to a point in the future equal to the same number of years that has elapsed inside the field.

Jessup was mistaken about the capabilities of his Field Generator. He had reversed the equations and thought that time passed swiftly on the outside of the

dome. As soon as the device was complete, he activated it.

The people of Central City rebelled soon after the isolation occurred. Jessup and his fifty assistants somehow overcame virtually the entire city and placed them all in stasis. Over the ten millennia that followed, Jessup's people proliferated. Because of the small genetic pool, disastrous inbreeding occurred. The people evolved into five breeds: Normals, Head-Brothers, Burners, Flyers, and Clobbers (see below).

Jessup's admiration for the FF led him to create a religion that worshipped them. The myth grew that someday they would arrive to end the long isolation.

### Burners:

F	PR	(4)	Health: 24
A	GD	(10)	
S	PR	(4)	Karma: 22
E	TY	(6)	

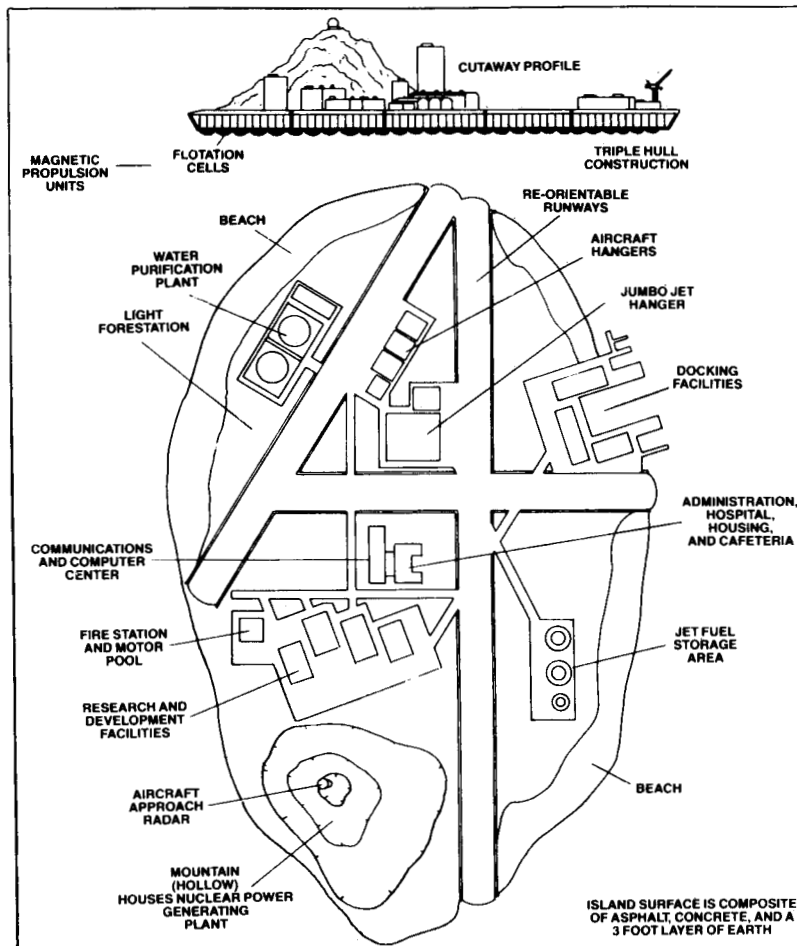

R TY (6)  
 I TY (6)  
 P GD (10)

**KNOWN POWERS:**

*Absorption Power:* The Burners have the Incredible ability to safely absorb fiery attacks.

*Energy Body (Flame):* The Burners have the ability to transform their bodies into animate fireballs of Remarkable Intensity.

*Fire Generation:* Remarkable rank.

*True Flight:* Excellent speed  
 The Burners are bald midgets.

**Clobbers:**

F RM (30) Health: 116  
 A TY (6)  
 S IN (40) Karma: 6  
 E IN (40)  
 R FE (2)  
 I FE (2)  
 P FE (2)

**KNOWN POWERS:**

None.  
 The Clobbers are huge and brutish.

**Head-Brothers**

F FE (2) Health: 16  
 A PR (4)  
 S PR (4) Karma: 52  
 E TY (6)  
 R TY (6)  
 I TY (6)  
 P IN (40)

**KNOWN POWERS:**

*Force Field Generation:* (Excellent rank)  
 Headbrothers have a twin skull and brain. It appears as if two heads were glued together around the ears. The Head-Brothers have two distinct minds, although their muscles operate jointly.

**Winged Flyers**

F GD (10) Health: 46  
 A EX (20)  
 S TY (6) Karma: 18  
 E GD (10)  
 R TY (6)  
 I TY (6)  
 P TY (6)

**KNOWN POWERS:**

*Winged Flight:* Typical airspeed.

Shortly after the dome was created, the West Coast Avengers were called to investigate. Iron Man penetrated the dome (in AD 11885, Dome time) and escaped three weeks later. A few minutes later, She-Hulk accidentally entered the dome (111940, Dome time). She was captured and placed in stasis. In 11990, the FF appeared and fulfilled the prophecy.

Reed made Jessup realize his mistake. Jessup gave Reed the information he needed to correct the situation. Reed arranged to make the bulk of Central City flash forward to the Earth of AD 11990. The subterranean vault with the stasis chambers remained behind. The govern-



ment later declared Central City a disaster area and began helping the people rebuild.

**COUNTER-EARTH**

This was a replica of the Earth created by the High Evolutionary. While it was the same size as the Earth, it was only about as massive as Luna. Its interior was extremely porous and could be considered hollow. (When the High Evolutionary set about building this world, he was limited to the material he could gather from the Asteroid Belt.) Counter Earth shared the same orbit as Earth but was located on the opposite side of the sun. It was not in existence long enough to seriously affect the orbits of the rest of the planets in the Solar System.

The High Evolutionary filled his world with duplicates of people then living on the real Earth. Such people as Reed Richards, Dr. Doom, and Rick Jones all had lives that varied somewhat from their counterparts; for example, Doom was a self-sacrificing hero and Reed was the super-strong Brute.

Counter-Earth was the site of the High Evolutionary's defeat of Galactus. It was home to Adam Warlock for a while. Recently the entire planet was stolen on behalf of a race called the Beyonders and placed on exhibit in a museum. It is considered an example of "local talent."

**HYDRO-BASE**

Hydro-Base is an artificial island floating off the U.S. coast. It is located in international waters about 100 miles east-southeast of NYC. From the surface the Hydro-Base appears to be a natural island complete with a small mountain and industrial plant. However, from below it is clearly an immense barge.

Hydro-Base was constructed by the



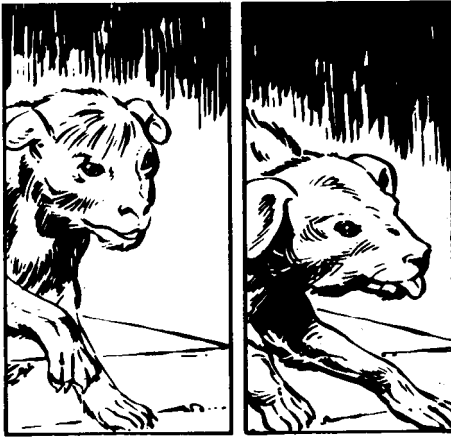

supervillain Dr. Hydro (Dr. Herman Frayne) and used as a base for his operations. After his defeat by Sub-Mariner and Stingray, the island became the temporary home for his victims, the Hydro-men. After Reed and Inhuman scientists finally cured them, the former Hydro-men returned to their real homes. Stingray ended up in possession of Hydro-Base, which now serves as his headquarters and home for he and his wife Diane, as well as for the Avengers after the Masters of Evil destroyed the heroes' mansion.

When the FAA cracked down on the use of the Avengers' and FF headquarters as airports, both groups needed a secure place to base their aircraft. They immediately accepted Stingray's offer of Hydro-base's facilities. The Fantastic Four's Pogo Plane, Intercontinental Passenger Missile (ICPM), and Skrull starship are stored here alongside the Avenger's fleet of Quinjets.

## LATVERIA

The kingdom of Latveria lies nestled in the Balkan region of Europe. It is a small, reclusive country with history rich in magic and tyranny. The region is home to a tribe of gypsy sorcerers, from whom Victor Von Doom is descended. The kings of Latveria always ruled with an iron fist; the punishment for almost any crime was death.

Dr. Doom seized the throne a decade ago when he overthrew King Rudolpho. He ruled the country with the same iron grip that the people were accustomed to. However, Doom's rule was less capricious than Rudolpho's line. Peasants did not suffer whenever Doom was annoyed. The graft and corruption vanished. When Rudolpho's brother Zorba regained the throne, the people originally welcomed him as a savior. However, Zorba soon reverted to his ancestors' corrupt ways. When Doom overthrew Zorba, no one mourned his passing.

Doom has vowed to protect his native land from the outside world. Visas for visitors are virtually impossible to attain. Passports for visits to the outside are equally rare. Apparently the Latverian Embassy in NYC is the only one in the world.

The culture of the country is a curious

blend of pre-Industrial Europe and high technology. It is a common sight to see robot troops walking alongside an ox-cart. All technology is centered in Doomstadt, the national capital. Its original name of Haasenstadt was changed when Dr. Doom took power. The town surrounds the hill where Castle Doom sits. Castle Doom is a sprawling fortress. It was originally built in the 16th century by Count Sabbat, but Doom has almost completely rebuilt the castle. The castle is now a high-technology haven. It contains its own nuclear reactor, airport, factory, and armory. The castle has a staff of 50 humans and 250 robots of various types.

## LIDDLEVILLE

This is a miniature copy of a small town from middle America. Scaled to fit the size of a human one half inch tall (the size of the Wasp at her tiniest), Liddleville was a joint project of Dr. Doom and Puppet Master. The latter wanted to provide a place where Alicia could be happily married to a human Ben Grimm, while Doom simply wanted to trap the FF Puppet Master provided the miniature people and scale model bodies for himself, Doom, Alicia, Franklin, and the FF. Doom then transferred everyone's minds

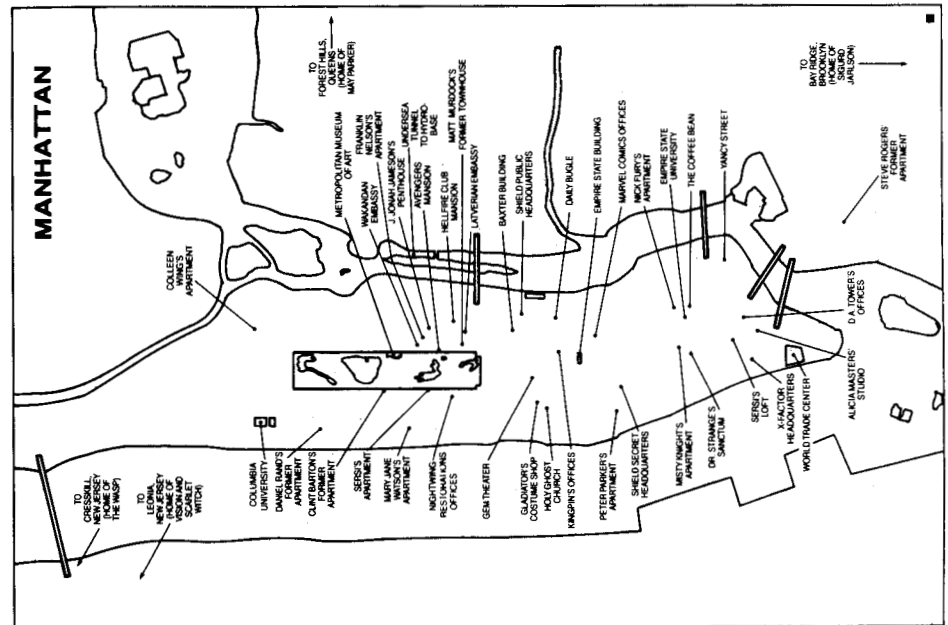



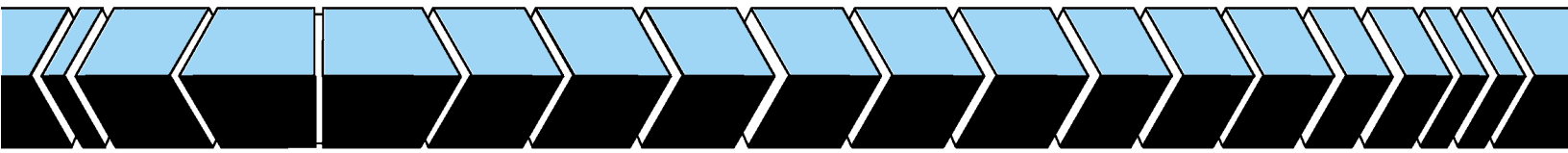

into the miniatures. Fortunately, the FF eventually regained their memories and their rightful bodies. For a time, Puppet Master kept Doom a prisoner in Liddleville, but both eventually escaped each other's assassination attempts. Liddleville is currently sitting abandoned in Doom's castle in the Adirondacks.

The Liddleville model sits on a circular table six feet in diameter. It is surrounded by a ring of computers and pallets for the bodies of people "visiting" Liddleville. The computers can Mind Transfer a person into a synthe-clone puppet. The real body then enters into Suspended Animation for the length of the visit. An overhead magnifier enables a person to view the miniature scene below.

Holographic projectors supply illusions of surrounding countryside and sky. A river runs through town, then is piped back in the other end. The surrounding countryside is patrolled by scale copies of Doom's Guardian-series robots to prevent unwilling visitors from escaping. Even if someone should escape, he would find himself in a world where everything had Incredible Growth.

Doom's fine attention to detail prompted him to make everything in Liddleville functional. The Physics Department of Liddleville College includes a well-stocked laboratory with a particle-accelerator capable of duplicating any hard radiation. When the FF used this on their synthe-clone bodies, they gained more powerful versions of their normal powers. (In game terms, multiply the Power rank numbers by 20; this should yield the miniature equivalents of Shift-Y powers.)

When Doom was trapped in his synthe-clone identity of Vincent Vaughn by the Puppet Master, he built a miniature copy of his Adirondack castle. The castle still stands, despite a disastrous fire that melted Vincent Vaughn's face.

### KING'S CROSSING, NY

The area was the site where the FF first fought the Skrulls. The four Skrull scouts they defeated were hypnotically locked in the shape of cows. There the "cows" stayed for years as part of a local dairy herd. The Skrulls were freed and reportedly killed during the Kree-Skrull War.

During their years spent as cows, the Skrulls produced a milk-like fluid that was indistinguishable from real milk. The Skrull "milk" contained Skrull genetic

material that invaded whoever drank it and transformed them into Pseudo-Skrulls. These beings retained their human appearance but gained Shape-shifting powers and the inherent Skrull urge to conquer. Fortunately for Earth, this drive was transformed into reclusiveness and the urge to create greater crops. Sharon Selleck discovered the Pseudo-Skrull invasion when her car broke down near the town. Her allergy to milk kept her human and enabled her to detect the contamination.

When the FF came to Sharon's rescue, they also cured the people of the Skrull virus. Note: it is unknown how much milk was shipped away from King's Crossing and was therefore not affected by the FF's cure. Anyone drinking the milk will suffer the same effects as the King's Crossing populace. It is also unknown whether the recent energy pulse that stripped all Skrulls of their Shapeshifting power also affected any such Pseudo-Skrulls.

### Pseudo-Skrulls

F	GD	(10)	Health: 28
A	TY	(6)	
S	TY	(6)	Karma: 18
E	TY	(6)	
R	TY	(6)	
I	TY	(6)	
P	TY	(6)	

### KNOWN POWERS:

*Shapeshifting*: Typical rank

**RUNNING A PSEUDO-SKRULL:** The Pseudo-Skrulls are xenophobic but not hostile. They will try to capture anyone who suspects their secret and then force them to drink the Skrull "milk."

### MANHATTAN

Manhattan Island is both the center of NYC and the current home of the FF. It is home to 1.5 million normal humans and a few hundred mutants, altered humans, and aliens of the types who are often called either super heroes or super villains. Because of the high percentage of superhumans living here, Manhattan has had an unusual recent history.

The FF were the first superhumans to publicly live in Manhattan. Their arrival and subsequent love affair with NYC prompted others to move into the area or to reveal their presence if they were already there. This mass immigration had its problems. While the public loved the spectacle of the new super heroes, it also had to contend with the terror brought by the new supercriminals. Occasionally these plots involved the entire island. Manhattan has twice been picked up; the first time it was only suspended one mile in the air, but the second time Terrax lifted the entire island straight into orbit! Manhattan has also been transported into the Atlantic; once when this happened Hercules towed the island backwards into place (the Battery was to the north, Harlem to the south, etc.). The greatest disaster to befall Manhattan occurred during the rampage of Hate Monger III. He incited mass riots that involved virtually the entire population. Arson threatened to burn the entire island to the waterline.

As a side effect of the high superhuman population, Manhattan has been the site of several first contacts with alien races. Several time travelers have made modern Manhattan their destination as well.

Today the public views the superhumans as another ethnic group, albeit an extremely noticeable one. Public opinions vary with each superhuman and with current events. The only group to have a relatively stable public image is the FF. For reasons pollsters have never discovered, the general public has al-

ways felt "good" toward the FF. People always treat the FF with politeness and restraint.

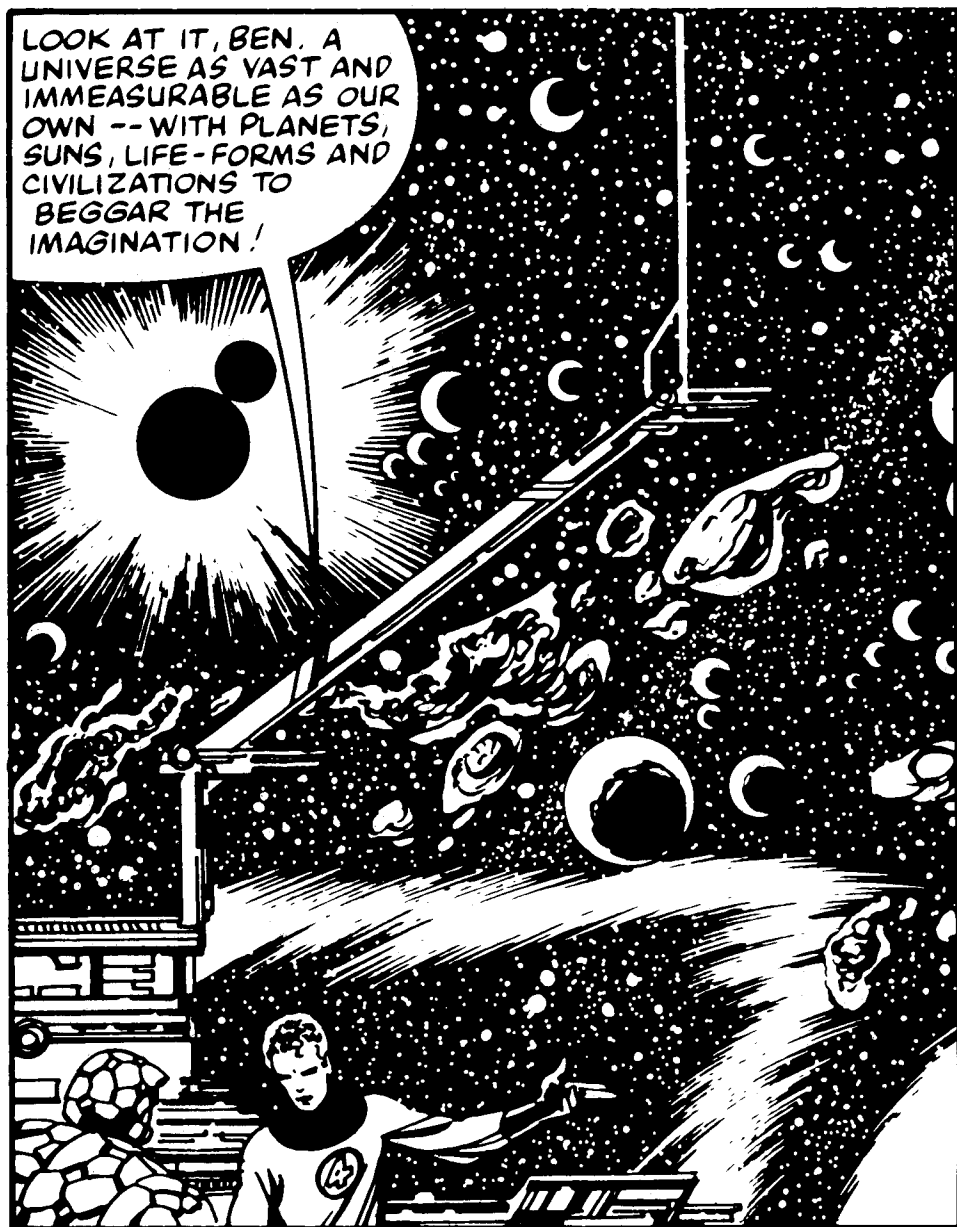

## MICROVERSE

The Microverse is a dimension within our own. The popular conception is that the worlds of the Microverse are our atoms. This misconception is supported by the odd fact that the the Microverse can be reached by the power of Shrinking. In truth the Microverse is simply another dimension just a little smaller than our own. Once a traveler has shrunk down enough to enter the Microverse, he finds himself in a universe similar to our own. Due to an as-yet-unexplained law, most travelers end up

the same size as the humanoids of the Microverse. The exception is made for travelers who "come down" by different means. The microversal gateway in the H.E.L.L. labs in Florida do not miniaturize travelers to the same size as the Micro-worlders. A H.E.L.L.-bound traveler is a mile tall in the Microverse. Conditions within the Microverse do not completely duplicate our own. For example, there are a number of atmospheric pockets scattered throughout what would otherwise be deep space. These pockets form around small asteroids and possess





## NEGATIVE ZONE

The Negative Zone is a parallel universe composed of anti-matter. In size it is equal to that of the Marvel Universe. Time flows at a different rate there, with several months passing in the Earthly equivalent of hours. This helpful fact enables an explorer to take a long journey and still be home for dinner.

The Negative Zone can be entered by anyone with the proper equipment. On Earth, the only portals are located in the FF's headquarters. The original portal was a door seven feet in diameter surrounded by support machinery. Reed built a second portal in the form of a 500-meter shaft, 499 meters of which only existed in the Negative Zone. The portals had safeguards designed to simply break the link between dimensions if the portal were damaged or destroyed. Unfortunately the explosion of the Baxter Building disabled the safeguards. The resulting dimension warp had to be sealed in orbit by a CL1000 matter-anti-matter explosion (Reed's space suit touching Annihilus's armor). Reed has recreated the shaft portal in the Four Freedoms Plaza.

Each portal contains equipment that transforms matter into antimatter (if going into the Negative Zone) or antimatter into matter (if leaving it). This prevents explosions that could possibly destroy all the Northern Hemisphere. This destructive potential is an ultra-classified secret.

Next to each portal is a Negative Zone Viewer. It provides a telescopic view of the other side (Telescopic Vision, Good rank).

When a person travels through the portal, he first encounters the Distortion Zone. This is a section of Subspace that serves as the gateway to all dimensions. It is a turbulent area filled with hypnotic flashes of intense colors.

Once within the Negative Zone, the traveler finds himself in orbit over the Negative Zone's counterpart to Earth. This lifeless world is surrounded by exploding debris. Most of the FF's encounters with the Negative Zone have been limited to this area. However, with the development of the Negative Zone Exploratory Module, the team was finally able to explore an area equivalent to dozens of light-years of space.



### WORLDS OF THE NEGATIVE ZONE

**ARTHROS:** Annihilus' homeworld. This planet is home to mindless insects. All life resulted from the efforts of the Tyannese.

**BALUUR:** Blastaar's homeworld. This is a high-technology world with a star-faring race. Blastaar was originally considered a tyrant there but the people later returned his throne to him. He then forged the Baluurians into an interstellar empire. Much of the Baluurian starfleet was destroyed in the final battle between Blastaar and Annihilus.

**KESTOR'S HOPE:** This two-mile-long starship contains the last survivors of the planet Kestor. The planet Kestor was destroyed ten thousand years ago when its sun went super-nova. The Kestorians only had time to load 20,000 people aboard a great space ark. There they were placed in suspended animation until the ship reached its destination. Unfortunately, the blast devastated the ship. The main computer was demolished and only 500 people survived. They thought they were selected to protect the remaining sleepers. The truth became a secret handed down from First Officer to First Officer for five hundred generations. When the FF intercepted the ship, Reed decided that he could assist the Kestorians finally locate a world similar to lost Kestor. He repaired their ships' computer and brought the ship to a landing. There the Kestorians discovered that they had subtly mutated to the point where they could no longer abide such a world. In the confusion that

followed the emergency lift-off, the captain finally learned the long-kept secret. He died from the shock. When the FF left the Kestor's Hope, the ship sailed on in search of a homeworld.

### Kestorian

F A S E R I P  
GD TY EX EX EX GD TY

**WEAKNESS:** The Kestorians are agoraphobic and require polluted air.

**MANTRACORA:** This world has a culture and technology level similar to medieval Arabia. Thirty years ago an alien crashed there and hid his ship beneath a great temple. He killed the high priest, Taranith Gelstal, and assumed his identity. Then he perverted the religion to fit his needs. His ship's computer was damaged; he decided that humanoid minds could be added to it to replace the damaged circuits. He had nearly completed his repairs when he discovered Reed's presence. He kidnapped Reed and added him to his ship's computer. The rest of the FF rescued Reed and they used the ship to return to Earth in time to defeat Annihilus' latest scheme.

**OOTAH'S WORLD:** Ages ago, the highly advanced people developed a single city controlled by a master computer, Ootah. The city-computer developed self-awareness and saw its inhabitants as parasites. It drove them out by instilling monstrous panic. The people reverted to savagery. They built squalid cities along Ootah's walls. They developed a religion based on appeasing the demon god, Ootah. "Brides of Ootah" were periodically offered to the great portal, where

they were transformed into light. In truth, Ootah's defense systems disintegrated them. When the FF arrived, they helped the people destroy Ootah. Reed now thinks this was a tragic mistake.

**TYANNA:** This high technology world is responsible for much of the life in the Negative Zone. Ages ago their explorer ships were sent out to seed their universe with life.

## PROJECT PEGASUS

The name is an acronym for Potential Energy Group/ Alternate Sources/ United States. It is an advanced research facility sequestered in Athena Mountain in upstate New York. It is chartered and funded by the Department of Energy to explore new energy sources based on renewable resources. However, exploration of the field led to the Project's frequent involvement with the unique power sources present in superhumans.

From outside, the Project appears to be a modest, mountaintop compound consisting of two three-story administration buildings, adjoining optical and radio observatories, a circle of geodesic domes, and a small airport. The bulk of the Project's facilities lie underground in the 24-story "Silo" and connecting modules. The Silo is divided into eight levels (A-H), each of which is further divided

into three floors.

- A Solar Power research
- B Communications
- C Security Systems
- D Administration
- E Central Computer and Housekeeping
- F Building Maintenance
- G Life Support Systems
- H Breeder Reactor

Branching off the Silo are twelve subterranean domes. Six serve as housing for the Project's 1000-odd staff. The remaining domes serve as specialized research facilities. Individual domes are dedicated to the following fields: cosmic energy, thermal energy, nuclear waste treatment, cold fission, magnetism and gravity, and human resources. Transportation is handled by high speed elevators nicknamed "zoom tubes" and a spiral tunnel known as the Loop.

It is the human resources center, nicknamed "the Compound," that gained the Project its notoriety. Under the guidance of Dr. Henri Sorel, the Compound undertook the study of superhumans as power sources. Sorel intended to quantify and catalogue the powers of every superhuman in the country. While budgetary restraints kept him from fulfilling his project, he managed to complete exten-

sive studies on the following people and beings:

Atom-Smasher, Blackout, Bres, Capt. America, the Cosmic Cube, Dazzler, Electro, Equinox, Fusion, Giant-Man II, Klaw, Letha, Moonstone, Nitro, Nuklo, Poundcakes, Quasar, Rhino, Screaming Mimi, Silas King, Solarr, Thing, Thundra, Titania, Vibro, and Wundarr (a.k.a. Aquarian).

This research enabled the government to construct the super-villain prison known as the Vault. The research may also have been made available to Project: Wideawake and other anti-mutant organizations within the government. The research was not always done with the subject's consent, especially if the subject was a super-villain. This denial of subjects' rights, as well as several battles involving superhumans, eventually prompted the government to close down the Compound and transfer the research to other facilities.

Past and present Pegasus staff members include:

- Dr. Myron Wilburn, architectural consultant and now administration director;
- Dr. Anson Harkov, research director;
- Dr. Margaret Mayfair, director of developments, patents, and marketing;
- Dr. Henri Sorel, Compound director;
- Quasar (Wendell Vaughn), security director;
- Guardsman (Michael O'Brien), Quasar's replacement;
- Dr. William Foster (Giant-Man 11), biochemist; and
- Dr. Thomas Lightner, cosmic energy researcher secretly in the pay of Roxxon Oil's Nth Command

## SAVAGE LAND AND PANGEA

The Savage Land and Pangea were a pair of deep valleys hidden in the Palmerland peninsula of Antarctica. They were tucked deep within the volcanoes of the Eternity Mountain range. The Savage Land was created 20,000 years ago as a biological laboratory and testing ground. It is unknown who was behind the experiment (extra-terrestrials, Eternals, and Deviants seem the most likely ones). The results of their experiments survived to the present day. These included recreations of formerly-extinct species like the dinosaurs as well as new species like the animal-men.

The experimental area had been abandoned when it was rediscovered by pre-

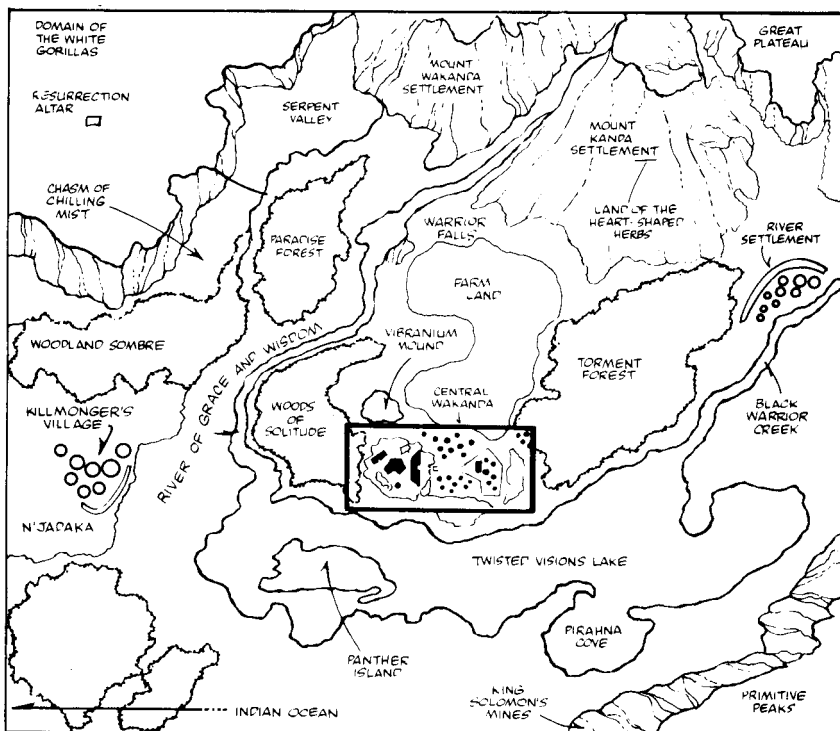

cataclysmic Atlanteans and settled as a colony. The Atlanteans repaired the environmental machinery left by the builders, then used it to increase the habitable land to include the valley they called Pangea. The Atlanteans used Pangea as a resort and amusement center. The Atlanteans discovered how to use the builders' devices to mutate the local natives into a variety of demihumans, such as fish-people, bird-people, and so on. These demihumans were used as laborers. Later the Atlanteans made the machinery self-maintaining and the demihumans were set free to settle the unused sections of Pangea.

With the destruction of Atlantis, the survivors were left on their own. While their civilization survived, it slowly regressed to a barbarous level. A later plate shift dropped Pangea below sea level and cut it off from the Savage Land.

In the 20th century the Savage Land was rediscovered by Lord Robert Plunder, a British scientist and explorer. He discovered a vein of "Anti-metal," a Vibranium isotope that destroys molecular bonds and reduces substances to their component elements. He shared knowledge of the Savage Land with his two sons, Kevin and Parnival. When criminals sought the location of the Anti-metal lode, Robert and Kevin fled to the Savage Land. Robert was soon killed but his son survived to grow into the jungle hero called Ka-Zar.

In more recent years the Savage Land and Pangea were increasingly involved with the modern world. Magneto rediscovered the builders' mutating device and used it to create a team of artificial mutants. Finally, the worldwrecker Terminus discovered the hidden valleys and destroyed them as a test of his destructive abilities. Only Ka-Zar and his wife Sheena survived the catastrophe. Terminus was later destroyed and his armor still remains there. While the builders' environmental machinery was disabled, it may be repairable.

## SUBTERRANEA

The interior of the Marvel Earth is honeycombed with an interlocking series of immense caverns. This cavern system extends as deep as seven miles into the mantle. Subterranea was settled by the Deviants and their human slaves. The Deviants' war with the Eternals had forced them to abandon the surface. The

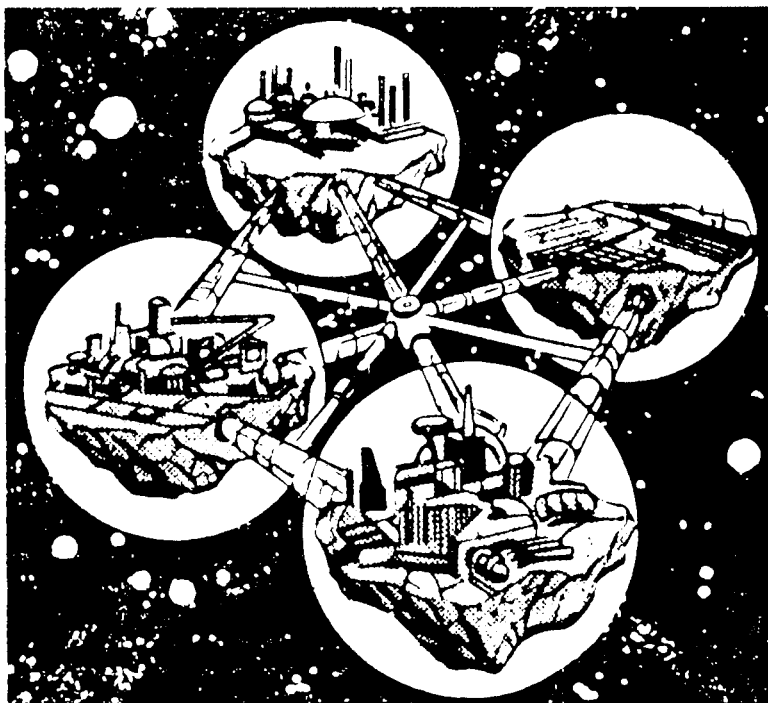

Deviants' science constructed large warrens for their people, built mining and offensive devices of great power, and created several breeds of monsters.

The term "Subterranean" refers to the races that descended from the Deviants' slaves. There are three main types—the Gortokian "Lava Men," the Moloids, and the Tyrannoids. The Gortokians were the first created. They were nearly identical to humans but they possessed adaptations to the dark. After the Gortokians expelled their Deviant masters, they fell to worshipping a demon. The demon later transformed his followers into the Lava Men.

The Deviants then tried again and created two similar races of yellow-skinned humanoid. These later became known as the Moloids and Tyrannoids. These beings were submissive workers and were no match for the Gortokians. The Gortokians eventually forced the Deviants to flee most of Subterranea, and retreat to a single city, the "City of Toads" under the Pacific Ocean.

Although abandoned by their masters, the Subterraneans continued to carry out their duties. Eventually they found new masters. The wizard Merlin banished an evil Roman, Tyrannus, to the Earth's depths. There he discovered his new subjects, the Tyrannoids. Early in this century, the Mole Man discovered his future subjects, the Moloids. He also discovered the great monsters that roam Subterranea.

Other races colonized Subterranea. An

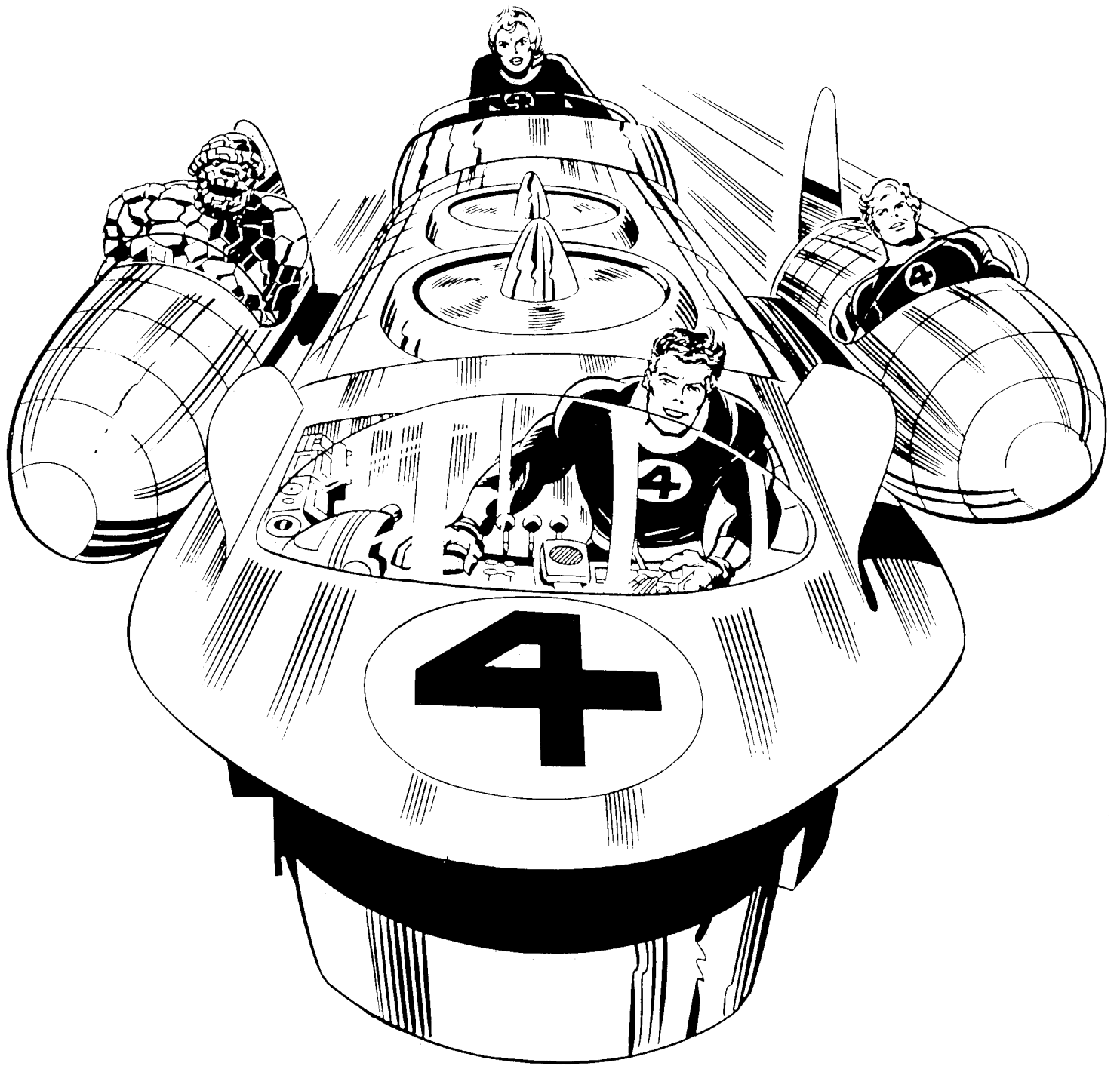
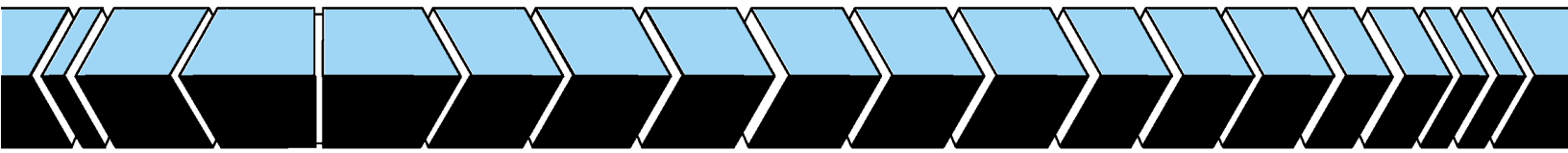



Atlantean city was moved intact to this realm. Netheria now sits in a cavern under the North Atlantic. An Incan city, El Dorado, was hidden beneath the Andes Mountains. The city was recently abandoned after it was wrecked in a battle between the Hulk and Tyrannus.

At the current time, Tyrannus has vanished; Mole Man now commands his Tyrannoids. The Gortokian race was believed destroyed after they encountered surface diseases.

## LAVA MEN

F	GD	(10)	Health: 56
A	TY	(6)	
S	EX	(20)	Karma: 18
E	EX	(20)	
R	TY	(6)	
I	TY	(6)	
P	TY	(6)	

### KNOWN POWERS:

*Resistance to Heat:* Monstrous rank.

*Heat Emission:* Amazing rank.

*Molecular Conversion:* They have the Remarkable ability to transform metal into ash.

*Spray:* Lava Men can create Excellent intensity gusts of volcanic ash.

## MOLOIDS and TYRRANOIDS

F	TY	(6)	Health: 32
A	TY	(6)	
S	GD	(10)	Karma: 10
E	GD	(10)	
R	TY	(6)	
I	FE	(2)	
P	FE	(2)	

### KNOWN POWERS:

*Abnormal Sensitivity:* These races can see in the dark but are blinded by normal light.

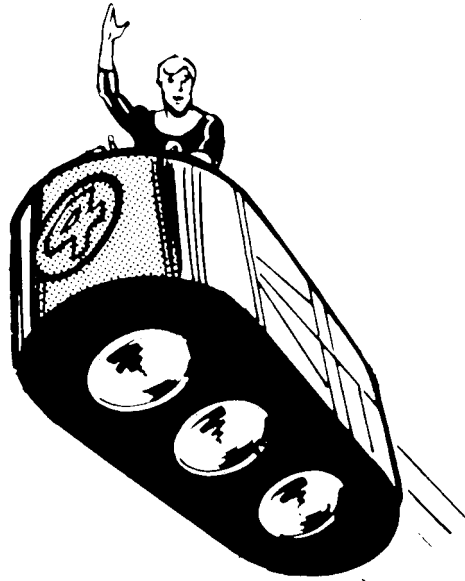

## WAKANDA

This northern African nation is home to T'Challa, the Black Panther. It is a small, prosperous country that manages to mix its tribal past with the modern technological world. The Wakanda tribe derives great revenues from the sale of Vibranium, the rare metal that absorbs vibration; Wakanda has a virtual monopoly on the metal. A sacred hill contains an immense lode of the metal. By selling small amounts of it, the Wakanda tribe has amassed a fortune large enough to make up for their lack of an industrial base.

The culture remains tribal. The tribespeople prefer to maintain their traditional dress and customs. However, they are trained in extremely modern technology and have created such wonders as a flying car and a gigantic robot panther.

The Black Tower of M'Kumbe rises 1000 feet above the Wakandan jungle. The tower is a forbidden area and with good reason—the pseudo-Roman colony run by Gaius Tiberius Augustus Agrippa

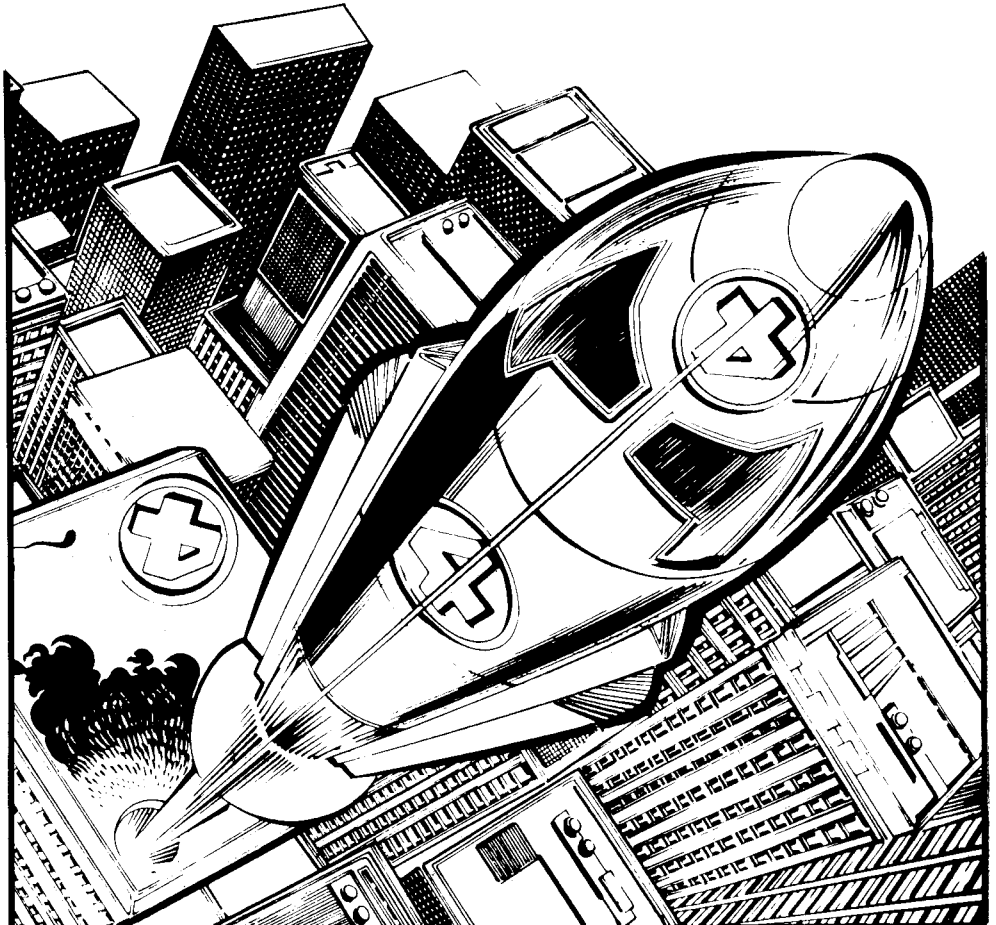

was hidden inside it. For centuries he had kidnaped Wakandans and brainwashed them into his "Roman" subjects. Agrippa's colony was destroyed shortly after the FF discovered its existence.

### WUNDAGORE MOUNTAIN

This mountain in the Balkan country of Transia has a long history of occupation by supernatural and superhuman beings. In the Sixth Century AD, the mountain was the site where Morgan Le Fey and her magical cult of Darkholders summoned the Elder God, Cthon. After discovering he was too powerful for their control, they managed to imprison him within the depths of the mountain.

In the twentieth century, Wundagore was chosen as the site for a laboratory where Herbert Wyndham (see High Evolutionary) and Jonathan Drew studied accelerated evolution. They discovered and exploited the rich veins of uranium found within the mountain. The profits were used to built a citadel of advanced scientific research. In this citadel, Wyndham eventually became the High Evolu-

tionary. He created the New Men, animals who had been transformed into demihumans. When he became aware of Cthon's malevolent presence within the mountain, Wyndham organized the New Men into the Knights of Wundagore. Drew's daughter Jessica acquired radiation poisoning during her childhood here; this forced Wyndham to place her into suspended animation and begin the process that eventually transformed her into Spiderwoman I. Eventually the High Evolutionary rebuilt his citadel into a starship; he and the New Men left Earth for space. One of his New Men, the maternal Bova, stayed behind in a cottage to care for the still-sleeping Jessica.

In the following years, Wundagore became the site of several battles involving Morgan Le Fey, her former follower the magician Magnus, Cthon, and Mo-

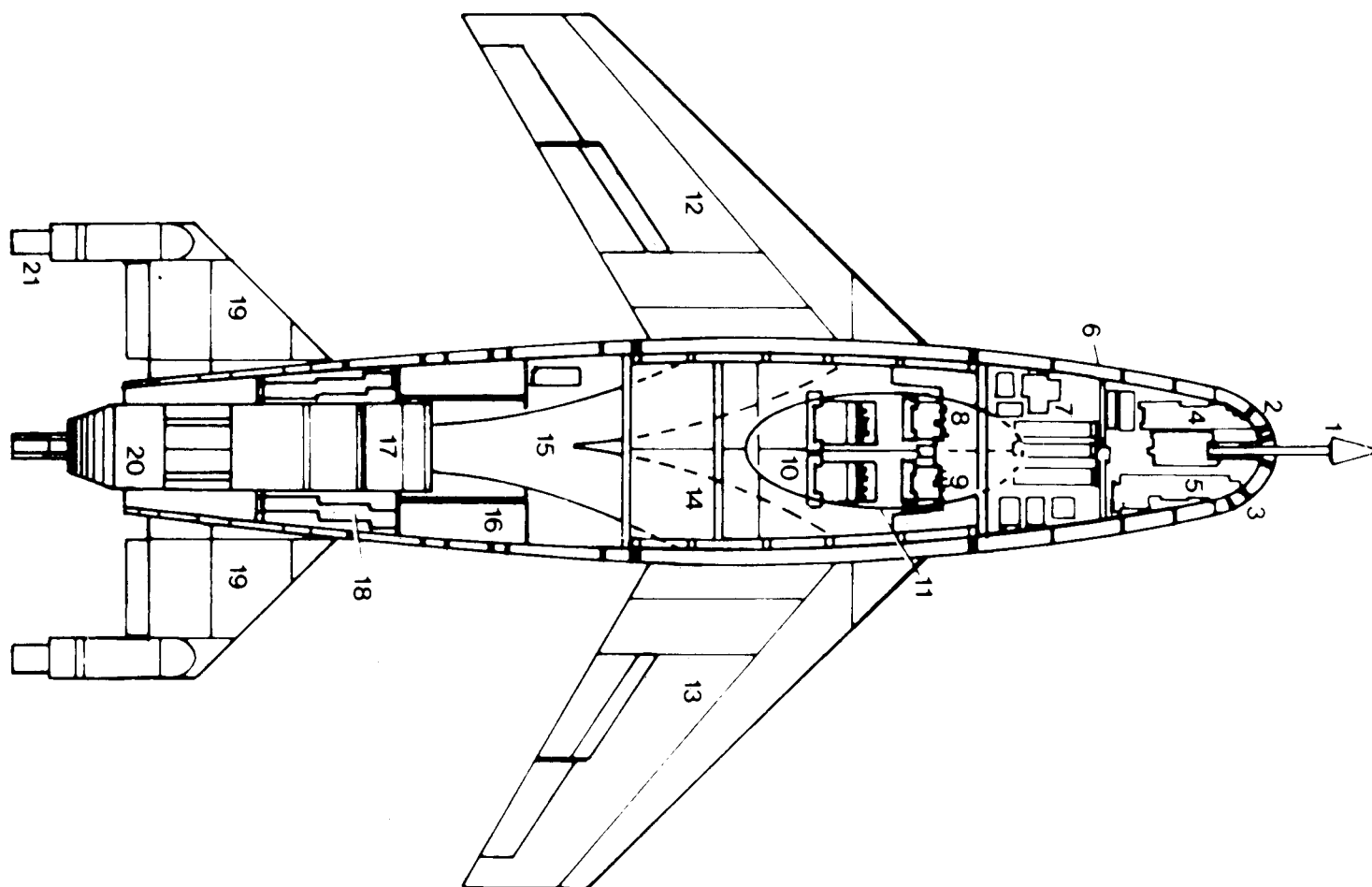

dred the Mystic, Spider Woman, and the Avengers.

Today the mountain is abandoned. The desolate launching cradle and the ruins of Bova's cottage are all that remain. However, occasionally relics of past occupants surface. The Black Knight's Atomic Steed is one such relic.

## NEW MEN

### Knights of Wundagore

Physical ranks	Vary
R	GD (10) Karma: 30
I	GD (10)
P	GD (10)



(Note: The physical ranks are equal to those of the original animal the New Man was created from. For example, a Lupinoid would have Excellent Fighting and Good ranks for the rest.)

#### KNOWN POWERS:

*Demihuman Form:* All New Men are animals who were transformed into demihuman beings. Despite the original size of the animal, the resultant New man is about the size of a normal adult human. However, each New Man has an appearance that retains distinctive traits of its original form.

*Natural Weaponry:* The New Men retain such features as fangs, claws, and horns.



**Body Armor (Tech):** Each Knight is equipped with a suit that gives him excellent protection against physical attacks. **Atomic Steeds:** These flying mounts weigh 2750 pounds. They can support an additional 450 pounds. Maximum speed is Shift-X airspeed and maximum range is 37,000 miles.

They are extremely maneuverable; in game terms they possess the pilot's Dexterity.

**RUNNING A NEW MAN:** Both the New Men and the Knights display personalities reminiscent of their animal origins. Most are loyal to the High Evolutionary; a rebellion occurred but was swiftly put down when the High Evolutionary devolved the rebels back into animals. Individuals are bright and compassionate.

## XANDAR

This is a world in the Andromeda galaxy on the edge of the Skrull Empire. The Xandarians developed a highly advanced technological society. The center of their civilization were the Living Computers, immense computer banks that incorporated the minds of Xandar's most brilliant thinkers.

Unfortunately, Xandar's glory was also its most irresistible treasure. The warlord Zorr attacked Xandar for its energy and nearly completely drained it. The planet crumbled into asteroid fragments. Fortunately, a Watcher lent his aid. He formed atmosphere-retaining force fields around the four fragments bearing Xandar's largest cities. Then he set the four asteroids in a diamond formation and set it adrift into space. The Xandarians soon learned how to pierce the force fields and connect the four asteroids with immense tunnels. They rearranged the asteroid-cities for greater efficiency. One held the city, the second the factories, the third the farms, and the fourth was stripped as a mine.

In the following years the Xandarians developed a defense force of superhumans called the Nova Corps to defend it against new threats. Although they were extremely powerful, the Nova Corps was no match for the Skrulls who had come to seize the Living Computers. The intervention of the FF and other superhumans from Earth, as well as R'Kill's assassination of Emperor Dorrek, finally caused the Skrulls to break off the attack.

The Living Computers assisted the Sphinx to attain incredible powers. They also unknowingly assisted the disem-

bodied mind of Dr. Sun to become powerful enough to seize the newly-built H.E.R.B.I.E and later the Baxter Building's central computer.

The civilization was recently destroyed by the supervillainess Nebula.

### NOTABLE XANDARIANS

**Adora:** Queen of the Xandarians.

**Gabriel Lan:** Captain of Xandar's first starship, the Way-Opener, and later Galactus' second herald, Air-Walker.

**Pyreus Kril:** Former Nova Corpsman, first officer of the Way-Opener, and later Galactus' herald, Firelord.

**Rhomann Dey:** Nova Prime-Centurion who pursued Zorr to Earth. There he destroyed Zorr and passed his powers on to Richard Rider.

**Tanak Valt:** Former Nova Prime-Centurion and Adora's lover.

**Thoran Rul:** Nova Prime-Centurion later transformed by the Living Computers into the Protector.

**Master Xar:** Xandar's chief scientist and Adora's advisor.

### LIVING COMPUTERS OF XANDAR

F	N/A	Health: 3000
A	N/A	
S	N/A	Karma: 5000
E	CL3000	
R	CL1000	Resources: CL1000
I	CL1000	
P	CL3000	Popularity: 100

### KNOWN POWERS:

**Cyborg Body:** The core of the Living Computers are the special nutrient tanks that maintain the brains of Xandar's most brilliant thinkers.

**Computer Body:** The rest of the Living Computer is a mile-high tower of micro-circuitry.

**Power Creation:** The Living Computers have the Shift-Z ability to give superpowers to normally powerless beings. This is how they create the Nova Corpsmen.

**Power Transferral:** They can transfer existing powers from one being to another with Shift-Z ease.

In addition, the Living Computers have the following Mental powers, all at Shift-Z rank:

Clairaudience  
Clairvoyance  
Communicate with Cybernetics  
Cosmic Awareness

Iron Will  
Linguistics  
Mental Probe  
Mind Transferral  
Neural Manipulation  
Power Control  
Remote Sensing  
Sensory Link  
Telepathy  
Telelocation

**TALENTS:** The Living Computers contain the entire range of Xandarian knowledge.

**CONTACTS:** They are devotedly served by the Xandarians and the Nova Corps. They have assisted the FF

**BACKGROUND:** The Living Computers are a cyborg computer incorporating the living brains of Xandarian geniuses and a mile-tall tower of circuitry.

### RUNNING THE LIVING COMPUTERS:

They are computers. They are self-aware and possessing personalities reminiscent of their original bodies.

The FF have had a long-running fascination with vehicles of all types. This is understandable in light of the the FF's backgrounds (Reed and starships, Ben and piloting, Johnny and race cars). Unlike most super-hero teams, the FF have the ability to design and build their own vehicles. This is convenient since the FF's vehicles have a habit of being destroyed.

### FANTASTICAR

The term refers to a series of flying vehicles used by the FF over the years. All the vehicles of this series carry several passengers and can break into independently-powered modules for individual flight.

Model 1 is affectionately known as "The Flying Bathtub." This open-canopied vehicle can carry four adults or about 1200 pounds of mass. It has Poor flying speed (60 mph) and a range of 200 miles. It is primarily used for inner city use or short trips to surrounding areas. The Tub breaks into four rectangular boxes. Each compartment has Feeble airspeed (30 mph) and a range of 100 miles.

Model 2 is the advanced model designed by Johnny Storm. While it is open-canopied like its predecessor, at least this one has windshields. The four passenger modules attach to a central engine core. Each module can carry two



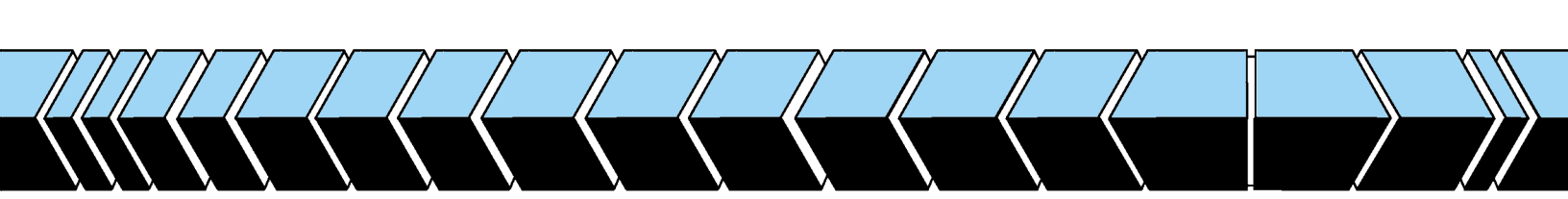

passengers for a total of eight. The side modules can detach to form miniature jetplanes. These mini-plane modules have Incredible airspeed (350 mph), a ceiling of 38,000 feet, and a range of 400 miles. The entire vehicle has Monstrous airspeed (550 mph), a ceiling of 30,000 feet, and a range of 1000 miles.

Model 3 was recently completed. It is similar to Model 2 except that it has fully enclosed compartments and more powerful engines. The entire vehicle has Shift-X airspeed (1000 mph), a ceiling of 40,000 feet, and a range of 1500 miles. The mini-plane modules have Monstrous airspeed, a ceiling of 45,000 feet, and a range of 500 miles.

#### **FANTASTICOPTER**

In their early days, the FF owned a helicopter. This vehicle carried 6 passengers at Good speed (150 mph) for a range of 200 miles. While the Fantasticopter had better abilities than the Flying Bathtub, this little-known vehicle was almost immediately rendered obsolete by the Model 2 Fantasticar.

#### **INTERCONTINENTAL PASSENGER MISSILE**

This is an ICBM that Reed modified for use as an ultra-fast long range craft. It was primarily intended for trips to remote regions where refueling would be impossible or for short space flights. It possesses fold-out wings that deploy on command after lift-off or in an emergency if the ship loses power. The ICPM carries eight passengers and an additional ton of cargo. Its cargo compartment is designed to haul the Model I Fantasticar. The ICPM is designed for VTOL and contains special landing gear to keep it upright on tilted terrain.

The ICPMs were originally launched from a silo in the Baxter Building. However, the FAA finally stopped this practice. When the Four Freedoms Plaza was designed, Reed secretly included an improved silo but it requires lengthy preparation before it can be used. The ICPM now sits exiled on the Avengers' Hydro-Base.

#### **NEGATIVE ZONE EXPLORER, MODEL I**

This peculiar ship is a baby starship designed for use within the Negative Zone. It draws its power from the anti-matter that forms the Negative Zone. The Explorer carries four passengers in tight conditions. The entire Explorer unfolds like flower petals to release its passengers. Inside the Negative Zone, the Explorer has CL5000 speed (1000 times lightspeed) in space and Remarkable airspeed. Recycling systems maintain the air. Food is limited to a five month supply of concentrates.

The Explorer was left behind on the Negative Zone world of Mantracora.

#### **POGO-PLANE**

This is the FF's original long-range vehicle. This VTOL aircraft is capable of swift intercontinental flights. Unlike the Fantasticars, the Pogo Plane has ample cargo room. The "Flying Bathtub" is designed to fit easily within the aft cargo compartment. The Pogo-Plane can land in any soil condition; special landing gear keeps it upright no matter how the terrain leans. While the Pogo-Plane is primarily jet powered, it has a back-up rocket system that enables it to make limited space flights. The original Pogo-Plane had Unearthly airspeed (600 mph) and a range of 15,000 miles. The current Pogo-Plane has Shift-Y airspeed (1200 mph) and a range of 2170 miles. Currently the Pogo Plane shares a hangar with the ICPM at Stingray's Hydro-Base.



### **REDUCTA-CRAFT**

This bottle-shaped vehicle is used for exploring the Microverse. The front passenger module has a canopy that protects four passengers. The engine module contains the propulsion system (CL1000 speed) and Shrinkage device (CL5000 rank). The Reducta-Craft sits in the FF's headquarters.

### **SKRULL STARSHIP**

This is a small starship given the FF by the new Skrull Emperor. It has three engines, a sizable flight compartment, and room for twenty or more passengers. It can carry a total payload of four tons. The ship has an onboard Astro-navigation system that takes care of piloting the ship between stars. No Astro-Navigational skill is needed to pilot it. The ship has CL1000 speed (10,000 mph in the air, 1,000,000 mph in space) and a Hyperdrive engine that can transport it nearly instantly anywhere in the nearby galaxies. This vehicle is kept at the FF's hangar on Hydro-Base.

### **SKY-CYCLES**

The term refers to a series of open-framework flying vehicles used for short-range trips. The basic design is an arrangement of fuel tanks and engine fans topped by a saddle and control bars. While the Sky-Cycles are slower and have less range than the Fantasticars, they have the advantages of being quieter, lighter, and more fuel efficient.

The one-man version is in effect a stripped version of the Model 1 Fantasticar. It has Feeble airspeed (30 mph) and a range of 20 miles.

The multi-passenger version can carry up to four passengers at Poor speed (60 mph) for up to 50 miles.

## FROM THE BEGINNING COMES THE END!

A Fantastic Four Adventure by David Edward Martin

The following adventure was originally conceived as part of *The Fantastic Four Compendium*, my second book for TSR, published in 1987. The first two books in the MA series had a small adventure as the final chapter. Mine was originally expected to follow that pattern. Using Gormuu as the hook and Four Freedoms Plaza as the setting, I started to assemble the adventure that follows.

As things turned out, I was running out of room in my manuscript for the proposed adventure. Fine. I put the uncompleted adventure aside and filled the rest of the book with other things. The adventure's only copy, the original manuscript printout, sat unread in a fat orange binder on the back of a storage shelf.

Until now.

What follows is the adventure as it might have appeared, had I finished it and inserted it into *The FFC*. Note that this is an early draft more akin to my thoughts on what should happen rather than a clear outline for the Judge to use in gaming. This still needs some work. Feel free to modify it however you want. For example, you might consider updating it to reflect the current FF setting.

Note that the adventure runs a lot fairer to the players if they have a copy of *The FFC* handy. After all, Gormuu has only made three appearances in print. If either Reed Richards or Sue Richards are being run as PCs, the Judge should covertly prepare them for this adventure by somehow making sure those players read the Gormuu entry, say a week or a month before the actual gaming session occurs. Be subtle; give them the info they will need buried in with a bunch of other stuff. For example, leave the Gormuu issue of *Fantastic Four* out with the rest of your comics where your gamers can read it.

As for playing the adventure, well, this thing is a custard pie with a vial of nitroglycerine in it. Gormuu and the rest of the NPC antagonists are not exactly world-threatening and are a bit on the goofy side. While this is not exactly a humorous adventure, it's far from being grim and gritty! The only real threat is the timebomb of Gormuu's uncontrolled shrinking but players ignore that at the risk of wiping out the center of the Marvel Universe..

And now, for the first time ever,  
"From the Beginning Comes the End!"

### INTRODUCTION

This mini-adventure is included in the book to give you a crash course in the history and "feel" of the *Fantastic Four*. Although it is set in the present day, it can be used with any of the teams of the FF. It can even be run using player-generated characters, assuming they are somehow connected in your campaign to the FF's extended family. However Reed Richards should be present in some manner in this adventure, either as a PC or NPC.

The adventure can easily be inserted into the Judge's current campaign since it is self-contained. The only problem a Judge could have is if the PCs blow the adventure. In that case, the PCs next adventure will require a new headquarters.

### BACKGROUND

The scenario revolves around Gormuu the Infinite Monster. As the reader now knows, Gormuu was Reed's first major foe. Reed defeated Gormuu by turning the monster's powers against him, devising a Power Beamer to affect Gormuu's self-enlarging power. Gormuu rapidly increased in size to the point where he had less substance than an interstellar gas cloud. Reed never publicly revealed how he defeated Gormuu. Perhaps he thought an insane individual might destroy the Power Beamer and somehow return Gormuu to Earth. He also suspected that Gormuu might someday return to Earth when his power to

expand ran out. For this reason, Reed continued to operate the Power Beamer over the years, knowing Gormuu would still absorb the energy and continue to grow. Reed took the Power Beamer with him when his newly formed *Fantastic Four* set up their Baxter Building headquarters. The Power Beamer took up residency in Reed's 33rd floor laboratory.

The Terrax the Untamed destroyed the Power Beamer along with the rest of the 33rd, 34th, and 35th floors. As soon as the crisis past, Reed rebuilt the Power Beamer and switched it on.

Gormuu continued to grow.

Since the Power Beamer operated automatically and was self-maintaining, Reed spent little time on it. The others even forgot its existence, if they had even known about it at all. Then one day Reed himself forgot about the Power Beamer's existence.

When Reed's mind was transferred in the Mantracore computers in the Negative Zone, he lost parts of his memory. Little things that might have been important but he hardly ever thought of, things like the color of his mother's eyes or who his childhood playmates were or the reason for the Power Beamer's existence.

The loss became critical when the Baxter Building was destroyed by Doctor Doom. When Reed built Four Freedoms Plaza and recreated most of his lost equipment, the Power Beamer remained forgotten and unrestored.

Gormuu stopped growing.

At this point Gormuu was larger than the Milky Way galaxy but so diffused as to be undetectable. He began to shrink, slowly at first, then faster as the energy that had held his atoms apart disappeared. He was like an infinite rubber band that had begun to spring back.

Enter the Wizard into our story. He had been lying low of late, engaged in an exhaustive study of Reed Richards' life and works. He hoped that somewhere in Reed's past he would discover some useful bit of information, something that would enable him to finally beat the FF. A chance discovery of Reed's long-abandoned lab notes from his Central City, California, days told the Wizard how Richards defeated Gormuu. The Wizard curiously tested Reed's theories about Gormuu. He was puzzled that he could find no trace of the Power Beamer's energy signature but he did find traces of Gormuu. The Wizard realized Reed was right. Gormuu was coalescing and that he would return to his original size in only three weeks!

The Wizard hit upon a plan to exploit his discovery. Gormuu would be the tool that would enable the Wizard to loot the Four Freedoms Plaza. While the Wizard had no doubt that the FF would defeat Gormuu, they would be distracted long enough for the Wizard to steal anything he could.

The Wizard made one alteration in events. His research showed Gormuu was shrinking toward the site he had been enlarged so long ago, Central City California. The first step in the Wizard's plan called for Gormuu to be redirected toward New York City, the FF's current home. The Wizard devised an Energy Lure that relocated the focus point of Gormuu's shrinkage to the Four Freedoms Plaza. One week before this adventure begins, the Wizard managed to sneak onto the FFP's 51st floor and hid the energy lure in the ventilation system.

The Wizard had theorized that when Gormuu reformed, his peculiar atomic nature would wreak havoc with the delicate electronics and high-tech systems of the FFP. Although this wouldn't directly aid the Wizard, such mishaps should keep the FF busy, perhaps too busy to notice what was about to befall them. These strange events will begin to happen three days before Gormuu reappears.

Unbeknownst to the Wizard, the Energy Lure was having an unexpected effect on Gormuu. Rather than stop at his original height of 25', Gormuu would now continue to shrink uncontrollably. After a brief stop at 25', Gormuu will begin to shrink until his atoms collapse into a ball of neutronium. One day after Gormuu's return, the FFP will be completely destroyed and the entire Earth placed in severe peril.

The adventure begins at a point when the FF are between crises. They are scattered around the FFP doing whatever they do in their off-hours.

## TIMETABLE

G-?	Power Beamer destroyed
G-21 days	Wizard discovers Gormuu's existence
G-7 days	Wizard plants Energy Lure in FFP
G-5 days	Starcore detects a freak nebula
G-3 days	The Thing's exercise equipment goes berserk
G-2 days	Fantasticars out of control
G-36 hours	H.U.B.E.R.T. goes awry
G-30 hours	Negative Zone portal leaks anti-matter
G-24 hours	Trapster invades the FFP
G-15 hours	Microverse starships invade the FFP
G-13 hours	Starcore notifies the FF
G-11 hours	Mutant warriors come through Time Machine
G-10 hours	Gormuu visible in daylight
G-4 hours	Gormuu 1 mile tall but still intangible
G Hour	Gormuu solidifies at 200'
G+15 minutes	Wizard penetrates the FFP; Gormuu 100'
G+30 minutes	Gormuu 50'
G+1 hour	Gormuu 25'
G+2 hours	Gormuu 12'
G+3 hours	Gormuu 6'
G+4 hours	Gormuu 3'
G+5 hours	Gormuu 20"
G+6 hours	Gormuu 10"
G+7 hours	Gormuu 5"
G+8 hours	Gormuu 2"
G+9 hours	Gormuu 1"
G+11 hours	Gormuu .25"
G+13 hours	Gormuu .0625"
G+15 hours	Gormuu .015"
G+18	Gormuu .001"
G+21 hours	Gormuu .00001
G+24 hours	Neutronium. FFP implodes.

## ENCOUNTER 1

### No Pain No Gain!

*Summary:* Ben and other superstrong team members are exercising in his special gym when interference from Gormuu causes the equipment to malfunction.

*Starting:* Ben and any superstrong characters are in the gym. Less strong characters may watch if they want. The strongmen are in the middle of their routines when trouble begins.

*Encounter:* All the superstrong PCs are using various pieces of equipment. The devices are designed to equal the PC's strength as increased pressure is applied by the exercising PC. If only one PC is exercising, he is using the Reverse Polarity Force-Resistor. This is a pair of electromagnets that strap to the PC's wrists. The devices possess Monstrous Magnetism. They alternately attract or repel each other; they switch when the PC

successfully resists their power. The devices are built of Remarkable Material.

If another PC is exercising, that PC is using the Isometric Lift Bar. This is a horizontal bar attached by cables to the floor. Pressure on the bar causes the bar to pull towards the floor. The intensity of the pull is +1Cs higher than the PC's grip on the bar. The apparatus is made of Amazing Material. When the trouble starts, the bar suddenly gains +3CS Strength and pins the PC to the floor. The PC must destroy th bar or lift it away long enough to free himself.

Meanwhile, the Force-Resistor switches to repelling. A power surge raises the rank to Monstrous. Whoever is using them must break free of at least one of them or risk being torn in two. Once one half is disabled or removed, the other flies in a straight line at Typical speed. The device will try to smash through any barrier, dragging the PC with it. Eventually the PC may find himself in mid-air outside the FFP. The device will continue its flight in a descending arc, touching down 3 miles away.

*Aftermath:* An examination of the remaining exercise equipment shows nothing. The other devices operate normally.

## KARMA:

Defeating the threat	+20
Assisting a trapped PC	+10

## ENCOUNTER 2

### Fly the Friendly Skies!

*Summary:* The PCs battle runaway Fantasticars.

*Starting:* It is one day later. One or more of the PCs are patrolling Manhattan in a Mark III Fantasticar when they receive the Mark I Fantasticar's emergency signal. The Mark I is in th FFP's hangar and not in use. The other PCs may be anywhere in the FFP.

*Encounter:* The PCs are engaged in a routine flight over Manhattan. The Mark III has operated smoothly thus far. Then the alarm sounds. It is the Mark 1 "Flying Bathtub," last seen sitting parked in the hangar of the FFP. Attempts to radio either the Mark I or the FFP get only static.

Two areas from the FFP, the Mark III begins to malfunction. The difficulty of piloting the vehicle increases each moment. The initial difficulty level requires a Good Intensity FEAT. The PCs must make an Agility FEAT each turn to maintain control of the vehicle. Failure means the difficulty increases +1CS. If the PCs retain command of the vehicle long enough, they can activate the hangar doors and land at the FFP. However, the hangar door control is linked to the Mark III and is as difficult to operate.

When the PCs enter th hangar, they find th

Mark I flying in erratic circles around th hangar. After the first PC attempts to control the vehicle, it begins to head in random directions, changing direction each turn. The difficulty of controlling the Mark I is equal to whatever the last rank was for the Mark III. If the PCs attack the Mark I, it immediately breaks into its four modules. Each modules continues to fly around the hangar, randomly changing directions each turn. If the hangar door is still one, some of the vehicles may fly outside. When they are two areas beyond th FFP, they will slow to a hover and gradually settle to the ground 3 areas away from th FFP.

All the affected vehicles still within two areas of the FFP will fly 1 hour before they settle to the ground.

*Aftermath:* Again, a check of the vehicles reveals no tampering or lingering interference.

If the PCs check for records of strange energy emissions, the sensors in Reed's lab show strange particles present about the time of the troubles in the lab and hangar. If the PCs check with Starcore, they will learn a strange nebula has appeared around the solar system and that it is coalescing rapidly.

## KARMA:

Successfully grounding an undamaged vehicle	+10
Successfully grounding a damaged vehicle	+5
Destroying a vehicle	-10
Contacting Starcore	+30

## ENCOUNTER 3

### Are You? Are You Are?

*Summary:* The HUBERT series robots are affected by the increasing distortion of Gormuu.

*Starting:* The PCs can be in any part of the FFP they want. This is a floating encounter because the HUBERTs will come after them!

*Encounter:* It's been eight hours since the Fantasticars went crazy. The worst of the debris has been cleaned up. The PCs have begin to relax when HUBERT arrives and requests instructions. It appears to be planning the next day's activities. However, the robot is beginning to suffer malfunctions. The first indication is when it addresses a PC by the wrong name. When it repeats the PC's instructions it mangles the words. If the PCs question HUBERT's accuracy, the robot suggests the PCs are impostors. If the PCs try to disable HUBERT or flee, th robot declares they are impostors and will attack them as if the PCs were supervillains. If the fight continues for another 20 turns, a second HUBERT appears. If the fight continues 20 turns after that, a third HUBERT appears, carrying a spray canister full of paralyzing foam. This foam has Incredible Intensity; failure to make



an Endurance FEAT means the PC is totally paralyzed for 1-10 hours or until given the antidote.

*Aftermath:* Two hours later the surviving HUBERTs return to normal. Their programming remains full of glitches but a check of their diagnostic circuits reveals a power surge. If the PCs contact Starcore, they learn of a green and red nebula has surrounded Earth and is coalescing rapidly.

#### **KARMA:**

Safely subduing the first HUBERT	+30
Subduing all the HUBERTs	+35
Destroying a HUBERT	-10
Destroying all the HUBERTs	-20
Contacting Starcore	+20

#### **ENCOUNTER 4**

##### **We Unlock the Door of Imagination!**

*Summary:* The Negative Zone Portal is leaking. Random blasts of destructive rays shoot through the FFP, forcing the PCs to enter the lab and shut down the Portal manually.

*Starting:* It's been six hours since the HUBERTs went berserk. The damage has been cleared away. By now the PCs should be getting a little jumpy. Something is happening but unless the PCs contact Starcore they have no idea of the real cause of the strange events.

Suddenly an alarm sounds. If the PCs check, they discover it is a malfunction in the Negative Zone Portal's locking mechanism. Suddenly there is an explosion, followed by a sizzling sound. The Portal has begun to open, releasing minute quantities of antimatter in the form of destructive rays. The rays go in random directions from the Portal, spreading out in a 120 degree cone from the Portal's front side. The rays have an initial destructive intensity of Excellent to Monstrous rank (random choice of rank for each ray). The rank decreases -1CS for each wall or floor penetrated. Any target of the beam has a quarter-inch hole neatly drilled in it. Living targets suffer power rank damage in the form of a cauterized wound. Flammable materials may catch fire from the blast.

Normally the Portal can be shut down by the master computer. Unfortunately for the FF, one of the first beams severed the remote control cable. The Portal will now have to be shut down manually. This can be done by an Excellent intensity Reason FEAT or by attacking the Portal directly. Destroying the Portal automatically severs its connection to the Negative Zone. The Portal is made of Remarkable material.

While the PCs are in little danger if they remain away from the Portal chamber, the risk increases with proximity. Beams fire once every 1-10 turns.

When the Portal has been shut down, the beams cease. If the PCs do not shut the

Portal down, it shuts itself down automatically when Gormuu solidifies 30 hours from now.

*Aftermath:* Depending on how long the Encounter occurred, the FFP may be riddled with wormholes and fire damage. Checks on the FFP's sensors show another energy peak occurred shortly before the Portal started leaking.

A check with Starcore informs the PCs that a green and red gas cloud roughly 200,000 miles wide has surrounded Earth and is shrinking rapidly. Computer projections suggest a five-pointed shape, like an irregular pentacle or a crudely-drawn hominid.

#### **KARMA:**

Shutting down the Portal	+30
Destroying the Portal	+10
Checking with Starcore	+10
Deducing the cloud is Gormuu	+100

#### **ENCOUNTER 5**

##### **A Sticky Situation!**

*Summary:* The Trapster takes advantage of the situation to invade the FFP and kidnap Roberta, whom he holds a grudge against for defeating him once before. (He has no idea she's a robot linked to her desk.)

*Starting:* It is six hours since the Negative Zone Portal ventilated the building. The PCs have had a chance to repair some of the damaged equipment and severed cables. While they were busy inside the building, the Trapster has been walking up the outside wall. He broke in through a ventilation duct on the 70th floor. He has just tripped an alarm on the 71st floor.

The security system is still damaged. A Reason FEAT of Excellent is needed to get the computer to locate the intruder. A second FEAT is needed if the computer is asked to show or identify the intruder.

The Trapster intends to enter the Reception area and take Roberta hostage. During their previous encounter he never saw that Roberta was a robot that only looks human from the waist up. His first actions are to boobytrap the elevator door that leads to the upper floor. Then he will seize Roberta and head for the ground level by way of the visitor elevator's shaft. It takes the Trapster 5 turns to set the trap. He then takes another 5 turns before he confronts Roberta. Normally the floor of the Reception Area has a Stunning electroshock capability but because of the damage to the building, this function is disabled. Two turns after he first threatens Roberta, the Trapster finally realizes she's a robot. He will try to flee down the elevator shaft by standing on the underside of the car.

If the PCs capture the Trapster, he will be evasive about his purpose in breaking in. He will do anything to avoid admitting he just tried to kidnap a robot. He will even slyly

admit to anything the PCs accuse him of. He will quickly realize that they are having some kind of problem and he thinks he may be able to use their confusion to his advantage.

*Aftermath:* The Judge can use the Trapster as a red herring to let the PCs delude themselves into thinking they've caught the culprit. Indeed, there is a longer lull before the next Gormuu-influenced event.

If the PCs check with Starcore, they learn the Earth has been touched by a green and red cloud in an irregular five-pointed shape. The cloud measures 3000 miles across its widest point. The cloud appears to be centered on the East Coast.

#### **KARMA:**

Capturing the Trapster	+30
The Trapster escapes	-20
Being defeated by the Trapster	-40
Contacting Starcore	+5
Deducing Gormuu's role	+50

#### **ENCOUNTER 6**

##### **Ah, You Can See the Wires!**

*Summary:* An accidental firing of the Reducta-craft's engine enlarged a squadron of starships from the Microverse. The starships attempt to escape, resulting in more damage.

*Starting:* The PCs have repaired the damage to the FFP's security systems. The PCs may be anywhere in the FFP, depending on how previous encounters have gone.

*Encounter:* It is 9 hours since the Trapster was first spotted. Things have been quiet since then. The PCs may even wonder if the crisis is over.

It's not. An alarm sounds. The Reducta-craft is under attack. The camera that normally shows the craft has been damaged. The PCs must physically investigate the alarm.

When they arrive at the room housing the Reducta-craft, they find the door closed but hot to the touch in places, as if fire is selectively heating the door's other side. When the door is opened, the PCs spot four football-sized starships hovering in diamond formation, firing energy weapons at the door (or rather, where the door had been before the PCs opened it).

These are actual interstellar warships from the Microverse. Each has a crew of 20 eight-inch-tall humanoids (just large enough to see unaided) and the proportional engines and firepower of a lesser Skrull starship. However, these are greatly reduced in power due to their small size. The ships have Amazing material strength, Amazing Resistance to Energy Attacks, and Good Flight. Armaments consist of Plasma Bolts of Good intensity.

The squadron was on patrol in the Microverse when the Reducta-craft accidentally fired its engines and enlarged the ships

into the Macroverse. The crew has panicked, thinking themselves under attack. Their main goal is to escape and somehow return home.

When the PCs arrived, the squadron was trying to melt its way through the lab door. They are automatically firing a new volley when the PCs open the door and enter the target area. If the PCs attack, the squadron will defend itself. If the PCs hesitate for 2 turns the squadron will attempt to fly past them into the hallway. The squadron will continue to fight or sneak their way out of the FFP. If they can get outside the building, they will shift their engines to maximum speed and disappear off into the distance, irretrievably lost.

If the PCs can convince the squadron of their good intentions and keep them from escaping the building, they can return them to the Microverse by activating the Reductacraft's engines correctly. This is a Remarkable intensity FEAT.

*Aftermath:* The squadron's crewmen want to return to the Microverse; the gigantic forms of the Macroverse frighten them. The PCs may immediately work on the problem of returning them home or concentrate on the greater problem of the mystery power surges.

#### KARMA:

Safely capturing each starship unharmed	+20
Each damaged starship	-10
Each destroyed starship	-20
Losing the starships	-30

#### ENCOUNTER 7

##### Belated Notification

*Summary:* This encounter is only used if the PCs have not yet contacted Starcore or otherwise learned of the shrinking cloud of Gormuu.

*Starting:* Depending on the results of the previous Encounters, the PCs may be anywhere. If the PCs have left the FFP, Starcore's message is automatically recorded and relayed to the PCs.

*Encounter:* An urgent message comes in from the Starcore observatory orbiting the Sun. The message alerts the PCs to the sudden appearance five days ago of a nebula surrounding the Earth. The nebula appears green in visible light, with a red band around its middle section. The nebula rapidly shrank to its present size, roughly 500 miles at its widest point. A three-dimensional projection shows a hominid shape like a gorilla. The cloud appears to be centered on New York City. If computer projections are correct, the cloud will continue to shrink rapidly over the next several hours.

*Aftermath:* If the PCs guess it is Gormuu, they

can begin building a new Energy beamer. The device requires an Amazing Reason and 6 hours to complete.

#### KARMA:

Deducing the cloud is Gormuu +20

#### ENCOUNTER 8

##### No Doubt About It; I Gotta Get Me Another Hat!

*Summary:* Nathan Richards' Time Machine has malfunctioned and drawn in several mutant warriors from an alternate post-Apocalyptic future.

*Starting:* Depending on the results of the previous Encounters, the PCs may be anywhere. If the PCs have left the FFP, the Mutant warriors will wreak a little havoc before settling down for some serious looting and a bite to eat.

*Encounter:* Security sensors show the door to the Time Machine has been breached. Seven humanoids are moving away from the room and scattering around the level. Then the camera goes dead.

The invaders are mutant warriors from Kang the Conqueror's timeline.

#### Invaders

F	EX	(20)	Health: 70
A	GD	(10)	
S	EX	(20)	Karma: 8
E	EX	(20)	
R	PR	(4)	
I	FB	(2)	
P	FB	(2)	

#### EQUIPMENT:

*Blaster Rifle:* Incredible damage

*Body Armor:* Good protection against energy and physical attacks.

**RUNNING THE INVADERS:** These are nearly mindless infantry-mutants. They will set up ambushes by the time the PCs arrive. If captured and questioned, they can only talk about a mission to infiltrate a warlord's castle. (The Judge can have fun with this and make up any story he wants.)

The invaders will initially try to ambush the PCs. Later they will try to attack in increasing numbers until the entire squad is involved in the melee.

They have no idea where they are. They think the PCs are warriors from the enemy army and that the FFP is the stronghold they were supposed to enter (though they cannot recall how they entered). Because of their confusion, the invaders will not kill the PCs, preferring to keep them alive for questioning.

*Aftermath:* If the PCs are captured by the invaders, the Judge should add additional member of the FF who arrive 4 hours later.

The Players should switch to the new PCs, at least until the first PCs can be rescued. The mutant warriors can be returned to their own time by the Time Machine, which keeps an automatic record of the date and timeline visited.

#### KARMA:

Getting captured	-20
Each invader captured	+5
Persuading the invaders to surrender	+10
Sending the invaders home	+20

#### ENCOUNTER 9

##### The Green Cloud Strikes!

*Summary:* The Gormuu cloud becomes visible.

*Starting:* Depending on the results of the previous Encounters, the PCs may be anywhere. If the PCs were captured by the previous group, skip this Encounter. If the PCs have left the FFP or are otherwise looking at a far enough distance away from the FFP, they can see Gormuu's shape. Otherwise they can only see the interior of Gormuu's surrounding immensity.

*Encounter:* With the invaders dealt with, the PCs can get back to the matter of Starcore's message. Any PC looking outside the FFP can see two translucent green clouds filling the sky like great pillars. In reality, these are Gormuu's legs. As the PCs watch, the gap between the legs grows smaller.

There are two means to see the green cloud at a distance. If the PCs fly far enough away (at least 50 miles), they can see the green clouds form a hominid shape. Flying further back will give them the perspective they need to see the entire form. The simple method is simply to turn on the television. The channels are full of excited special coverage of the mysterious cloud. Remote broadcasts from Philadelphia, upstate New York, and Rhode Island shows the cloud appears to be a green hominid wearing a red kilt. If Reed or Sue see this, they will automatically recognize Gormuu. Other PCs will have to delve through the FF's records to find a picture of the alien invader.

If Reed and Sue are not present, assume they saw the shape, recognized Gormuu, and are rushing back to the FFP.

As soon as Gormuu is recognized, PCs can begin researching ways to handle him. Reed and Sue can remember the full details of Gormuu's defeat but Johnny or Ben require an Excellent Intelligence FEAT to recall the Power Beamer. PCs can also check the FF annals for Reed's notes on constructing a Power Beamer. As soon as they gain this knowledge, they can begin building the Power Beamer.

*Aftermath:* if the PCs still don't recognize

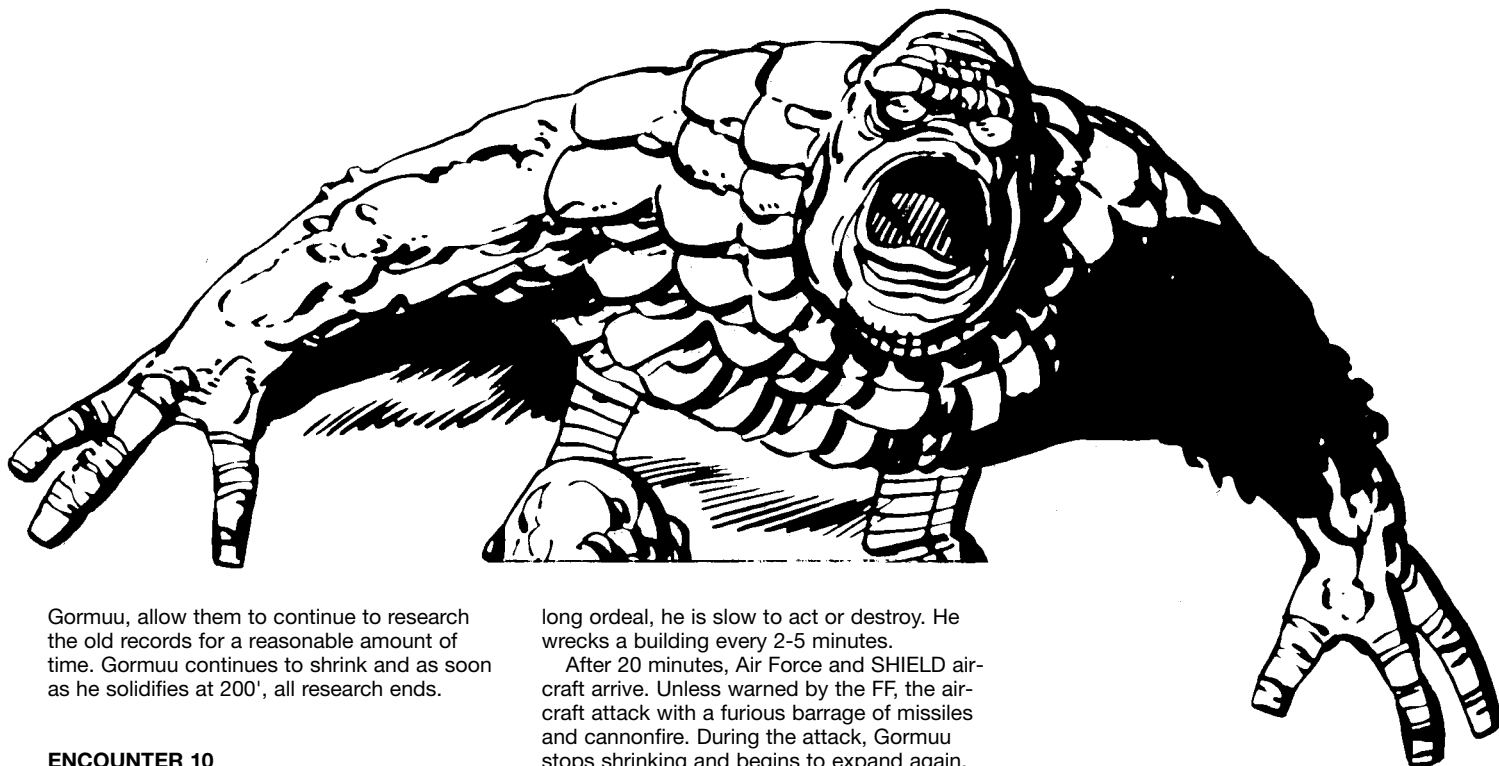

Gormuu, allow them to continue to research the old records for a reasonable amount of time. Gormuu continues to shrink and as soon as he solidifies at 200', all research ends.

**ENCOUNTER 10**  
**The Kraalo Has Landed!**

*Summary:* Gormuu solidifies at 200' tall and returns to life. The PCs must deal with a rampaging giant. Meanwhile, the Wizard breaks into the FFP (Encounter 11).

*Starting:* If the PCs were captured or incapacitated by earlier encounters, enough time has occurred for reinforcements to arrive.

*Encounter:* With Gormuu's return to life, the PCs must decide to combat Gormuu directly or work on a long-term means to defeat him. The FFP contains numerous devices that could be used to attack Gormuu, especially since Gormuu continues to shrink. The Judge should note that, because of the nature of his powers, Gormuu wants to be attacked. Gormuu will start making threatening movements and maybe smash some things in order to prompt attacks against him.

There are few ways to actually defeat Gormuu:

1. Attack him with a force greater than his Absorption Power's ability to handle. Enough attacks like this will overload and kill Gormuu.
2. Complete a new Power Bearer and send Gormuu back into space.
3. Find a way to negate his powers.
4. Don't attack him at all. He'll resume shrinking.

During the time the PCs are seeking their solution, Gormuu continues to rampage. Since he is still recovering from his decades-

long ordeal, he is slow to act or destroy. He wrecks a building every 2-5 minutes.

After 20 minutes, Air Force and SHIELD aircraft arrive. Unless warned by the FF, the aircraft attack with a furious barrage of missiles and cannonfire. During the attack, Gormuu stops shrinking and begins to expand again. When Gormuu grows another 100', the fighters recognize what is happening and break off the attack.

Once the attacks cease, Gormuu starts to shrink again. Gormuu begins the encounter 200' tall, briefly grows to 300', and starts to dwindle again. Fifteen minutes later, he has dropped to 100'. 30 minutes after that he's down to 25'. Finally an hour later he has shrunk to 12' tall. By this time the PCs should have been able to capture him without triggering new growth.

Judges must note that Gormuu never loses weight! Even when shrunken down to 12' the alien still weighs several tons. Only super-strong characters or really heavy lifting equipment should be able to budge an uncooperative or unconscious Gormuu, regardless of the alien's height.

*Aftermath:* This encounter continues until Gormuu is captured or defeated. Other Encounters can be run as intermissions since they occur simultaneously with this one.

**KARMA:**

Defeating a gigantic Gormuu	+30
Enlarging Gormuu back into space	+30
Accelerating Gormuu's shrinking	+20
Waiting until Gormuu shrinks on his own	+15

**ENCOUNTER 11**  
**The Wizard Strikes!**

*Summary:* The Wizard uses the confusion of Gormuu's attack to break into the FFP and Reed's labs.

*Starting:* The Wizard enters the FFP by way of the ventilation system. He then proceeds swiftly to the FF's floors.

*Encounter:* The Wizard is flying through the FFP's ventilation system, ascending to the FF's headquarters. He is successful in bypassing the alarms and heads to Reed's labs. He begins to loot them. He does so by attaching anti-grav disks to the chosen items and sailing them out the window. The disks are programmed to take the items to the Wizard's hidden lair.

If none of the FF are present, he can automatically grab six devices of randomly determined nature. At the end of every five minutes, the PCs make an Intelligence FEAT; success means someone noticed the string of packages flying away from the FFP.

The Wizard keeps up his looting for 1 hour. Then he runs out of anti-grav disks and decides to leave. The PCs get a final chance to spot him as he leaves the building. If they fail, he escapes without incident. If the PCs attack him, he will try to flee unless he thinks he has a chance to defeat the PCs in melee.

*Aftermath:* If the Wizard is captured the PCs may immediately turn him over to the police

or they can hold onto him for interrogation. If he is brought into the same area as the now-shrunken Gormuu, the Wizard will express curiosity about the alien. He will profess ignorance of Gormuu and say he was simply taking advantage of the confusion to do a little shopping. When Gormuu continues to shrink, the Wizard must make a series of Psyche FEATS. Failure means he cracks from the strain of worrying about Gormuu's condition. The Wizard reveals everything he knows or suspects about the ex-giant, including that Gormuu should have stopped shrinking when he hit 25' and he wonders if his Energy Lure might have caused Gormuu to continue shrinking,

**KARMA:**

Capturing the Wizard	+20
Losing equipment	-10
Letting the Wizard escape	-20

**ENCOUNTER 12**

**Down-de-Down-Down**

*Summary:* The PCs must cope with a continually shrinking Gormuu. Failure results in Gormuu becoming a mass of neutronium and destroying Manhattan.

*Starting:* This Encounter immediately follows the preceding two. The PCs have control of Gormuu or have access to whoever holds the alien.

*Encounter:* The PCs are faced with a series of questions.

What have they done with Gormuu? Is he locked away in a holding cell or have the PCs begun to examine him.

Did the Wizard admit his suspicions? If not, have the PCs arrived at the same suspicions?

Once the PCs decide that Gormuu's continued shrinkage poses a threat, they must decide upon a plan of action. They have several options, based on their powers or FFP equipment.

The worst thing they can do is ignore Gormuu's condition. If this happens, Gormuu continues to shrink until, 24 hours later, he collapses into a ball of neutronium, doing Monstrous damage to the area. A gravity well of Monstrous Strength will surround the neutronium at a radius of 1 area. Material drawn into the area will be crushed into even more neutronium, gradually increasing its area of effect.

The PCs can build a new Energy Beamer. By controlling its output, they can stabilize Gormuu's size or beam him back into interstellar space.

The PCs can launch Gormuu into deep space. While he will still collapse into neutronium, at least he'll be off planet when he does so.

The PCs can shove Gormuu through the Negative Zone Portal. Let Annihilus and

Blastaar worry about him.

The PCs can transport Gormuu into the Microverse. Again, this shifts the neutronium problem to another realm.

The PCs can negate Gormuu's powers. Since there are no known devices on hand in the FFP to accomplish this, such a device will have to be invented or acquired quickly. For example, they may want to get their hands on Forge's Neutralizer. If the PCs are persuasive enough, they may even get the Wizard to help them. Conversely, the Wizard may offer his services in exchange for his freedom.

*Aftermath:* The adventure can end in a multitude of ways. It can even be the hook for further adventures. For example, the residences of the Negative Zone or the Microverse might resent getting a new white dwarf dropped in their space. In the worst case scenario, the PCs have to deal with a mass of neutronium sitting in the middle of Manhattan, sucking in the neighborhood. This can lead to an epic engineering job using the powerhouses of the Marvel universe to deal with the gravitic monster.

**KARMA:**

Doing nothing	-100
Enlarging Gormuu again	+10
Shooting Gormuu into space	+10
Sending him into the Microverse	+10
Sending him into the Negative Zone	+10
Stabilizing Gormuu's size	+20
Removing Gormuu's powers	+50